

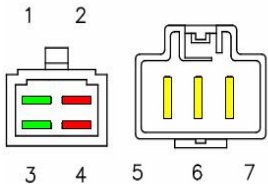









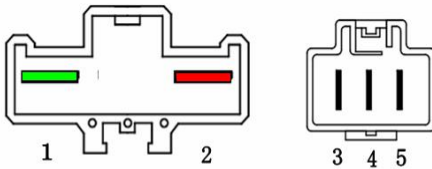

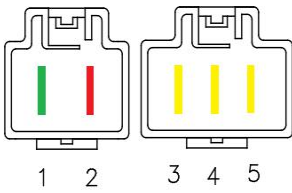

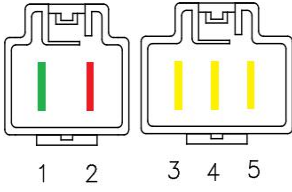

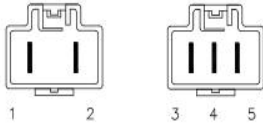

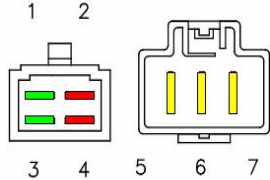

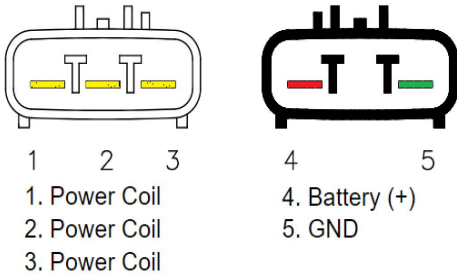
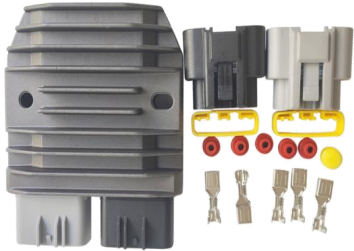
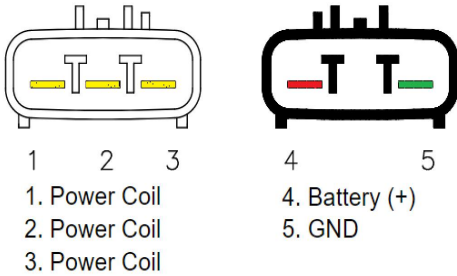

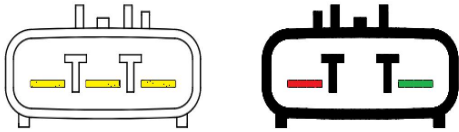



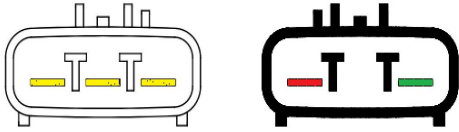
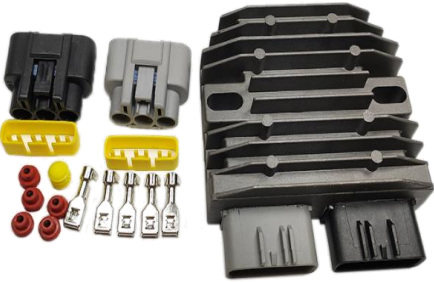
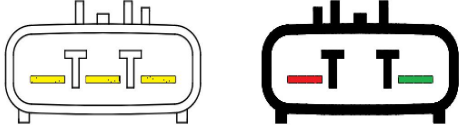

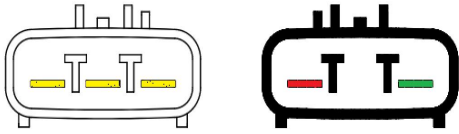

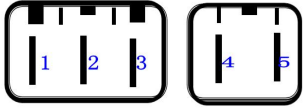

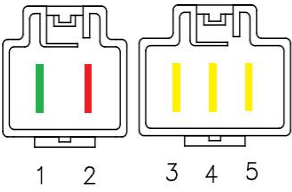

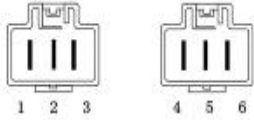

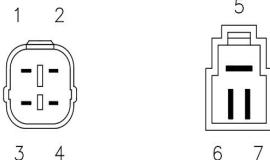

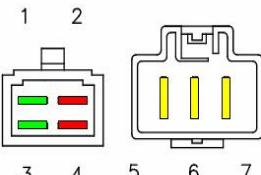

产品资料1		实物主图	接口图	适用范围
产品编号	R2001.0		 <p>1. GND 2. Battery (+) 3. GND 4. Battery (+) 5. Power Coil 6. Power Coil 7. Power Coil</p>	2404 Honda CBR RR 929 2001 2003 31600-MCJ-641 Honda CBR RE 929 2001 2003 31600-MCJ-641 Reem lazo Shin ngen SH678C-13 2414 Honda CBR RR 600 2003 31600-MEE-003 Honda CBR RR 600 2004 2006 31600-MEE-872
产品单重	300克			
检测程序	M325 2404 2414			
电线长度	黄1.5 X 20CM			
内盒尺寸	12*9.5*6CM			
外箱尺寸	49.5*25.5*30.5CM			
输出电压	14.5±0.5V 35安培			
一箱只数	50			
铝壳尺寸	90*80*25.3MM			
重要说明	安装孔距离 68MM 7线			
产品编号	R2001.0.1		 <p>1. GND (-) 2. Battery (+) 3. Power coil 4. Power coil 5. Power coil</p>	2413 Honda XL Vara ro 1000 2003 2011 31600-MBT-D21 Honda XL Vara ro ABS 1000 2004 2011 31600-MBT-D51 Reem lazo Shin ngen FH008AA
产品单重	380克			
检测程序	M325 2413			
电线插头	所有1.5 X 45CM			
内盒尺寸	12*9.5*6CM			
外箱尺寸	49.5*25.5*30.5CM			
输出电压	14.5±0.5V M50安培			
一箱只数	50			
铝壳尺寸	90*80*25.3MM			
重要说明	68MM			
产品编号	R2001.0.2		 <p>1. GND 2. Battery (+) 3. Power Coil 4. Power Coil 5. Power Coil</p>	2546 Honda VT Shadow 750 2010 2018 31600-MFE-641 Honda VT Shadow 400 2009 2016 31600-MFE-641 Reem lazo Shin ngen SH678FF 2415 Honda NSS za EX 250 2005 2007 31600-KSV-J01 Honda NSS za ABS 250 2005 2007 31600-KSV-J01
产品单重	380克			
检测程序	M325 2546 2415 2416 2417 2418 242			
电线插头	所有1.5 X 25CM			
内盒尺寸	12*9.5*6CM			
外箱尺寸	49.5*25.5*30.5CM			
输出电压	14.5±0.5V 50安培			
一箱只数	50			
铝壳尺寸	90*80*25.3MM			
重要说明	68MM			
产品编号	R2001.0.2A		 <p>1. GND 2. Battery (+) 3. Power Coil 4. Power Coil 5. Power Coil</p>	2546 Honda VT Shadow 750 2010 2018 31600-MFE-641 Honda VT Shadow 400 2009 2016 31600-MFE-641 Reem lazo Shin ngen SH678FF 2415 Honda NSS za EX 250 2005 2007 31600-KSV-J01 Honda NSS za ABS 250 2005 2007 31600-KSV-J01
产品单重	380克			
检测程序	M325 2546 2415 2416 2417 2418 242			
电线插头	所有1.5 X 25CM			
内盒尺寸	12*9.5*6CM			
外箱尺寸	49.5*25.5*30.5CM			
输出电压	14.5±0.5V 50安培			
一箱只数	50			
铝壳尺寸	90*80*25.3MM			
重要说明	68MM			

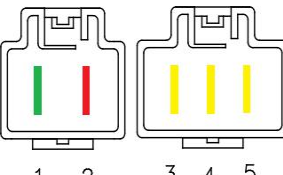



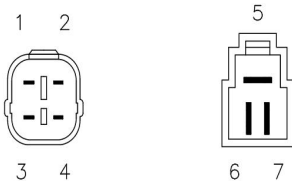

产品资料1		实物主图	接口图	适用范围
产品编号	R2001.0.3		 <p>1. Battery (+) / Bateria (+) 2. GND / Masa 3. Power Coil / Bobina de Carga 4. Power Coil / Bobina de Carga 5. Power Coil / Bobina de Carga</p> <p>2个插头一样大的</p>	2410 一黑一白尺寸插头 Honda SH300 2007 2010 31600-KTW-901
产品单重	380克			
检测程序	M325 2410			
电线插头	所有1.5 X 25CM			
内盒尺寸	12*9.5*6CM			
外箱尺寸	49.5*25.5*30.5CM			
输出电压	14.5±0.5V M50安培			
一箱只数	50			
铝壳尺寸	90*80*25.3MM			
重要说明	2个大插头,1白插头交流 1黑插			
产品编号	R2001.0.4		 <p>1. GND 2. Battery (+) 3. GND 4. Battery (+) 5. Power Coil 6. Power Coil 7. Power Coil</p>	2404 Honda CBR RR 929 2001 2003 31600-MCJ-641 Honda CBR RE 929 2001 2003 31600-MCJ-641 Reem lazo Shin ngen SH678C-13 2414 Honda CBR RR 600 2003 31600-MEE-003 Honda CBR RR 600 2004 2006 31600-MEE-872
产品单重	380克			
检测程序	M325 2404 2414			
电线插头	1.5 黄X 25CM			
内盒尺寸	12*9.5*6CM			
外箱尺寸	49.5*25.5*30.5CM			
输出电压	14.5±0.5V 35安培			
一箱只数	50			
铝壳尺寸	90*80*25.3MM			
重要说明	68MM			
产品编号	R2001.1		 <p>1. Power Coil 2. Power Coil 3. Power Coil 4. Battery (+) 5. GND</p>	2424 Can Am Comman r 1000 2011 2014 278002021 Can Am Comman r 800 2011 2014 278002021 Can Am Maverick 1000 2014 278002021 Can Am Outlan r 1000 2012 2013 278002021 Can Am Outlan r 500 2008 2013 710001191 Can Am Outlan r 800 1906 1914
产品单重	380克			
检测程序	M325 2522 2424 2425			
电线插头	3针+2针			
内盒尺寸	12*9.5*6CM或100*10*35 MM			
外箱尺寸	49.5*25.5*30.5CM			
输出电压	14.5±0.5V 50安培			
一箱只数	50			
铝壳尺寸	90*80*25.3MM			
重要说明	五针			
产品编号	R2001.1+D		 <p>1. Power Coil 2. Power Coil 3. Power Coil 4. Battery (+) 5. GND</p>	Benelli BN 302 Tornado 300 2015 2016 299066060000 Benelli BN GT 600 2015 2016 299066060000 Benelli BN 302 ABS E4 300 2017 2019 299066060000 Benelli BN 600 2014 2016 299066060000 Benelli BN R 600 2014 299066060000 Benelli BN GT E3 600 2016 299066060000
产品单重	420克			
检测程序	M325			
电线插头	3针+2针			
内盒尺寸	12*9.5*6CM			
外箱尺寸	49.5*25.5*30.5CM			
输出电压	14.5±0.5V			
一箱只数	50			
铝壳尺寸	90*80*25.3MM			
重要说明	五针			

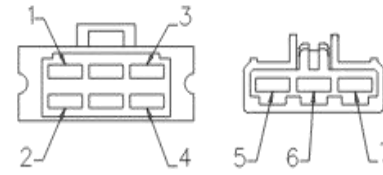
产品资料1		实物主图	接口图	适用范围
产品编号	R2001.1+DB		 <p>1 2 3 4 5</p> <p>1. Power Coil 2. Power Coil 3. Power Coil 4. Battery (+) 5. GND</p>	Benelli BN 302 Tornado 300 2015 2016 299066060000 Benelli BN GT 600 2015 2016 299066060000 Benelli BN 302 ABS E4 300 2017 2019 299066060000 Benelli BN 600 2014 2016 299066060000 Benelli BN R 600 2014 299066060000 Benelli BN GT E3 600 2016 299066060000
产品单重	420克			
检测程序	M325			
电线插头	3针+2针			
内盒尺寸	12*9.5*6CM			
外箱尺寸	49.5*25.5*30.5CM			
输出电压	14.5±0.5V			
一箱只数	50			
铝壳尺寸	90*80*25.3MM			
重要说明	五针			
产品编号	R2001.2		 <p>1 2 3 4 5 6</p> <p>1. Power Coil / Bobina de Carga 2. Power Coil / Bobina de Carga 3. Power Coil / Bobina de Carga 4. Battery (+) / Batería (+) 5. AC Output / Salida AC 6. GND / Masa</p>	2434 Kawasaki ZX 6R Ninja 600 2013 2017 21066-0716 Kawasaki ZX 6R Ninja 600 2016 2017 21066-0730 Kawasaki ZX 6R Ninja 600 2009 2013 21066-0028 Kawasaki ZX 10R Ninja 1000 2008 2015 21066-0731 Reem lazo Kokusan nki RX45
产品单重	300克			
检测程序	M325 2434			
电线插头	3针+3针			
内盒尺寸	12*9.5*6CM			
外箱尺寸	49.5*25.5*30.5CM			
输出电压	14.5±0.5V M50安培			
一箱只数	50			
铝壳尺寸	90*80*25.3MM			
重要说明	6针			
产品编号	R2001A.1		 <p>1 2 3 4 5</p> <p>1. Power Coil 2. Power Coil 3. Power Coil 4. Battery (+) 5. GND</p>	适用于: FH012AA 210660714 21066-0022 99999-0377 21066-0008 21066-0714 21066-0744
产品单重	360克			
检测程序	M325			
电线插头	3针+2针			
内盒尺寸	12*9.5*6CM			
外箱尺寸	49.5*25.5*30.5CM			
输出电压	14.5±0.5V			
一箱只数	50			
铝壳尺寸	83*94*25.7MM			
重要说明	五针			
产品编号	R2001A.1+D		 <p>1 2 3 4 5</p> <p>1. Power Coil 2. Power Coil 3. Power Coil 4. Battery (+) 5. GND</p>	适用于: 2001A.1整流器+对插
产品单重	450克			
检测程序	M325			
电线插头	3针+2针			
内盒尺寸	12*9.5*6CM			
外箱尺寸	49.5*25.5*30.5CM			
输出电压	14.5±0.5V			
一箱只数	50			
铝壳尺寸	83*94*25.7MM			
重要说明	五针			

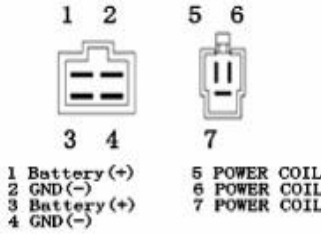
产品资料1		实物主图	接口图	适用范围
产品编号	R2001A. 1+DB	5针 	 1 2 3 4 5 1. Power Coil 2. Power Coil 3. Power Coil 4. Battery (+) 5. GND	适用于: 2001A. 1整流器+对插+保险盒
产品单重	450克			
检测程序	M325			
电线插头	3针+2针			
内盒尺寸	12*9.5*6CM			
外箱尺寸	49.5*25.5*30.5CM			
输出电压	14.5±0.5V			
一箱只数	50			
铝壳尺寸	83*94*25.7MM			
重要说明	五针			
产品编号	R2001A. 3		 1. Power Coil / Bobina de Carga 2. Power Coil / Bobina de Carga 3. Power Coil / Bobina de Carga 4. Battery (+) 5. GND / Masa	HONDA: CBR 1000RR 2008 - 2014 HONDA: CBR 1000S 2014 HONDA: NC 700 2012 - 2014 HONDA: NSA 700 2008 - 2009 HONDA: FJS 400 2009 HONDA: NSS 250 2008 - 2009 HONDA: NSS 300 2014 31600-KVZ-631 FH014AA FH021AA 31600-KVZ-631
产品单重	300克			
检测程序	M325			
电线插头	3针+2针			
内盒尺寸	12*9.5*6CM			
外箱尺寸	49.5*25.5*30.5CM			
输出电压	14.5±0.5V			
一箱只数	50			
铝壳尺寸	83*94*25.7MM			
重要说明	五针			
产品编号	R2001A. 5		 1. GND 2. Battery (+) 3. Power Coil 4. Power Coil 5. Power Coil	2546 Honda VT Shadow 750 2010 2018 31600-MFE-641 Honda VT Shadow 400 2009 2016 31600-MFE-641 Reem lazo Shin ngen SH678FF 2415 Honda NSS za EX 250 2005 2007 31600-KSV-J01 Honda NSS za ABS 250 2005 2007 31600-KSV-J01
产品单重	360克			
检测程序	M325 2546 2415 2416			
电线插头	所有1.5 X 25CM			
内盒尺寸	12*9.5*6CM			
外箱尺寸	49.5*25.5*30.5CM			
输出电压	14.5±0.5V 50安培			
一箱只数	50			
铝壳尺寸	83*94*25.7MM			
重要说明	3黄线 1红线 1绿线			
产品编号	R2001A. 5. 1		 1. Battery (+) / Bateria (+) 2. Ignition Switch / Sensor 3. GND / Masa 4. Power Coil / Bobina de Carga 5. Power Coil / Bobina de Carga 6. Power Coil / Bobina de Carga	适用于: Honda SH 300 2007 2010 31600-KTW-901
产品单重	360克			
检测程序	M325			
电线插头	所有1.5 X 25CM			
内盒尺寸	12*9.5*6CM			
外箱尺寸	49.5*25.5*30.5CM			
输出电压	14.5±0.5V			
一箱只数	50			
铝壳尺寸	83*94*25.7MM			
重要说明	3黄线 1红线 1绿线1黑线是检测线			

产品资料1		实物主图	接口图	适用范围
产品编号	R2001A.6		 <p>1. Battery (+) / Bateria (+) 2. Battery (+) / Bateria (+) 3. GND / Masa 4. GND / Masa 5. Power Coil / Bobina de Carga 6. Power Coil / Bobina de Carga 7. Power Coil / Bobina de Carga</p>	适用于: Suzuki DL V-Strom 650 2007 2012 32800-41G00 Suzuki DL 650 2013 2017 32800-47H10 Suzuki GSF Bandit 1250 2007 2009 32800-18H00 Suzuki GSF SA 1250 2016 32800-41G10 Suzuki GSF Bandit 650 2007 2010 32800-18H00 Suzuki GSX R 1000 2005 2008 32800-21H00
产品单重	360克			
检测程序	M325			
电线插头	黄1.5 X 25CM			
内盒尺寸	12*9.5*6CM			
外箱尺寸	49.5*25.5*30.5CM			
输出电压	14.5±0.5V			
一箱只数	50			
铝壳尺寸	83*94*25.7MM			
重要说明	3黄线 2红线 2绿线			
产品编号	R2001A.7		 <p>1. Battery (+) / Bateria (+) 2. GND / Masa 3. Power Coil / Bobina de Carga 4. Power Coil / Bobina de Carga 5. Power Coil / Bobina de Carga</p>	适用于: Honda XLV Vara ro 1000 2003 2011 31600-MBT-D21 Reem lazo Shin ngen FH008AA
产品单重	400克			
检测程序	M325			
电线插头	所有1.5 X 45CM			
内盒尺寸	12*9.5*6CM			
外箱尺寸	49.5*25.5*30.5CM			
输出电压	14.5±0.5V			
一箱只数	50			
铝壳尺寸	83*94*25.7MM			
重要说明	88MM			
产品编号	R2001A.8		 <p>1. GND 2. Battery (+) 3. GND 4. Battery (+) 5. Power Coil 6. Power Coil 7. Power Coil</p>	2404 Honda CBR RR 929 2001 2003 31600-MCJ-641 Honda CBR RE 929 2001 2003 31600-MCJ-641 Reem lazo Shin ngen SH678C-13 2414 Honda CBR RR 600 2003 31600-MEE-003 Honda CBR RR 600 2004 2006 31600-MEE-872
产品单重	360克			
检测程序	M325 2404 2414			
电线插头	黄1.5 X 25CM			
内盒尺寸	12*9.5*6CM			
外箱尺寸	49.5*25.5*30.5CM			
输出电压	14.5±0.5V 35安培			
一箱只数	50			
铝壳尺寸	83*94*25.7MM			
重要说明	3黄线 2红线 2绿线			
产品编号	R2001A.9		 <p>1. GND 2. Battery (+) 3. Power Coil 4. Power Coil 5. Power Coil</p>	2546 Honda VT Shadow 750 2010 2018 31600-MFE-641 Honda VT Shadow 400 2009 2016 31600-MFE-641 Reem lazo Shin ngen SH678FF 2415 Honda NSS za EX 250 2005 2007 31600-KSV-J01 Honda NSS za ABS 250 2005 2007 31600-KSV-J01
产品单重	360克			
检测程序	M325 2546 2415 2416			
电线插头	所有1.5 X 25CM			
内盒尺寸	12*9.5*6CM			
外箱尺寸	49.5*25.5*30.5CM			
输出电压	14.5±0.5V M50安培			
一箱只数	50			
铝壳尺寸	83*94*25.7MM			
重要说明	88MM			

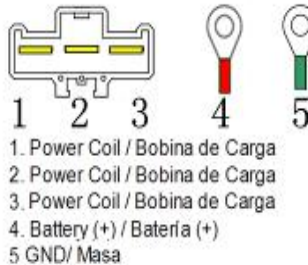

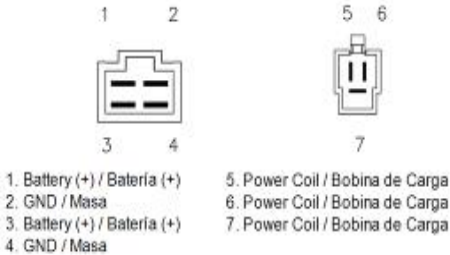



产品资料1		实物主图	接口图	适用范围
产品编号	R2001A.10		<p style="text-align: center;">黄线交流 红线正极 绿线负极</p>	适用于: Universal5cables12V50Asinsensor
产品单重	360克			
检测程序	M325			
电线插头	黄1.5 X 40CM			
内盒尺寸	12*9.5*6CM			
外箱尺寸	49.5*25.5*30.5CM			
输出电压	14.5±0.5V			
一箱只数	50			
铝壳尺寸	83*94*25.7MM			
重要说明	88MM			
产品编号	R2001A.11		 <p>1. Battery (+) / Bateria (+) 2. GND / Masa 3. Battery (+) / Bateria (+) 4. GND / Masa 5. Power Coil / Bobina de Carga 6. Power Coil / Bobina de Carga 7. Power Coil / Bobina de Carga</p>	适用于: STATOR®ULATORRECTIFIERFITSTRIMUM HDAYTONA6752006-2013MOFSETREGULATOR
产品单重	360克			
检测程序	M325			
电线插头	黄1.5 X 45CM			
内盒尺寸	12*9.5*6CM			
外箱尺寸	49.5*25.5*30.5CM			
输出电压	14.5±0.5V			
一箱只数	50			
铝壳尺寸	83*94*25.7MM			
重要说明	3插带钩 4插带钩			
产品编号	R2001A.12		 <p>1. Battery (+) / Bateria (+) 2. Battery (+) / Bateria (+) 3. GND / Masa 4. GND / Masa 5. Power Coil / Bobina de Carga 6. Power Coil / Bobina de Carga 7. Power Coil / Bobina de Carga</p>	Alication: Z031-0003N 32800-02H00 32800-15H0032800- 18H0032800-21H0032800-41F1032800- 41F1132800-47H0032800-47H10 SuzukiBandit12502007-2009 SuzukiB-KingGSX13002008-2009 SuzukiBoulevardC902005-2008 SuzukiGSX12502011 SuzukiGSX650F2008-2009 SuzukiGSXR6002006-2011 SuzukiGSXR7502006-2011
产品单重	360克			
检测程序	M325			
电线插头	黄1.5 X 25CM			
内盒尺寸	12*9.5*6CM			
外箱尺寸	49.5*25.5*30.5CM			
输出电压	14.5±0.5V			
一箱只数	50			
铝壳尺寸	83*94*25.7MM			
重要说明	88MM			
产品编号	R2001A.13		 <p>1. Battery(+)/ Bateria (+) 2. Battery(+)/ Bateria (+) 3. Battery(-)/ Bateria (-) 4. Battery(-)/ Bateria (-) 4. Power Coil / Generator 5. Power Coil / Generator 6. Power Coil / Generator</p>	2460 12V 35A Arilia RSV R Tuono 1000 2002 2005 A 8124267 Arilia RSV S /R 1000 1998 2003 A 8124267 Arilia SL Falco 1000 2000 2002 A 8124267
产品单重	360克			
检测程序	M325 2460			
电线插头	黄1.5 X 25CM			
内盒尺寸	12*9.5*6CM			
外箱尺寸	49.5*25.5*30.5CM			
输出电压	14.5±0.5V 35安培			
一箱只数	50			
铝壳尺寸	83*94*25.7MM			
重要说明	88MM			

产品资料1		实物主图	接口图	适用范围
产品编号	R2001A.14		 <p>1 Battery (+) 2 GND (-) 3 Battery (+) 4 GND (-) 5 POWER COIL 6 POWER COIL 7 POWER COIL</p>	Alication: SUZUKIGSXR600750 1980HondaGoldwing1100GL1100IInterstate 1987HondaGoldwing1200GL1200AAs enca
产品单重	360克			
检测程序	黄1.5 X M325			
电线插头	30红黑45CM			
内盒尺寸	12*9.5*6CM			
外箱尺寸	49.5*25.5*30.5CM			
输出电压	14.5±0.5V			
一箱只数	50			
铝壳尺寸	83*94*25.7MM			
重要说明	88MM			
产品编号	R2001A.15		 <p>1. Battery (+) / Bateria (+) 2. GND / Masa 3. Power Coil / Bobina de Carga 4. Power Coil / Bobina de Carga 5. Power Coil / Bobina de Carga</p>	Alication: -2000Trium hTT -2001Trium hAmerica -2001Trium hBonneville -2001Trium hT100
产品单重	360克			
检测程序	M325			
电线插头	黄1.5 X 35CM			
内盒尺寸	12*9.5*6CM			
外箱尺寸	49.5*25.5*30.5CM			
输出电压	14.5±0.5V			
一箱只数	50			
铝壳尺寸	83*94*25.7MM			
重要说明	88MM			
产品编号	R2001A.16		 <p>1. Power Coil / Bobina de Carga 2. Power Coil / Bobina de Carga 3. Power Coil / Bobina de Carga 4. Battery (+) / Bateria (+) 5. GND / Masa</p>	Alication: KTM690Enduro08-11/690SMC08-102112-0972KTM6909509901190
产品单重	360克			
检测程序	M325			
电线插头	所有1.5 X 35CM			
内盒尺寸	12*9.5*6CM			
外箱尺寸	49.5*25.5*30.5CM			
输出电压	14.5±0.5V			
一箱只数	50			
铝壳尺寸	83*94*25.7MM			
重要说明	88MM			
产品编号	R2001A.17		 <p>1. Battery (+) / Bateria (+) 2. GND / Masa 3. Battery (+) / Bateria (+) 4. GND / Masa 5. Power Coil / Bobina de Carga 6. Power Coil / Bobina de Carga 7. Power Coil / Bobina de Carga</p>	适用于: Ducati7481999 Ducati7482001-2002
产品单重	460克			
检测程序	M325			
电线插头	黄1.5 X 45CM			
内盒尺寸	12*9.5*6CM			
外箱尺寸	49.5*25.5*30.5CM			
输出电压	14.5±0.5V			
一箱只数	50			
铝壳尺寸	83*94*25.7MM			
重要说明	88MM			

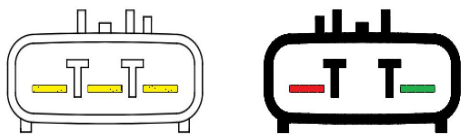

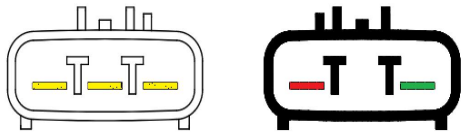

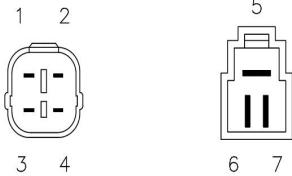

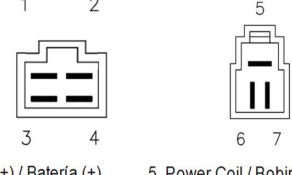
产品资料1		实物主图	接口图	适用范围
产品编号	R2001A.18		 <p>1. Battery (+) / Bateria (+) 2. GND / Masa 3. Battery (+) / Bateria (+) 4. GND / Masa 5. Power Coil / Bobina de Carga 6. Power Coil / Bobina de Carga 7. Power Coil / Bobina de Carga</p>	适用于: MOTOGUZZI V11 CAFES ORTBALLABIO 2003-2006 540.4.027.1A 540.4.019.1A T1300560 Trium hDaytona955i20022003200420052006Ducat i10982007-2008 Ducati11982009-2011 Ducati7492003-2007 Ducati848StreetFighter2012-2013 Ducati848Super
产品单重	460克			
检测程序	M325			
电线插头	黄1.5 X 45CM			
内盒尺寸	12*9.5*6CM			
外箱尺寸	49.5*25.5*30.5CM			
输出电压	14.5±0.5V			
一箱只数	50			
铝壳尺寸	83*94*25.7MM			
重要说明	88MM			
产品编号	R2001A.19		 <p>1. Battery (+) / Bateria (+) 2. GND / Masa 3. Battery (+) / Bateria (+) 4. GND / Masa 5. Power Coil / Bobina de Carga 6. Power Coil / Bobina de Carga 7. Power Coil / Bobina de Carga</p>	适用于: T1300823Trium hDaytona6752006-2012 Trium hDaytona675SE2011 Trium hDaytona675R2011-2012
产品单重	460克			
检测程序	M325			
电线插头	黄1.5 X 45CM			
内盒尺寸	12*9.5*6CM			
外箱尺寸	49.5*25.5*30.5CM			
输出电压	14.5±0.5V			
一箱只数	50			
铝壳尺寸	83*94*25.7MM			
重要说明				
产品编号	R2001A.20			适用于: Notes Year Make Mo l Submo l 2001 Victory V92C -- 2001 Victory V92C luxe 2000 Victory V92C -- 1999 Victory V92C -- 2001 Victory V92SC -- 2000 Victory V92SC -
产品单重				
检测程序	M325			
电线插头	所有1.5 X 45CM			
内盒尺寸	12*9.5*6CM			
外箱尺寸	49.5*25.5*30.5CM			
输出电压	14.5±0.5V			
一箱只数	50			
铝壳尺寸	83*94*25.7MM			
重要说明				
产品编号	R2001A.21			适用于: 2001 Victory V92C -- 2001 Victory V92C luxe 2000 Victory V92C -- 1999 Victory V92C -- 2001 Victory V92SC -- 2000 Victory V92SC --
产品单重				
检测程序	M325			
电线插头	所有1.5 X 45CM			
内盒尺寸	12*9.5*6CM			
外箱尺寸	49.5*25.5*30.5CM			
输出电压	14.5±0.5V			
一箱只数	50			
铝壳尺寸	83*94*25.7MM			
重要说明	所有1.5 X 45CM			



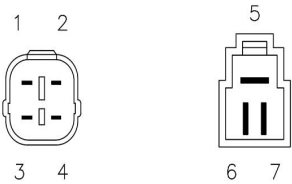

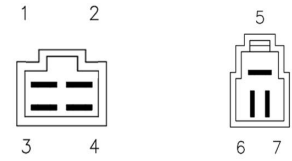
产品资料1		实物主图	接口图	适用范围
产品编号	R2001A. 22			适用于: 2112-0935 27-10560 Notes Year Make Mo l Submo l 2007 Victory Hammer -- 2007 Victory Hammer remium 2007 Victory Hammer S 2006 Victory Hammer -- 2006 Victory Hammer remium 2005 Victory Hammer -- 2007 Victory King in -- 2007 Victory King in remium
产品单重				
检测程序	M325			
电线插头	所有1.5 X 35CM			
内盒尺寸	12*9.5*6CM			
外箱尺寸	49.5*25.5*30.5CM			
输出电压	14.5±0.5V			
一箱只数	50			
铝壳尺寸	83*94*25.7MM			
重要说明				
产品编号	R2001A. 23			适用于: 10-564H 2016Polaris ACE -- 2016Polaris ACE 570 -- 2016Polaris ACE 570 S 2014Polaris RZR 4 900 LE E S 2015Polaris RZR 4 X 1000 E S 2014Polaris RZR 900 -- 2014Polaris RZR 900 LE E S 2016Polaris RZR X 1000 E S 2016Polaris RZR X 1000 High Lifter Edition E S
产品单重				
检测程序	M325			
电线插头	所有1.5 X 45CM			
内盒尺寸	12*9.5*6CM			
外箱尺寸	49.5*25.5*30.5CM			
输出电压	14.5±0.5V			
一箱只数	50			
铝壳尺寸	83*94*25.7MM			
重要说明				
产品编号	R2001A. 24		 1 2 3 4 5 1. Battery (+) / Bateria (+). Power Coil / Bobina de Carga 2. GND / Masa 4. Power Coil / Bobina de Carga 5. Power Coil / Bobina de Carga	适用于: 2112-093 Suzuki AN650 Burgman VZR1800 Boulevard
产品单重				
检测程序	M325			
电线插头	1.5X25CM			
内盒尺寸	12*9.5*6CM			
外箱尺寸	49.5*25.5*30.5CM			
输出电压	14.5±0.5V			
一箱只数	50			
铝壳尺寸	83*94*25.7MM			
重要说明				
产品编号	R2001A. 26		 1 2 3 4 5 1. Battery (+) / Bateria (+) 3. Power Coil / Bobina de Carga 2. GND / Masa 4. Power Coil / Bobina de Carga 5. Power Coil / Bobina de Carga	Suzuki AN Burgman 650 2006 2011 32800-10G30 Suzuki VZR Intru r 1800 2006 2012 32800-10G30
产品单重				
检测程序	M325 2597			
电线插头	所有1.5 X 25CM			
内盒尺寸	12*9.5*6CM			
外箱尺寸	49.5*25.5*30.5CM			
输出电压	14.5±0.5V 50安培			
一箱只数	50			
铝壳尺寸	83*94*25.7MM			
重要说明				

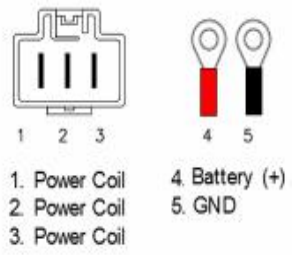

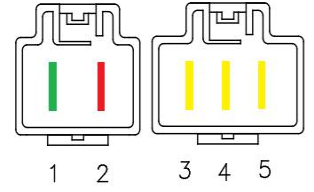

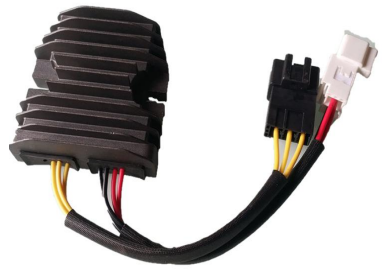
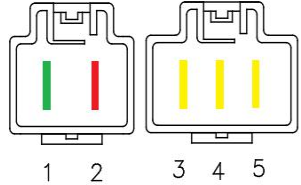
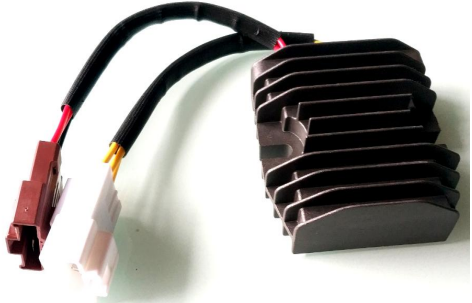
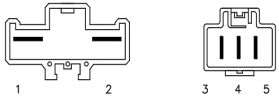
产品资料1		实物主图	接口图	适用范围
产品编号	R2001A. 27		 <p>1. Battery (+) / Bateria (+) 3. GND / Masa 4. Battery (+) / Bateria (+) 5. GND / Masa</p> <p>6. Power Coil / Bobina de Carga 7. Power Coil / Bobina de Carga 8. Power Coil / Bobina de Carga</p>	2003 Kawasaki Ninja ZX12R ZX1200B 2002 Kawasaki Ninja ZX12R ZX1200B 2001 Kawasaki Ninja ZX12R ZX1200A 2000 Kawasaki Ninja ZX12R ZX1200A 2003 Kawasaki Ninja ZX9R ZX900F 2002 Kawasaki Ninja ZX9R ZX900F 2001 Kawasaki Ninja ZX9R ZX900F 2000 Kawasaki Ninja ZX9R ZX900F
产品单重	360克			
检测程序	M325			
电线插头	黄1.5 X 30CM			
内盒尺寸	12*9.5*6CM			
外箱尺寸	49.5*25.5*30.5CM			
输出电压	14.5±0.5V			
一箱只数	50			
铝壳尺寸	83*94*25.7MM			
重要说明				
产品编号	R2001A. 28			Polaris 4011731 4012476 4012930 4013587 Polaris 600 Dragon EFI 2009 Polaris 600 H0 Cleanfire EFI 2007 Polaris 600 H0 IQ Cleanfire EFI 2007 Polaris 600 H0 IQ EFI 2007 Polaris 600 IQ Dragon EFI 2008 Polaris 600 IQ EFI 2008-2015 Polaris 600 IQ Shift EFI 2010-2012 Polaris 600 RMK 144 EFI 2010-2011 Polaris 600 RMK 155 EFI 2008/2010-
产品单重	475克			
检测程序	M325			
电线插头	黄线1.5其他1平方, 线长15 20CM			
内盒尺寸	12*9.5*6CM			
外箱尺寸	49.5*25.5*30.5CM			
输出电压	14.5±0.5V			
一箱只数	50			
铝壳尺寸				
重要说明	78MM			
产品编号	R2001A. 29			Victory Kingpin V92C V92TC Vegas Vegas 8-ball
产品单重	475克			
检测程序	M325			
电线插头	2平方线 25CM			
内盒尺寸	12*9.5*6CM			
外箱尺寸	49.5*25.5*30.5CM			
输出电压	14.5±0.5V			
一箱只数	50			
铝壳尺寸				
重要说明	78MM			
产品编号	R2001B. 1		 <p>1. Power Coil / Bobina de Carga 2. Power Coil / Bobina de Carga 3. Power Coil / Bobina de Carga</p> <p>4. Battery (+) / Bateria (+) 5. AC Output / Salida AC 6. GND / Masa</p>	Mosfet Application: 4012941 31600-H 0-A01 21066-0022 21066-0008 1D7- 81960-00-00 27D-81960-00-00 5JW- 81960-00-00 710000870 710001103 710001191 278002021 T1300470 540.4.030.1A 12317718422 1D7-81960- 01-00 515177325 710000261 Mosfet Voltage Regulator Rectifier Kawasaki Ninja 2005-2011 ZX 10 R / ZX 14 R (Fits: More than one vehicle) Can-am Commander 1000 2011-2014
产品单重	350克			
检测程序	M325			
电线插头	3针+3针			
内盒尺寸	12*9.5*6CM			
外箱尺寸	49.5*25.5*30.5CM			
输出电压	14.5±0.5V			
一箱只数	50			
铝壳尺寸	83*94*25.7MM			
重要说明	6针 5号针是接AC			

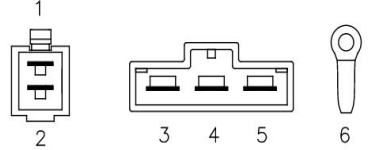
产品资料1		实物主图	接口图	适用范围
产品编号	R2001B. 1-5Z		 <p>1 2 3 4 5</p> <p>1. Power Coil 2. Power Coil 3. Power Coil 4. Battery (+) 5. GND</p>	Mosfet Application: 4012941 31600-H 0-A01 21066-0022 21066-0008 1D7- 81960-00-00 27D-81960-00-00 5JW- 81960-00-00 710000870 710001103 710001191 278002021 T1300470 540.4.030.1A 12317718422 1D7-81960- 01-00 515177325 710000261 Mosfet Voltage Regulator Rectifier Kawasaki Ninja 2005-2011 ZX 10 R / ZX 14 R (Fits: More than one vehicle) Can-am Commander 1000 2011-2014
产品单重	350克			
检测程序	M325			
电线插头	3针+2针			
内盒尺寸	12*9.5*6CM			
外箱尺寸	49.5*25.5*30.5CM			
输出电压	14.5±0.5V			
一箱只数	50			
铝壳尺寸	83*94*25.7MM			
重要说明	五针			
产品编号	R2001B. 1+D		 <p>1 2 3 4 5</p> <p>1. Power Coil 2. Power Coil 3. Power Coil 4. Battery (+) 5. GND</p>	Mosfet Application: 4012941 31600-H 0-A01 21066-0022 21066-0008 1D7- 81960-00-00 27D-81960-00-00 5JW- 81960-00-00 710000870 710001103 710001191 278002021 T1300470 540.4.030.1A 12317718422 1D7-81960- 01-00 515177325 710000261 Mosfet Voltage Regulator Rectifier Kawasaki Ninja 2005-2011 ZX 10 R / ZX 14 R (Fits: More than one vehicle) Can-am Commander 1000 2011-2014
产品单重	350克			
检测程序	M325			
电线插头				
内盒尺寸	12*9.5*6CM			
外箱尺寸	49.5*25.5*30.5CM			
输出电压	14.5±0.5V			
一箱只数	50			
铝壳尺寸	83*94*25.7MM			
重要说明	五针 配对插			
产品编号	R2001B. 2		 <p>1 2 3 4 5 6 7</p> <p>1. Battery (+) / Bateria (+) 2. Battery (+) / Bateria (+) 3. GND / Masa 4. GND / Masa 5. Power Coil / Bobina de Carga 6. Power Coil / Bobina de Carga 7. Power Coil / Bobina de Carga</p>	Mosfet Suzuki GSXR600 / GSXR750 / GSXR 1000 2006-2015
产品单重	360克			
检测程序	M325			
电线插头	黄1.5 X 30CM			
内盒尺寸	12*9.5*6CM			
外箱尺寸	49.5*25.5*30.5CM			
输出电压	14.5±0.5V			
一箱只数	50			
铝壳尺寸	83*94*25.7MM			
重要说明	3插不带钩 配对插			
产品编号	R2001B. 3		 <p>1 2 3 4 5 6 7</p> <p>1. Battery (+) / Bateria (+) 2. GND / Masa 3. Battery (+) / Bateria (+) 4. GND / Masa 5. Power Coil / Bobina de Carga 6. Power Coil / Bobina de Carga 7. Power Coil / Bobina de Carga</p>	Triumph Sprint ST 1050 2005-2010 T1300560 Triumph Sprint ST 1050 2005 2006 2007 2008 2009 2010 Triumph Daytona 600 2004-2005 Triumph Daytona 650 2004-2005 Triumph Daytona 955i 2002-2006 Triumph Speed Four 600 2003-2005 Triumph Speed Triple 955 2002- 2004 Triumph Speed Triple 1050 2005-
产品单重	360克			
检测程序	M325			
电线插头	黄1.5 X 30CM			
内盒尺寸	12*9.5*6CM			
外箱尺寸	49.5*25.5*30.5CM			
输出电压	14.5±0.5V			
一箱只数	50			
铝壳尺寸	83*94*25.7MM			
重要说明	配对插 插头都不带钩			

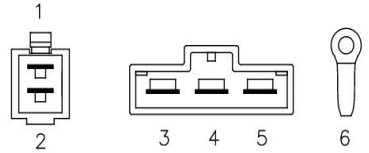



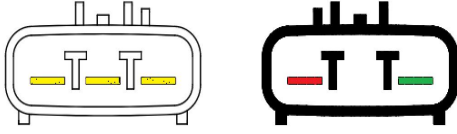

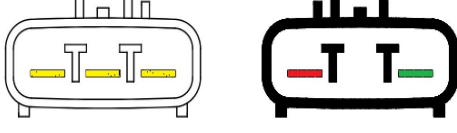
产品资料1		实物主图	接口图	适用范围
产品编号	R2001B.4		 <p>1 2 3 4 5</p> <p>1. Power Coil 4. Battery (+) 2. Power Coil 5. GND 3. Power Coil</p>	31600-MBG-306 31600-MCF-D30 31600-MBG-D01 31600-MCW-D01 31600-MCW-D61 31600-MCW-D60 31600-MBG-D00 Honda RVT 1000 RC 51 -- 2002-2006 Honda VFR 800 Interceptor -- 2000-2009
产品单重	360克			
检测程序	M325			
电线插头	黄1.5 X 30CM			
内盒尺寸	12*9.5*6CM			
重要说明	白色6插带钩 配对插 安装孔铰	R2001B.4	R2001B.4	
产品编号	R2001B.5	 <p>3和4插带钩 配对插 安装孔铰</p>	 <p>1 2 5 6</p> <p>3 4 7</p> <p>1. Battery (+) / Bateria (+) 5. Power Coil / Bobina de Carga 2. GND / Masa 6. Power Coil / Bobina de Carga 3. Battery (+) / Bateria (+) 7. Power Coil / Bobina de Carga 4. GND / Masa</p>	TRIUM H Daytona 675R 675cc 2012 RM30508H
产品单重	360克			
检测程序	M325			
电线插头	黄1.5 X 30CM 3黄2红2黑			
内盒尺寸	12*9.5*6CM			
重要说明	3和4 插带钩 配对插 安装孔铰	R2001B.5	R2001B.5	
产品编号	R2001C.1	 <p>5针</p>	 <p>1 2 3 4 5</p> <p>1. Power Coil 4. Battery (+) 2. Power Coil 5. GND 3. Power Coil</p>	Mosfet Yamaha Rai r / YZF R1 2002-2014 Yamaha FJR FJR1300 1300 2003 2005 5JW-81960-00 Yamaha FZ8 Fazer 800 2009 2011 1D7-81960-00 Yamaha FZ8 Fazer 800 2009 2011 1D7-81960-01 Yamaha FZ8 N 800 2009 2011 1D7-81960-01 Yamaha FZ8 N 800 2009 2011 1D7-81960-00
产品单重	360克			
检测程序	M325			
电线插头	40CM			
内盒尺寸	12*9.5*6CM			
重要说明		R2001C.1	R2001C.1	
产品编号	R2001C.2		 <p>1 2 3 4 5</p> <p>1. Power Coil 4. Battery (+) 2. Power Coil 5. GND 3. Power Coil</p>	Mosfet Honda VFR 800 / RVT1000R RC51 2000-2007 2008 2009 31600-MBG-306 31600-MBG-D00 31600-MBG-D01 31600-MCF-D30 31600-MCW-D01 31600-MCW-D60 31600-MCW-D61
产品单重	360克			
检测程序	M325			
电线插头	黄1.5 X 30CM 3黄2红2黑			
内盒尺寸	12*9.5*6CM			
重要说明		R2001C.2	R2001C.2	





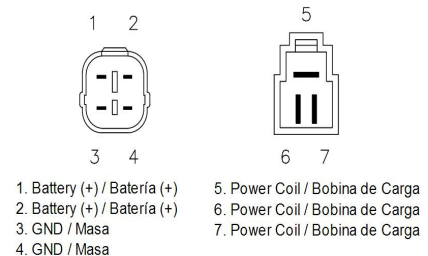

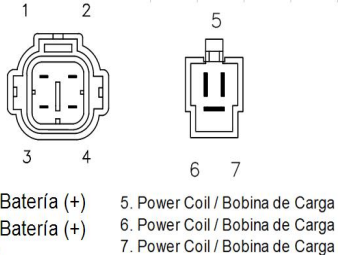
产品资料1		实物主图	接口图	适用范围
产品编号	R2001C.3		 <p>1. Battery (+) / Bateria (+) 2. Battery (+) / Bateria (+) 3. GND / Masa 4. GND / Masa 5. Power Coil / Bobina de Carga 6. Power Coil / Bobina de Carga 7. Power Coil / Bobina de Carga</p>	Suzuki GSXR 750 -- 2006-2009, 2011-2017 Suzuki GSXR 600 -- 2006-2009, 2011-2017 Suzuki GSXR 1000 -- 2007-2009, 2012-2016 Suzuki Boulevard C50 VL800 -- 2005-2007, 2013-2015 Suzuki Boulevard C50T VL800T -- 2014-2015 Suzuki SV 650 -- 2017
产品单重	360克			
检测程序	M325			
电线插头	黄1.5 X 30CM			
内盒尺寸	12*9.5*6CM			
外箱尺寸	49.5*25.5*30.5CM			
输出电压	14.5±0.5V			
一箱只数	50			
铝壳尺寸	83*94*25.7MM			
重要说明	3插不带钩 配对插			
产品编号	R2001C.4		 <p>1. Battery (+) / Bateria (+) 2. GND / Masa 3. Battery (+) / Bateria (+) 4. GND / Masa 5. Power Coil / Bobina de Carga 6. Power Coil / Bobina de Carga 7. Power Coil / Bobina de Carga</p>	MOSFE TRIUM H DAYTONA 675 R 2006-2012 T1300823
产品单重	360克			
检测程序	M325			
电线插头	黄1.5 X 30CM			
内盒尺寸	12*9.5*6CM			
外箱尺寸	49.5*25.5*30.5CM			
输出电压	14.5±0.5V			
一箱只数	50			
铝壳尺寸	83*94*25.7MM			
重要说明	3和4插不带钩 配对插			
产品编号	R2001C.5		 <p>1. Power Coil 2. Power Coil 3. Power Coil 4. Battery (+) 5. GND</p>	MOSFET Honda CBR 929 RR RMSTATOR HONDA VTX 1300 C (2004-2009) HONDA VTX 1300 R (2004-2009) HONDA VTX 1300 T (2008-2009) HONDA VTX 1300 S (2003-2007) HONDA CBR 600 RR (2004-2006) HONDA CBR 900 RR (2000-2001) HONDA CBR 929 RR (2000-2001) HONDA CB 900 F (2002-2003)
产品单重	420			
检测程序	M325			
电线插头	所有1.5 黄线25 红黑线50CM			
内盒尺寸	12*9.5*6CM			
外箱尺寸	49.5*25.5*30.5CM			
输出电压	14.5±0.5V			
一箱只数	50			
铝壳尺寸	83*94*25.7MM			
重要说明	配对插			
产品编号	R2001C.6		 <p>1. GND 2. Battery (+) 3. Power Coil 4. Power Coil 5. Power Coil</p>	MOSFET Honda za NSS250 NSS 250 X / EX 2005-2011
产品单重	360克			
检测程序	M325			
电线插头	黄1.5 X 30CM			
内盒尺寸	12*9.5*6CM			
外箱尺寸	49.5*25.5*30.5CM			
输出电压	14.5±0.5V			
一箱只数	50			
铝壳尺寸	83*94*25.7MM			
重要说明	配对插			

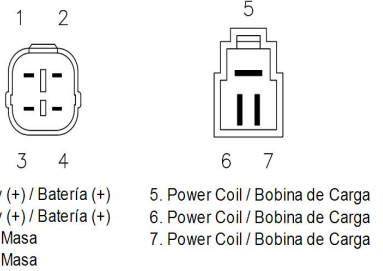
产品资料1		实物主图	接口图	适用范围
产品编号	R2001C.7		 <p>1. GND 2. Battery (+) 3. Power Coil 4. Power Coil 5. Power Coil</p>	MOSFET Motorcycle 2013 Honda VT 1300 RMSTATOR
产品单重	360克			
检测程序	M325			
电线插头	黄1.5 X 30CM			
内盒尺寸	12*9.5*6CM			
外箱尺寸	49.5*25.5*30.5CM			
输出电压	14.5±0.5V			
一箱只数	50			
铝壳尺寸	83*94*25.7MM			
重要说明	配对插			
产品编号	R2001C.8		 <p>1. GND/ Masa 2. Battery (+) / Bateria (+) 3. Power Coil / Bobina de Carga 4. Power Coil / Bobina de Carga 5. Power Coil / Bobina de Carga</p>	2413 Honda XL Vara ro 1000 2003 2011 31600-MBT-D21 Honda XL Vara ro ABS 1000 2004 2011 31600-MBT-D51 Reem lazo Shin ngen FH008AA
产品单重	360克			
检测程序	M325 2413			
电线插头	黄1.5 X 30CM			
内盒尺寸	12*9.5*6CM			
外箱尺寸	49.5*25.5*30.5CM			
输出电压	14.5±0.5V M50安培			
一箱只数	50			
铝壳尺寸	83*94*25.7MM			
重要说明	配对插			
产品编号	R2001C.9		 <p>1. Battery (+) / Bateria (+) 2. Battery (+) / Bateria (+) 3. Power Coil / Bobina de Carga 4. Power Coil / Bobina de Carga 5. Power Coil / Bobina de Carga 6. GND / Masa</p>	2577 KTM Duke 125 2011 2016 90111034000 KTM Duke 200 2012 2019 90111034000 KTM Duke 250 2015 2016 90111034000 KTM Duke 390 2013 2017 90111034000 2579 KTM RC 390 2014 2019 90511034000 KTM RC 250 2015 2017 90511034000 KTM RC 125 2014 2019 90511034000 KTM RC 200 2014 2019 90511034000
产品单重	360克			
检测程序	M325 2577 2579			
电线插头	黄1.5 X 30CM			
内盒尺寸	12*9.5*6CM			
外箱尺寸	49.5*25.5*30.5CM			
输出电压	14.5±0.5V MOSFET 50安培			
一箱只数	50			
铝壳尺寸	83*94*25.7MM			
重要说明				
产品编号	R2001C.10		 <p>1. Battery (+) / Bateria (+) 2. Battery (+) / Bateria (+) 3. Power Coil / Bobina de Carga 4. Power Coil / Bobina de Carga 5. Power Coil / Bobina de Carga 6. GND / Masa</p>	2578 KTM Duke 125 2017 2019 93011034000 KTM Duke 250 2017 2019 93011034000 KTM Duke 390 2017 2019 93011034000
产品单重	360克			
检测程序	M325 2578			
电线插头	黄1.5 X 黄线60 红黑线30CM			
内盒尺寸	12*9.5*6CM			
外箱尺寸	49.5*25.5*30.5CM			
输出电压	14.5±0.5V MOSFET 50安培			
一箱只数	50			
铝壳尺寸	83*94*25.7MM			
重要说明				

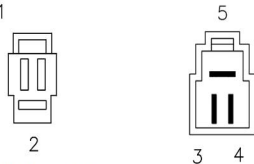

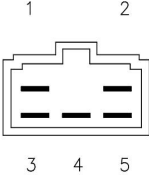

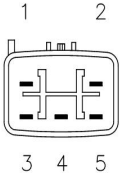

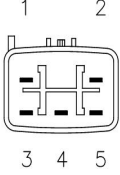
产品资料1		实物主图	接口图	适用范围
产品编号	R2001D.1		 <p>1 2 3 4 5</p> <p>1. Power Coil 2. Power Coil 3. Power Coil 4. Battery (+) 5. GND</p>	Honda MUV 2A 700 2009 2013 31600-H 5-601 Honda TRX FE/FM/TE/TM 420 2007 2013 31600-H 5-601 Honda TRX FA 420 2009 2014 31600-H 5-601 Honda TRX F A/F E/F M 420 2009 2013 31600-H 5-601 Reem lazo Shin ngen SH753AA
产品单重	450			
检测程序	M325 2448			
电线插头	3针+2针			
内盒尺寸	100*85*30MM			
外箱尺寸	49.5*25.5*30.5CM			
输出电压	14.5±0.5V 35安培			
一箱只数	50			
铝壳尺寸	80MM			
重要说明	五针			
产品编号	R2001D.1-D		 <p>1 2 3 4 5</p> <p>1. Power Coil 2. Power Coil 3. Power Coil 4. Battery (+) 5. GND</p>	Honda MUV 2A 700 2009 2013 31600-H 5-601 Honda TRX FE/FM/TE/TM 420 2007 2013 31600-H 5-601 Honda TRX FA 420 2009 2014 31600-H 5-601 Honda TRX F A/F E/F M 420 2009 2013 31600-H 5-601
产品单重				
检测程序	M325			
电线插头	3针+2针			
内盒尺寸	100*85*30MM			
外箱尺寸	49.5*25.5*30.5CM			
输出电压	14.5±0.5V			
一箱只数	50			
铝壳尺寸	80MM			
重要说明	五针 配对插			
产品编号	R2001E.1		 <p>1 2 3 4 5</p> <p>1. Power Coil 2. Power Coil 3. Power Coil 4. Battery (+) 5. GND</p>	CAN-AM ATV Outlan r 800R EFI XT- D S FH019AA 710001191 2015 Can-Am Comman r 800 4X4 2015 Can-Am Comman r 800 4x4 D S 2015 Can-Am Comman r 800 4x4 XT 2015 Can-Am Comman r 800 4x4 XT Rear 0 en Differential 2014 Can-Am Comman r 800 4X4 2014 Can-Am Comman r 800 4x4 D S 2014 Can-Am Comman r 800 4x4 XT 2014 Can-Am Comman r 800 4x4 XT Rear
产品单重	净重554克 盒重620克			
检测程序	M6010			
电线插头	3针+2针			
内盒尺寸	100*85*30MM			
外箱尺寸	49.5*25.5*30.5CM			
输出电压	14.5±0.5V			
一箱只数	50			
铝壳尺寸				
重要说明	五针			
产品编号	R2001E.1-D		 <p>1 2 3 4 5</p> <p>1. Power Coil 2. Power Coil 3. Power Coil 4. Battery (+) 5. GND</p>	Can-Am ATV / UTV / Motorcycle OEM Re 1.# 710001191
产品单重	3针+2针			
检测程序	M6010			
电线插头				
内盒尺寸	100*85*30MM			
外箱尺寸	49.5*25.5*30.5CM			
输出电压	14.5±0.5V			
一箱只数	50			
铝壳尺寸				
重要说明	五针 配对插			



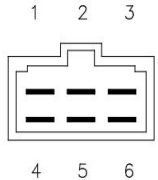

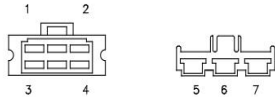

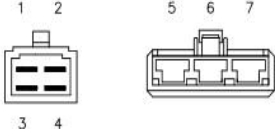
产品资料1		实物主图	接口图	适用范围
产品编号	R2001F.1		 <p>1-2-3 bob. de carga / power coil 4 batería (+) / battery (+) 5 N/C 6 batería (-) / battery (-)</p> <p>共六针，5号针不接</p>	Voltage Regulator RectifierPolaris RZR 1000 X 900 ATV UTV OEM 4014856
产品单重	503克净重			
检测程序	M6010			
电线插头	3针+3针 5号针不接线			
内盒尺寸	100*85*30MM			
外箱尺寸	49.5*25.5*30.5CM			
输出电压	14.5±0.5V			
一箱只数	50			
铝壳尺寸				
重要说明	共6针，5号针不接			
产品编号	R2001F.1+D		 <p>1-2-3 bob. de carga / power coil 4 batería (+) / battery (+) 5 N/C 6 batería (-) / battery (-)</p>	RÉGULATEUR RECTIFIEUR MOSFETPolaris SCRAMBLER 850 1000 S ORTSMAN 570 850 1000 ACE 500 570 1000 OEM 4014856 4016868 SH847AA S annungsregler Längsregler inkl. Ada terstecker RZR 1000 XP 900 2013-2018 65A
产品单重				
检测程序	M6010			
电线插头	3针+3针 5号针不接线			
内盒尺寸	100*85*30MM			
外箱尺寸	49.5*25.5*30.5CM			
输出电压	14.5±0.5V			
一箱只数	50			
铝壳尺寸				
重要说明	共6针，5号针不接，配对插			
产品编号	R2001F.2		 <p>1-2-3 bob. de carga / power coil 4 batería (+) / battery (+) 5 N/C 6 batería (-) / battery (-)</p>	2535 Polaris Scrambler X 1000 2014 2016 4012678 Polaris Scrambler X 850 2014 4012678 Polaris Scrambler HO E S 850 2013 4012678 Polaris Scrambler 850 2015 2016 4012678 Polaris S ortzman HL / MD 1000 2015 2016 4012678
产品单重				
检测程序	M6010 2535 2537 2549			
电线插头	3平方红黑线80 黄线140CM			
内盒尺寸	100*85*30MM			
外箱尺寸	49.5*25.5*30.5CM			
输出电压	14.5±0.5V 50安培			
一箱只数	50			
铝壳尺寸				
重要说明	共6针，5号针不接，配对插链电线			
产品编号	R2001F.3		 <p>1-2-3 bob. de carga / power coil 4 batería (+) / battery (+) 5 N/C 6 batería (-) / battery (-)</p>	2013-2018Polaris RZR 900/1000 STAGE 2 Ultimate Mosfet Voltage Regulator ermanace U gra Kit OEM Re l.# 4013978 4015816
产品单重				
检测程序	M6010			
电线插头	3X30CM 6针 5号针不接线			
内盒尺寸	100*85*30MM			
外箱尺寸	49.5*25.5*30.5CM			
输出电压	14.5±0.5V			
一箱只数	50			
铝壳尺寸				
重要说明	共6针，5号针不接，配对插链电线			

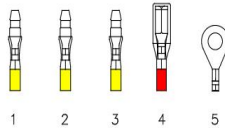
产品资料1		实物主图	接口图	适用范围
产品编号	R2001G.1			BMW R1200 GS 2013 to 2017 FH020AA FH010AA Yamaha FZ07 FZ09 FZ1 YZF R1 FJ09 FJR1300 FH020AA Honda CBR650F 600RR Polaris 4012941 庞巴迪摩托艇 Can-Am 710001103 SH775AA
产品单重	净重327克			
检测程序	M325			
电线插头	3针+2针			
内盒尺寸	12*9.5*6CM			
外箱尺寸	49.5*25.5*30.5CM			
输出电压	14.5±0.5V			
一箱只数	50			
铝壳尺寸				
重要说明	五针			
产品编号	R2002.0			Suzuki DL V-Strom 650 2007 2012 32800-41G00 Suzuki DL 650 2013 2017 32800-47H10 Suzuki GSF Bandit 1250 2007 2009 32800-18H00 Suzuki GSF SA 1250 2016 32800-41G10 Suzuki GSF Bandit 650 2007 2010 32800-18H00 Suzuki GSX R 1000 2005 2008 32800-21H00 Suzuki GSX R 600 2006 2007 32800-
产品单重	240克			
检测程序	M325			
电线插头	黑1.5 X 25CM			
内盒尺寸	12*9.5*6CM			
外箱尺寸	49.5*25.5*30.5CM			
输出电压	14.5±0.5V			
一箱只数	50			
铝壳尺寸				
重要说明				
产品编号	R2002.0A			Suzuki GSX650 GSX650 F 2008-2014 Suzuki SV1000 2003-2007 Suzuki SV650 2003-2012 Suzuki GSXR600 2006-2011 Suzuki GSXR750 2006-2011 GSR750 Suzuki GSXR1000 2005-2012 Suzuki SFV650 2009-2011 Suzuki GSF1250 2007-2010 Suzuki DL650 (V-Strom) 2004-2012 Suzuki VL1500 (Intruder LC) 2005-2009 Suzuki VL800 (Boulevard C50) 2006-
产品单重	总重 275克			
检测程序	M325			
电线插头	黑1.5 X 25CM			
内盒尺寸	12*9.5*6CM			
外箱尺寸	49.5*25.5*30.5CM			
输出电压	14.5±0.5V			
一箱只数	50			
铝壳尺寸				
重要说明				
产品编号	R2002.1			YHC016 Suzuki DL V-Strom 650 2007 2012 32800-41G00 Suzuki DL 650 2013 2017 32800-47H10 Suzuki GSF Bandit 1250 2007 2009 32800-18H00 Suzuki GSF SA 1250 2016 32800-41G10 Suzuki GSF Bandit 650 2007 2010 32800-18H00 Suzuki GSX R 1000 2005 2008 32800-21H00
产品单重	240克			
检测程序	M325			
电线插头	黑1.5 X 25CM			
内盒尺寸	12*9.5*6CM			
外箱尺寸	49.5*25.5*30.5CM			
输出电压	14.5±0.5V			
一箱只数	50			
铝壳尺寸				
重要说明				

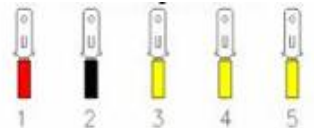

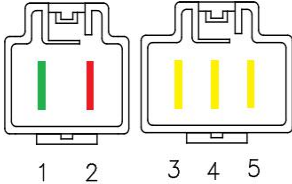
产品资料1		实物主图	接口图	适用范围
产品编号	R2002. 1. 1		 <p>1. Battery (+) / Bateria (+) 2. GND / Masa</p> <p>3. Power Coil / Bobina de Carga 4. Power Coil / Bobina de Carga 5. Power Coil / Bobina de Carga</p>	2384 Cagiva Ra tor 650 2001 2005 Reem lazo ietcard 1184 Suzuki DR SE 350 1997 1999 32800-14D11 Suzuki DR SE 250 1990 1995 32800-14D10 Suzuki DR SE 350 1990 1996 32800-14D10 Suzuki LS Savage LS650 K1 K2 K3 650 1996 2004 32800-24B01
产品单重	240克			
检测程序	325 2384 2500			
电线插头	30CM			
内盒尺寸	12*9. 5*6CM			
外箱尺寸	49. 5*25. 5*30. 5CM			
输出电压	14. 5±0. 5V 35安培			
一箱只数	50			
铝壳尺寸				
重要说明				
产品编号	R2002. 2		 <p>1. Battery (+) / Bateria (+) 2. GND / Masa</p> <p>3. Power Coil / Bobina de Carga 4. Power Coil / Bobina de Carga 5. Power Coil / Bobina de Carga</p>	2542 Gas GasWildH 450 2003 2007 MFS400134009 SuzukiANBurgman400 1999 200232800-14F01 SuzukiANBurgman250 1998 200232800-14F00 SuzukiDRS800 1990 199532800-34A01 SuzukiDRRSE650 1991 199632800-34A01 SuzukiDRS750 1988 198932800-34A00 SuzukiSV650 1999 200232800-33C10
产品单重	240克			
检测程序	M325 2543			
电线插头	黑1. 5 X 25CM			
内盒尺寸	12*9. 5*6CM			
外箱尺寸	49. 5*25. 5*30. 5CM			
输出电压	14. 5±0. 5V 35安培			
一箱只数	50			
铝壳尺寸				
重要说明	正极是黑红线 负极是黑白线			
产品编号	R2002. 3		 <p>1. Battery (+) / Bateria (+) 2. GND / Masa</p> <p>3. Power Coil / Bobina de Carga 4. Power Coil / Bobina de Carga 5. Power Coil / Bobina de Carga</p>	2375 HondaTRXA / AC400 1999 200031600-HM8-003 HondaTRXEX / TE / TM250 1997 2005 31600-HM8-013 HondaTRXEX400 1999 200431600-HM8-013 HondaTRXA / AC250 1997 200031600-HM8-003 HondaTRXTE250 2005 200931600-HM8-B00 HondaTRXTE250 2011 201431600-HM8-B00 HondaTRXTE250 2016 201731600-HM8-B00
产品单重	230克			
检测程序	M325 2375 2376 2364 2365 2539 236			
电线插头	6针插头			
内盒尺寸	12*9. 5*6CM			
外箱尺寸	49. 5*25. 5*30. 5CM			
输出电压	14. 5±0. 5V 35安培			
一箱只数	50			
铝壳尺寸				
重要说明				
产品编号	R2002. 3A		 <p>1. Battery (+) / Bateria (+) 2. GND / Masa</p> <p>3. Power Coil / Bobina de Carga 4. Power Coil / Bobina de Carga 5. Power Coil / Bobina de Carga</p>	Yamaha ATV 5GT-81960-00-00 Bear Tracker YFM250 230cc 2001-04 Big Bear 250 YFM25B 230cc 2006-09 Big Bear 400 YFM40 386cc 2002-12 Bruin 250 YFM250BT 230cc 2005-06 Bruin 350 YFM35 348cc 2004-06 Grizzly 125 YFM125 124cc 2004-13 Grizzly 350 YFM35 348cc 2007-13 Grizzly 400 YFM4FG 401cc 2007-08 Grizzly 450 YFM45FG 421cc 2007-13 Grizzly 600 YFM600 595cc 1999-01
产品单重	230克			
检测程序	M325			
电线插头	6针插头			
内盒尺寸	12*9. 5*6CM			
外箱尺寸	49. 5*25. 5*30. 5CM			
输出电压	14. 5±0. 5V			
一箱只数	50			
铝壳尺寸				
重要说明				

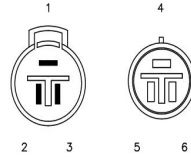
产品资料1		实物主图	接口图	适用范围
产品编号	R2002.3.1		 <ol style="list-style-type: none"> 1. Battery (+) / Bateria (+) 2. Ignition Switch / Sensor 3. GND / Masa 4. Power Coil / Bobina de Carga 5. Charge Lamp / Lámpara Piloto 6. Power Coil / Bobina de Carga 	OEM: M97348 AM70121 AM126304 / 21066-2056 / 21066-2070 JJOHN DEERE 130 15A M70121 JOHN DEERE 160 15A M70121 JOHN DEERE 165 15A M70121 JOHN DEERE 170 15A M70121 JOHN DEERE 172 15A M70121 JOHN DEERE 175 15A M70121 JOHN DEERE 176 15A M70121 JOHN DEERE 180 15A M70121 JOHN DEERE 185 15A M70121
产品单重	230克			
检测程序	QF2101新			
电线插头	6针插头			
内盒尺寸	12*9.5*6CM			
外箱尺寸	49.5*25.5*30.5CM			
输出电压	14.5±0.5V			
一箱只数	50			
铝壳尺寸				
重要说明	接上交流 指示灯电压12V->0V			
产品编号	R2002.3.2		 <ol style="list-style-type: none"> 1. Battery (+) / Bateria (+) 2. Ignition Switch / Sensor 3. GND / Masa 4. Power Coil / Bobina de Carga 5. Power Coil / Bobina de Carga 	Honda H 5013 A2/AC2 A4/AC4 31600-890-951 / SH547-12 Honda HT 3810 Lawn Tractor 31600-890-951 / SH547-12 Honda HT 3813 Lawn Tractor 31600-890-951 / SH547-12 Honda HT 4213 Lawn Tractor 31600-890-951 / SH547-12 Honda RT 5000 31600-890-951 / SH547-12 31600-ZE2-861
产品单重	230克 净重213克			
检测程序	215 2320			
电线插头				
内盒尺寸	12*9.5*6CM			
外箱尺寸	49.5*25.5*30.5CM			
输出电压	14.5±0.5V 20			
一箱只数	50			
铝壳尺寸				
重要说明				
产品编号	R2002.3.3		 <ol style="list-style-type: none"> 1. Battery (+) 2. GND 3. Power Coil 4. Power Coil 5. Power Coil 	2371 25A Hyosung GA F Cruise 125 2005 2006 32800-H01-413 Hyosung GF 125 2005 Hyosung GT Comet R 125 2004 2011 32800-H01-413 Hyosung GT Comet 125 2004 2008 Hyosung GT R 250 Hyosung GT 250 Hyosung GV Aquila 125 2005 2008 Hyosung GV 250
产品单重	230克			
检测程序	M325 2372 2371 2351 2353			
电线插头	5针插头			
内盒尺寸	12*9.5*6CM			
外箱尺寸	49.5*25.5*30.5CM			
输出电压	14.5±0.5V 12安培-25安培			
一箱只数	50			
铝壳尺寸				
重要说明				
产品编号	R2002.3.4		 <ol style="list-style-type: none"> 1. Battery (+) / Bateria (+) 2. Ignition Switch / Sensor 3. GND / Masa 4. Power Coil / Bobina de Carga 5. Power Coil / Bobina de Carga 6. Power Coil / Bobina de Carga 	Kawasaki KEF Lakota 300 1995 2000 21066-1089 Kawasaki KEF Lakota S ort 300 2001 2003 21066-1089 Kawasaki KFX 300 2001 2004 21066-1089 Kawasaki KLF Bayou 300 1988 1991 21066-1101 Kawasaki KLF Bayou 4x4 300 1989 2002 21066-1089 Kawasaki KLF Bayou 300 1988 1991
产品单重	230克			
检测程序	M325 2443			
电线插头	6针插头			
内盒尺寸	12*9.5*6CM			
外箱尺寸	49.5*25.5*30.5CM			
输出电压	14.5±0.5V 25安培			
一箱只数	50			
铝壳尺寸				
重要说明				

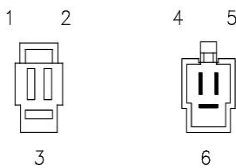
产品资料1		实物主图	接口图	适用范围
产品编号	R2002.3.5		 <ol style="list-style-type: none"> 1. Lights (+) / Luces (+) 2. Battery (+) / Bateria (+) 3. GND / Masa 4. Power Coil / Bobina de Carga 5. Power Coil / Bobina de Carga 6. Power Coil / Bobina de Carga 	2438 Corven Energy 110 Gilera G1 250 2013 Reem lazo ietcard 1419 Universal Luces Encendidas
产品单重	230克			
检测程序	M325 2438 CC+LUCES			
电线插头	6针插头			
内盒尺寸	12*9.5*6CM			
外箱尺寸	49.5*25.5*30.5CM			
输出电压	14.5±0.5V 12安培			
一箱只数	50			
铝壳尺寸				
重要说明				
产品编号	R2002.4		 <ol style="list-style-type: none"> 1. Battery (+) / Bateria (+) 2. GND / Masa 3. Battery (+) / Bateria (+) 4. GND / Masa 5. Power Coil / Bobina de Carga 6. Power Coil / Bobina de Carga 7. Power Coil / Bobina de Carga 	2460 12V 35A Aprilia RSV R Tuono 1000 2002 2005 A 8124267 Aprilia RSV S /R 1000 1998 2003 A 8124267 Aprilia SL Falco 1000 2000 2002 A 8124267
产品单重	240克			
检测程序	M325 2460			
电线插头	黄1.5 X 20CM			
内盒尺寸	12*9.5*6CM			
外箱尺寸	49.5*25.5*30.5CM			
输出电压	14.5±0.5V 35安培			
一箱只数	50			
铝壳尺寸				
重要说明				
产品编号	R2002.4.1		 <ol style="list-style-type: none"> 1. Battery (+) / Bateria (+) 2. GND / Masa 3. Battery (+) / Bateria (+) 4. GND / Masa 5. Power Coil / Bobina de Carga 6. Power Coil / Bobina de Carga 7. Power Coil / Bobina de Carga 	Gilera - 584533 Gilera Fuoco 500 2007 58086R Gilera Nexus 250 de 2006 a 2007 639110 Gilera Nexus 500 de 2003 a 2005 639110 Gilera Nexus IE 500 de 2006 a 2011 639110 Gilera Nexus 300 2008 639110 Gilera Nexus SP IE 500 de 2006 a 2007 639110
产品单重	240克			
检测程序	M325 2593			
电线插头	黄1.5 X 红黑20 黄线60CM			
内盒尺寸	12*9.5*6CM			
外箱尺寸	49.5*25.5*30.5CM			
输出电压	14.5±0.5V MOSFET 35安培			
一箱只数	50			
铝壳尺寸				
重要说明				
产品编号	R2002.5		 <ol style="list-style-type: none"> 1. Power Coil / Bobina de Carga (Yellow/ Amarillo) 2. Power Coil / Bobina de Carga (Yellow/ Amarillo) 3. Power Coil / Bobina de Carga (Yellow/ Amarillo) 4. Battery (+) / Bateria (+) 5. GND/ Masa 	2352 25A Reem lazo Shin ngen SH590A-13 Suzuki - 32800-49X50 Suzuki - 32800-47121 Suzuki GS T 750 1982 1983 32800- 47120 Suzuki GS L 450 1982 32800-44120 Suzuki GS E 650 1981 1982 32800- 47020 Suzuki GS E 500 1982 1983 32800- 47120
产品单重	240克			
检测程序	325 2303 2352			
电线插头	25CM			
内盒尺寸	12*9.5*6CM			
外箱尺寸	49.5*25.5*30.5CM			
输出电压	14.5±0.5V 25安培			
一箱只数	50			
铝壳尺寸				
重要说明				



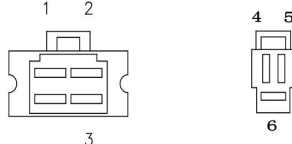

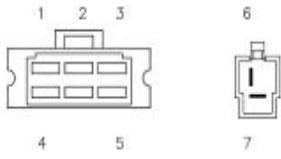

产品资料1		实物主图	接口图	适用范围
产品编号	R2002.5.1		 <p>1. Battery [+] / Bateria [+] (Red/Rojo) 2. GND / Masa (Black/Negro) 3. Power Coil / Bobina de Carga (Yellow/Amarillo) 4. Power Coil / Bobina de Carga (Yellow/Amarillo) 5. Power Coil / Bobina de Carga (Yellow/Amarillo)</p>	2305 25A Suzuki GR Tem ter 650 1983 Suzuki GS L 450 1984 1988 Suzuki GS E 700 1985 1986 Suzuki GS ES 750 1983 1985 Suzuki GS ESD 750 1983 1985 Suzuki GS EF 750 1983 1985 Suzuki GS ES/EF GS1150 1100 1984 1986 Suzuki GS ES GS1150 1100 1984 1986 Suzuki XN Turbo 85 1983
产品单重	240克			
检测程序	325 2305			
电线插头	25CM			
内盒尺寸	12*9.5*6CM			
外箱尺寸	49.5*25.5*30.5CM			
输出电压	14.5±0.5V 25安培			
一箱只数	50			
铝壳尺寸				
重要说明				
产品编号	R2002.6		 <p>1. GND 2. Battery (+) 3. Power Coil 4. Power Coil 5. Power Coil</p>	iaggio GTS 250 GTS 300
产品单重	240克			
检测程序	M325			
电线插头	所的1.5 X 25CM			
内盒尺寸	12*9.5*6CM			
外箱尺寸	49.5*25.5*30.5CM			
输出电压	14.5±0.5V			
一箱只数	50			
铝壳尺寸				
重要说明				
产品编号	R2002.7		 <p>1. Power Coil / Bobina de Carga 2. Power Coil / Bobina de Carga 3. Power Coil / Bobina de Carga 4. GND / Masa 5. GND / Masa 6. Ignition Switch / Sensor 7. Battery (+) / Bateria (+)</p>	2456 HondaATCES / SX250 1985 198731600-HA0-000 HondaTRX250 1985 198731600-HA8-770
产品单重	240克			
检测程序	325 2456			
电线插头	25CM			
内盒尺寸	12*9.5*6CM			
外箱尺寸	49.5*25.5*30.5CM			
输出电压	14.5±0.5V 25安培			
一箱只数	50			
铝壳尺寸				
重要说明				
产品编号	R2002.8		 <p>1. Power Coil / Bobina de Carga 2. Power Coil / Bobina de Carga 3. Power Coil / Bobina de Carga 4. Lights (+) / Luces (+) 5. Battery (+) / Bateria (+) 6. GND / Masa</p>	2429 Brava A olo 110 s 2013 Brava Daystar Routier 250 s 2014 Brava Nevada S 125 s 2013 Brava Nevada S 110 s 2013 Brava Nevada 125 s 2013 Corven Energy 110 s 2017 Gilera Smash 110 Gilera VC Naked 200 s 2013 Gilera VS 110 Guerrero Day G 70 s 2013
产品单重	240克			
检测程序	325 CC+LUCES 2429			
电线插头	25CM			
内盒尺寸	12*9.5*6CM			
外箱尺寸	49.5*25.5*30.5CM			
输出电压	14.5±0.5V 12安培			
一箱只数	50			
铝壳尺寸				
重要说明				

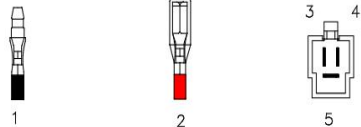

产品资料1		实物主图	接口图	适用范围
产品编号	R2002.08		 <p>1. Battery (+) / Batería (+) 2. GND / Masa</p> <p>3. Power Coil / Bobina de Carga 4. Power Coil / Bobina de Carga 5. Power Coil / Bobina de Carga</p>	2553 Blackstone Deportivo 250 Blackstone Deportivo 300 Guerrero GFT Mapuche 250
产品单重	240克			
检测程序	315 2553			
电线插头	25CM			
内盒尺寸	12*9.5*6CM			
外箱尺寸	49.5*25.5*30.5CM			
输出电压	14.5±0.5V 12安培			
一箱只数	50			
铝壳尺寸				
重要说明				
产品编号	R2002.8A		 <p>1. Ignition Switch / Sensor 2. Battery (+) / Batería (+) 3. GND / Masa</p> <p>4. Power Coil / Bobina de Carga 5. Power Coil / Bobina de Carga 6. Power Coil / Bobina de Carga</p>	10036 CorvenIndiana256 s 2012 GileraQM11A125hasta 200232500-2511 A GileraSmash110 GuerreroGM2000150 GuerreroGXL150 KonisaLX150 MaverickDual200 ZanellaZTTEnduro200 ZanellaZTTMotard200
产品单重	240克			
检测程序	325 10036			
电线插头	20CM			
内盒尺寸	12*9.5*6CM			
外箱尺寸	49.5*25.5*30.5CM			
输出电压	14.5±0.5V 12安培			
一箱只数	50			
铝壳尺寸				
重要说明				
产品编号	R2002.8B		 <p>1. Battery (+) / Batería (+) 2. GND / Masa</p> <p>3. Power Coil / Bobina de Carga 4. Power Coil / Bobina de Carga 5. Power Coil / Bobina de Carga</p>	2367 GileraAC4250 Hamatsu-200
产品单重	240克			
检测程序	325 2367 2377 2453 2553 10041			
电线插头	25CM			
内盒尺寸	12*9.5*6CM			
外箱尺寸	49.5*25.5*30.5CM			
输出电压	14.5±0.5V 12安培			
一箱只数	50			
铝壳尺寸				
重要说明				
产品编号	R2002.9		 <p>1. Ignition Switch / Sensor 2. Battery (+) / Batería (+) 3. GND / Masa</p> <p>4. Power Coil / Bobina de Carga 5. Power Coil / Bobina de Carga 6. Power Coil / Bobina de Carga</p>	Betamotor Eikon 125 Betamotor Eikon 150 Daelim S2 250 31600-SZ1-900 Honda CH / AC 250 1985 1988 31600- KS4-841 Honda CH / AC 250 1985 1988 31600- KM1-008 Honda CH / AC 150 1985 1986 31600- KM1-008 Honda CH / AC 150 1985 1986 31600- KS4-841
产品单重	240克			
检测程序	325			
电线插头	20CM			
内盒尺寸	12*9.5*6CM			
外箱尺寸	49.5*25.5*30.5CM			
输出电压	14.5±0.5V			
一箱只数	50			
铝壳尺寸				
重要说明				

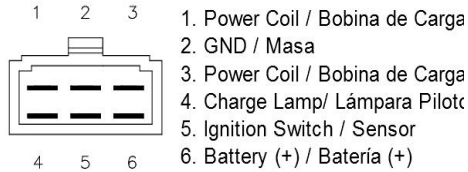

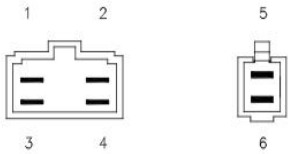

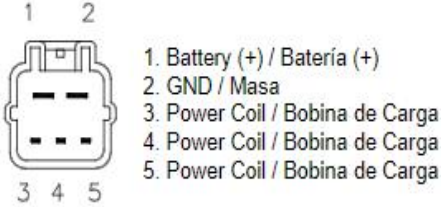

产品资料1		实物主图	接口图	适用范围
产品编号	R2002.9A		 <p>1. Ignition Switch / Sensor 2. Battery (+) / Batería (+) 3. GND / Masa</p> <p>4. Power Coil / Bobina de Carga 5. Power Coil / Bobina de Carga 6. Power Coil / Bobina de Carga</p>	2524 Honda CMX C 250 2001 2009 31600-KEN-A51 Honda CMX 2A / 3AC 250 2015 2016 31600-KEN-A51 Honda CMX C 250 2012 2014 31600-KEN-A51 Reem lazo Shin ngen SH535C-13 2497 Betamotor Eikon 150 Betamotor Eikon 125
产品单重	240克			
检测程序	325 2524 2497			
电线插头	20CM			
内盒尺寸	12*9.5*6CM			
外箱尺寸	49.5*25.5*30.5CM			
输出电压	14.5±0.5V 25安培			
一箱只数	50			
铝壳尺寸				
重要说明				
产品编号	R2002.10		 <p>1. Battery (+) / Batería (+) 2. Power Coil / Bobina de Carga 3. Power Coil / Bobina de Carga 4. Power Coil / Bobina de Carga 5. GND / Masa</p>	2304 25A Suzuki - 32800-43X51 Suzuki - 32800-43X50 Suzuki GS E / S 450 1984 1988 32800-35B00 Suzuki GS E / ES 1100 1982 1983 32800-49420 Suzuki GS L 550 1983 1986 32800-43400 Suzuki GS G / GK / GL 1100 1982 1983 32800-49420
产品单重	240克			
检测程序	325 2304			
电线插头	黑线25 其他 40CM			
内盒尺寸	12*9.5*6CM			
外箱尺寸	49.5*25.5*30.5CM			
输出电压	14.5±0.5V 25安培			
一箱只数	50			
铝壳尺寸				
重要说明				
产品编号	R2002.10A		 <p>1. Battery (+) / Batería (+) 2. Power Coil / Bobina de Carga 3. Power Coil / Bobina de Carga 4. Power Coil / Bobina de Carga 5. GND / Masa</p>	2336 25A Suzuki GS E 550 1983 1986 32800-43410 Suzuki GS L 550 1985 1986 32800-43410 Suzuki GSX E 550 1985 1987 32800-43410 Suzuki LT EF - QuadRunner 250 1985 1987 32800-24500 Suzuki LT E - QuadRunner 300 1987 1989 32800-24501
产品单重	240克			
检测程序	325 2336			
电线插头	35 CM			
内盒尺寸	12*9.5*6CM			
外箱尺寸	49.5*25.5*30.5CM			
输出电压	14.5±0.5V 25安培			
一箱只数	50			
铝壳尺寸				
重要说明				
产品编号	R2002.11		 <p>1. Battery (+) / Batería (+) 2. Power Coil / Bobina de Carga 3. Power Coil / Bobina de Carga 4. GND / Masa</p> <p>5. Power Coil / Bobina de Carga 6. Field Coil / Bobina de Campo 7. Ignition Switch / Sensor</p>	2412 Yamaha XS 1100 1978 1981 1T4-81960-A0-00 Yamaha XS 850 1980 1981 1T4-81960-A0-00 Yamaha XS 750 1978 1T4-81960-92-00 Yamaha XS 850 1980 1T4-81960-92-00 Yamaha XS 750 1977 1979 1T4-81960-A0-00 Yamaha XS 1100 1979 1980 1T4-81960-92-00
产品单重	240克			
检测程序	CB750+励磁 2412			
电线插头	35CM			
内盒尺寸	12*9.5*6CM			
外箱尺寸	49.5*25.5*30.5CM			
输出电压	14.5±0.5V 25安培			
一箱只数	50			
铝壳尺寸				
重要说明				

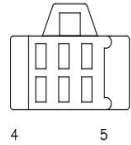

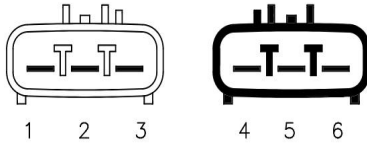

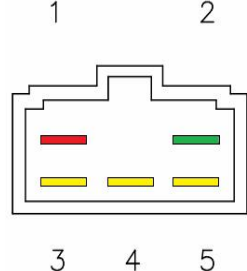

产品资料1		实物主图	接口图	适用范围
产品编号	R2002.12		 <p>1. Battery (+) / Bateria (+) 2. Ignition Switch / Sensor 3. GND / Masa 4. Battery (+) / Bateria (+) 5. GND / Masa 6. Power Coil / Bobina de Carga 7. Power Coil / Bobina de Carga 8. Power Coil / Bobina de Carga</p>	HONDA VT500/VT700/VT750/XL600V
产品单重	240克			
检测程序	325			
电线插头	35CM			
内盒尺寸	12*9.5*6CM			
外箱尺寸	49.5*25.5*30.5CM			
输出电压	14.5±0.5V			
一箱只数	50			
铝壳尺寸				
重要说明				
产品编号	R2002.13		 <p>1. Field Coil 2. GND 3. Battery (+) 4. Ignition Switch 5. Power Coil 6. Power Coil 7. Power Coil</p>	2481 25A CAM 0 - Reem lazo Shin ngen SH233-A12 Yamaha FJ 600 1984 1985 12R-81960-A1-00 Yamaha FZ 600 1986 1988 2XL-81960-A0-00 Yamaha XJ R Seca 650 1982 1983 4H7-81960-50 Yamaha XJ 600 1984 1986 12R-81960-A0-00 Yamaha XI R Seca 900 1983 1984 12R-
产品单重	240克			
检测程序	CB750+励磁 2481			
电线插头	35CM			
内盒尺寸	12*9.5*6CM			
外箱尺寸	49.5*25.5*30.5CM			
输出电压	14.5±0.5V 25安培			
一箱只数	50			
铝壳尺寸				
重要说明	3白线1红正1黑负1棕检测1绿线励磁			
产品编号	R2002.14		 <p>1. Power Coil / Bobina de Carga 2. Power Coil / Bobina de Carga 3. GND / Masa 4. Battery (+) / Bateria (+)</p>	2347 20A Kawasaki KZ F 650 1981 1984 Kawasaki KZ 440LTD 400 1979 1983 Kawasaki KZ C2 650 1978 1980 Kawasaki KZ LTD 650 1979 1983 Kawasaki KZ SR 650 1978 1981 Kawasaki KZ LTD TWIN 750 1982 1984 Kawasaki KZ LTD 305 1981 1988 Kawasaki KZ CSR 305 1981 1988 Kawasaki KZ C3 650 1978 1980 Kawasaki KZ CSR 650 1979 1983
产品单重	240克			
检测程序	215 2347			
电线插头	25CM			
内盒尺寸	12*9.5*6CM			
外箱尺寸	49.5*25.5*30.5CM			
输出电压	14.5±0.5V 35安培			
一箱只数	50			
铝壳尺寸				
重要说明				
产品编号	R2002.15		 <p>1. Ignition Switch / Sensor 2. Battery (+) / Bateria (+) 3. GND / Masa 4. Power Coil / Bobina de Carga 5. Power Coil / Bobina de Carga 6. Power Coil / Bobina de Carga</p>	2468 Arctic CatUtility250 2006 20093303-836 Arctic CatUtility300 2010 20163303-836 Arctic CatUtility150 2009 20193303-836 Can AmDS250 2006 2015S31600RCA000 KymcoMXU250 2004 200831600-LBA7-900 KymcoMXU300 2005 201131600-LBA7-900 KymcoMXU150 2005 201131600-LBA7-900
产品单重	240克			
检测程序	M325 2468 2467			
电线插头	25CM			
内盒尺寸	12*9.5*6CM			
外箱尺寸	49.5*25.5*30.5CM			
输出电压	14.5±0.5V 35安培			
一箱只数	50			
铝壳尺寸				
重要说明				

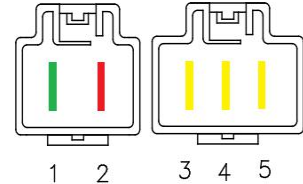

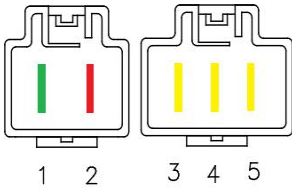

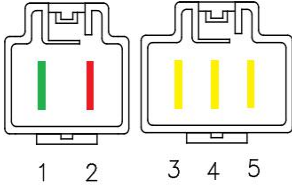

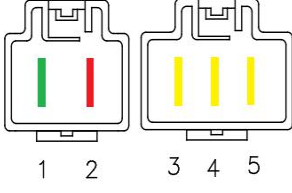
产品资料1		实物主图	接口图	适用范围
产品编号	R2002.16		 <ol style="list-style-type: none"> 1. Battery (+) / Bateria (+) 2. GND / Masa 3. Power Coil / Bobina de Carga 4. Power Coil / Bobina de Carga 5. Power Coil / Bobina de Carga 	2311 25A Kawasaki EL Eliminator 250 1988 1989 Kawasaki EN Vulcan 500 1990 2001 Kawasaki EN 450 1985 1990 Kawasaki EX NINJA 500 1987 2001 Kawasaki EX 500 1987 2001 Kawasaki G Z 1100 1981 1985 Kawasaki G Z E Turbo 750 1984 1985 Kawasaki KZ R 1000 1982 1983 Kawasaki KZ Shaft 1100 1981 1983
产品单重	240克			
检测程序	325 2311			
电线插头	20CM			
内盒尺寸	12*9.5*6CM			
外箱尺寸	49.5*25.5*30.5CM			
输出电压	14.5±0.5V 25安培			
一箱只数	50			
铝壳尺寸				
重要说明				
产品编号	R2002.16A		 <ol style="list-style-type: none"> 1. Ignition Switch / Sensor 2. Battery (+) / Bateria (+) 3. GND / Masa 4. Power Coil / Bobina de Carga 5. Power Coil / Bobina de Carga 6. Power Coil / Bobina de Carga 	2068 25A Kawasaki - 21066-1028 Kawasaki BJ Estrella 250 1994 21066-1030 Kawasaki EL Eliminator 250 1988 2003 21066-1030 Kawasaki EL HS 250 1991 1994 21066-1030 Kawasaki EN LTD 454 1985 1990 21066-1030 Kawasaki EN Vulcan 400 1989 1994
产品单重	240克			
检测程序	325 2068			
电线插头	25CM			
内盒尺寸	12*9.5*6CM			
外箱尺寸	49.5*25.5*30.5CM			
输出电压	14.5±0.5V 25安培			
一箱只数	50			
铝壳尺寸				
重要说明	棕线检测 红正绿负			
产品编号	R2002.17		 <ol style="list-style-type: none"> 1. Power Coil / Bobina de Carga 2. Power Coil / Bobina de Carga 3. Power Coil / Bobina de Carga 4. GND / Masa 5. Battery (+) / Bateria (+) 	2408 20A Reem lazo Shin ngen SH572MB Suzuki AN 125 2000 32800-22D11 Suzuki AN Burgman 250 1996 2000 32800-22D10 Suzuki AN Burgman 125 1995 2000 32800-22D10 Suzuki EN 125 2004 2008 32800-22D20 Suzuki EN A2 125 32800-37G10-000 Suzuki GN 125 32800-37G10-000 Suzuki GSX 250 1991 1997 32800-
产品单重	240克			
检测程序	M325 2396 2408			
电线插头	25CM			
内盒尺寸	12*9.5*6CM			
外箱尺寸	49.5*25.5*30.5CM			
输出电压	14.5±0.5V 25安培			
一箱只数	50			
铝壳尺寸				
重要说明				
产品编号	R2002.18		 <ol style="list-style-type: none"> 1. Battery (+) / Bateria (+) 2. Battery (+) / Bateria (+) 3. GND / Masa 4. GND / Masa 5. Power Coil / Bobina de Carga 6. Power Coil / Bobina de Carga 7. Power Coil / Bobina de Carga 	2541 PolarisOutlaw450 2008 20104012536 PolarisOutlaw500 2006 20074012536 PolarisOutlawS / IRS525 2007 2011 4012536 Polaris redator500 2003 2007 4010654
产品单重	240克			
检测程序	325 2454 2541			
电线插头	25CM			
内盒尺寸	12*9.5*6CM			
外箱尺寸	49.5*25.5*30.5CM			
输出电压	14.5±0.5V 35安培			
一箱只数	50			
铝壳尺寸				
重要说明	交流黑线 正极2红负极2绿			

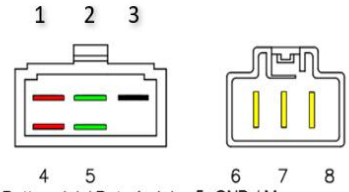
产品资料1		实物主图	接口图	适用范围
产品编号	R2002.19		 <p>1. GND / Masa 2. Battery (+) / Bateria (+) 3. Power Coil / Bobina de Carga 4. Power Coil / Bobina de Carga 5. Power Coil / Bobina de Carga</p>	2343 25A Reem lazo ietcard 1376 Yamaha YFB Timberwolf 250 1998 2000 4KB-81960-02 Yamaha YFB250 1997 4KB-81960-01 Yamaha YFB Timberwolf 250 1997 4KB-81960-01 Yamaha YFM Wolverine 350 1996 1997 4KB-81960-01 Yamaha YFM350 1997 4KB-81960-01 Yamaha YFM Grizzly 600 1998 4KB-
产品单重	240克			
检测程序	315 2343			
电线插头	25 黄线30CM			
内盒尺寸	12*9.5*6CM			
外箱尺寸	49.5*25.5*30.5CM			
输出电压	14.5±0.5V 25安培			
一箱只数	50			
铝壳尺寸				
重要说明				
产品编号	R2002.20		 <p>1. Power Coil / Bobina de Carga 2. GND / Masa 3. Power Coil / Bobina de Carga 4. Charge Lamp / Lámpara Pilot 5. Ignition Switch / Sensor 6. Battery (+) / Bateria (+)</p>	Grassho er 1822D 185530 Grassho er 718D 185530 Grassho er 721D 185530 Grassho er 721G 185530 JOHN DEERE Tractor 750 M802471 JOHN DEERE Tractor 650 M802471 MIA881277 CH15589 Kubota 821G RS 5101 RS5101 RS5155 15351-64600 15351-64601
产品单重	净重240克 盒重270克			
检测程序	QF2101 新 2328			
电线插头	20CM			
内盒尺寸	12*9.5*6CM			
外箱尺寸	49.5*25.5*30.5CM			
输出电压	14.5±0.5V 20安培			
一箱只数	50			
铝壳尺寸				
重要说明	6插带钩 白色铝壳			
产品编号	R2002.21		 <p>1. Battery (+) / Bateria (+) 2. GND / Masa 3. Power Coil / Bobina de Carga 4. Power Coil / Bobina de Carga 5. Battery (+) / Bateria (+) 6. GND / Masa</p>	John AM109462 Kawasaki 21066-2071 Reem SH637-12
产品单重	240克			
检测程序	215 2318			
电线插头	20CM			
内盒尺寸	12*9.5*6CM			
外箱尺寸	49.5*25.5*30.5CM			
输出电压	14.5±0.5V 20安培			
一箱只数	50			
铝壳尺寸				
重要说明	2黄线交流 2红正2 黑负 白色铝壳			
产品编号	R2002.22		 <p>1. Battery (+) / Bateria (+) 2. GND / Masa 3. Power Coil / Bobina de Carga 4. Power Coil / Bobina de Carga 5. Power Coil / Bobina de Carga</p>	YamahaYFMWarrior350 2002 20044KB-81960-10 YamahaYFMWolverine350 2002 20054KB-81960-10
产品单重	240克			
检测程序	325 2573			
电线插头	15CM			
内盒尺寸	12*9.5*6CM			
外箱尺寸	49.5*25.5*30.5CM			
输出电压	14.5±0.5V 20安培			
一箱只数	50			
铝壳尺寸				
重要说明				

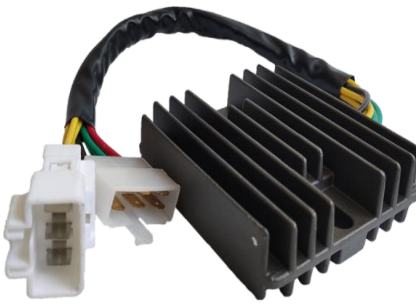
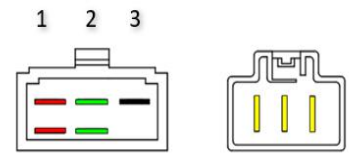

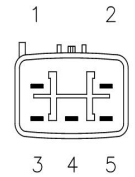

产品资料1		实物主图	接口图	适用范围
产品编号	R2002.23		 <p>1 2 3 4 5 6</p> <p>1. Power Coil / Bobina de Carga 2. Power Coil / Bobina de Carga 3. Power Coil / Bobina de Carga 4. GND / Masa 5. Battery (+) / Bateria (+) 6. Lights (+) / Luces (+)</p>	2528 CorvenEnergy110 2015 2016 KellerQuasarNK olicia2602014 KellerQuasarNK2602014 KellerStratusR2602014 UniversalLuces Encendidas
产品单重	240克			
检测程序	325 2528			
电线插头	20CM			
内盒尺寸	12*9.5*6CM			
外箱尺寸	49.5*25.5*30.5CM			
输出电压	14.5±0.5V 12安培			
一箱只数	50			
铝壳尺寸				
重要说明				
产品编号	R2002.24		 <p>1 2 3 4 5</p> <p>1. Battery (+) / Bateria (+) 2. GND / Masa 3. Power Coil / Bobina de Carga 5. Power Coil / Bobina de Carga 6. Power Coil / Bobina de Carga</p>	10076 ZanellaTractorATV250 s 2005
产品单重	240克			
检测程序	325 10076			
电线插头	黄线25 红黑线35CM			
内盒尺寸	12*9.5*6CM			
外箱尺寸	49.5*25.5*30.5CM			
输出电压	14.5±0.5V 12安培			
一箱只数	50			
铝壳尺寸				
重要说明	三黄1 红1 黑			
产品编号	R2002.25		 <p>1 2 3 4 5</p> <p>1. Power Coil / Bobina de Carga 2. Lights (+) / Luces (+) 3. GND / Masa 4. Battery (+) / Bateria (+) 5. Power Coil / Bobina de Carga</p>	2529 BravaAltino1802014 BravaAltino1502014 BravaElektra1502014 CorvenMirage110 s 2015 antherQuads2502011 UniversalLuces Encendidas ZanellaZR250 s 2012 ZanellaZTTZR Enduro250
产品单重	240克			
检测程序	325 2529			
电线插头	20CM			
内盒尺寸	12*9.5*6CM			
外箱尺寸	49.5*25.5*30.5CM			
输出电压	14.5±0.5V 12安培			
一箱只数	50			
铝壳尺寸				
重要说明				
产品编号	R2002.26		 <p>1 2 3 4 5 6 7 8</p> <p>1. Power Coil / Bobina de Carga (Yellow/ Amarillo) 2. Power Coil / Bobina de Carga (Yellow/ Amarillo) 3. Power Coil / Bobina de Carga (Yellow/ Amarillo) 4. Field Coil (-) / Bobina de Campo (-) (Black/ Negro) 5. Field Coil (+) / Bobina de Campo (+) (Brown/ Marrón) 6. Ignition Switch / Sensor (Orange/ Naranja) 7. Battery (+) / Bateria (+) (Red/ Rojo) 8. GND / Masa (Green/ Verde)</p>	2512 BMWR60/5600197312321244409 + 12311244063 BMWR60/7600 1977 197812321244409 + 12311244063 BMWR75/7750197712321244409 + 12311244063 BMWR60/6600 1974 197612321244409 + 12311244063 BMWR50/5500 1970 197312321244409 + 12311244063 BMWR80RT800 1982 198712321244409 +
产品单重	300克			
检测程序	CB750 2512			
电线插头				
内盒尺寸	12*9.5*6CM			
外箱尺寸	49.5*25.5*30.5CM			
输出电压	14.5±0.5V 25安培			
一箱只数	50			
铝壳尺寸	安装孔距60MM			
重要说明	CAMPO +			

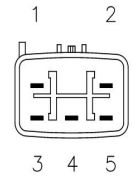



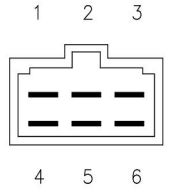

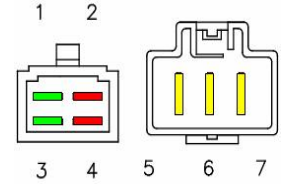
产品资料1		实物主图	接口图	适用范围
产品编号	R2002A.0	6针 	 1. Power Coil / Bobina de Carga 4. Battery (+) / Bateria (+) 2. Power Coil / Bobina de Carga 5. AC Output / Salida AC 3. Power Coil / Bobina de Carga 6. GND / Masa	2434 Kawasaki ZX 6R Ninja 600 2013 2017 21066-0716 Kawasaki ZX 6R Ninja 600 2016 2017 21066-0730 Kawasaki ZX 6R Ninja 600 2009 2013 21066-0028 Kawasaki ZX 10R Ninja 1000 2008 2015 21066-0731 Reem lazo Kokusan nki RX45
产品单重	240克			
检测程序	M325 2434			
电线插头	3针+3针			
内盒尺寸	12*9.5*6CM			
外箱尺寸	49.5*25.5*30.5CM			
输出电压	14.5±0.5V 35安培			
一箱只数	50			
铝壳尺寸				
重要说明	6针 5号针是接AC			
产品编号	R2002B.1	6针 	 1. Battery (+) / Bateria (+) 2. GND / Masa 3. Power Coil / Bobina de Carga 4. Power Coil / Bobina de Carga 5. Power Coil / Bobina de Carga	2376 Kawasaki KAF MULE 4010 620 s 2014 21066-0717 Kawasaki KAF MULE 4000 620 2009 2012 21066-0037 Kawasaki KAF MULE 4000 620 s 2014 21066-0717 Kawasaki KAF MULE 4010 620 2009 2012 21066-0037 Suzuki LT-A KingQuad K8/K9 400 2008 2010 32800-38F10
产品单重	净重165克			
检测程序	M325 2376			
电线插头	6针插头			
内盒尺寸	12*9.5*6CM			
外箱尺寸	49.5*25.5*30.5CM			
输出电压	14.5±0.5V 35安培			
一箱只数	50			
铝壳尺寸				
重要说明				
产品编号	R2002B.2		 1. Battery (+) 2. GND 3. Power Coil 4. Power Coil 5. Power Coil	Benelli 125 iaggio 580 90R
产品单重	净重165克			
检测程序	M325			
电线插头	5针插头			
内盒尺寸	12*9.5*6CM			
外箱尺寸	49.5*25.5*30.5CM			
输出电压	14.5±0.5V 35安培			
一箱只数	50			
铝壳尺寸				
重要说明	5插			
产品编号	R2002B.3		 1. GND 2. Battery (+) 3. Power Coil 4. Power Coil 5. Power Coil	Piaggio 58204R Piaggio FLY 125 2006-2015 Piaggio LIBERTY 125 2006-2015 Piaggio LIBERTY 150 2008-2014 Vespa Vespa 946 125 2013-2017 Vespa LX 125 2006-2014
产品单重				
检测程序	M325			
电线插头	15 25CM			
内盒尺寸	12*9.5*6CM			
外箱尺寸	49.5*25.5*30.5CM			
输出电压	14.5±0.5V 35安培			
一箱只数	50			
铝壳尺寸				
重要说明	5插			

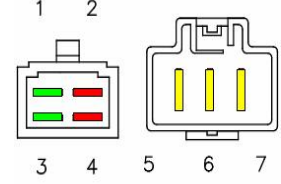
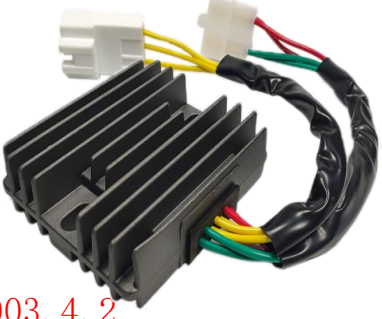
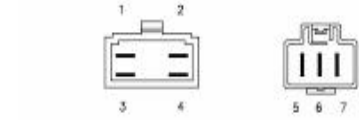

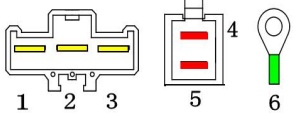
产品资料1		实物主图	接口图	适用范围
产品编号	R2003.0		 <ul style="list-style-type: none"> 1. GND 2. Battery (+) 3. Power Coil 4. Power Coil 5. Power Coil 	2444 Honda CBR RR 1000 2004 2005 31600-MEL-013 Honda CBR RR 600 2007 2011 31600-MEL-821 Honda CBR RA 600 2009 2011 31600-MEL-821 Reem lazo Shin ngen SH678FD Reem lazo Shin ngen SH678FB
产品单重	310克			
检测程序	M325 2444			
电线插头	所有1.5 X 25CM			
内盒尺寸	12*9.5*6CM			
外箱尺寸	49.5*25.5*30.5CM			
输出电压	14.5±0.5V M50安培			
一箱只数	50			
铝壳尺寸				
重要说明				
产品编号	R2003.0A		 <ul style="list-style-type: none"> 1. GND 2. Battery (+) 3. Power Coil 4. Power Coil 5. Power Coil 	2444 Honda CBR RR 1000 2004 2005 31600-MEL-013 Honda CBR RR 600 2007 2011 31600-MEL-821 Honda CBR RA 600 2009 2011 31600-MEL-821 Reem lazo Shin ngen SH678FD Reem lazo Shin ngen SH678FB
产品单重	310克			
检测程序	M325 2444			
电线插头	所有1.5 X 25CM			
内盒尺寸	12*9.5*6CM			
外箱尺寸	49.5*25.5*30.5CM			
输出电压	14.5±0.5V M50安培			
一箱只数	50			
铝壳尺寸				
重要说明	3黄1 红1 绿			
产品编号	R2003.0B		 <ul style="list-style-type: none"> 1. GND 2. Battery (+) 3. Power Coil 4. Power Coil 5. Power Coil 	Honda VT 1300 C VT1300C R / S / T / X 2010-2020 31600-MFR-671
产品单重	310克			
检测程序	M325 2444			
电线插头	所有1.5 X35CM			
内盒尺寸	12*9.5*6CM			
外箱尺寸	49.5*25.5*30.5CM			
输出电压	14.5±0.5V M50安培			
一箱只数	50			
铝壳尺寸				
重要说明	3黄2红2绿 配一个黑色3插带铜件			
产品编号	R2003.0.1		 <ul style="list-style-type: none"> 1. Battery (+) / Bateria (+) 2. GND / Masa 3. Ignition Switch / Sensor 4. Battery (+) / Bateria (+) 5. GND / Masa 6. Power Coil / Bobina de Carga 7. Power Coil / Bobina de Carga 8. Power Coil / Bobina de Carga 	2402 Honda CBR 954 Firebla 900 2002 2003 31600-MCJ-750 Reem lazo Shin ngen SH678-DA 2403 Honda - 31600-MBG-D00 Honda CBR 1100 1999 2000 31600-MAT-E01 Honda CBR XX Blackbird 1100 1999 2000 31600-MAT-E01 Reem lazo Shin ngen SH579C-12
产品单重	310克			
检测程序	M325 2402 2403			
电线插头	黄1.5 X 35CM			
内盒尺寸	12*9.5*6CM			
外箱尺寸	49.5*25.5*30.5CM			
输出电压	14.5±0.5V 35安培			
一箱只数	50			
铝壳尺寸				
重要说明	有胶套			

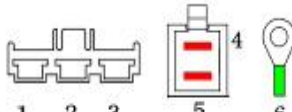

产品资料1		实物主图	接口图	适用范围
产品编号	R2003.0.2		 <p>1 2 3</p> <p>4 5</p> <p>6 7 8</p> <p>1. Battery (+) / Bateria (+) 5. GND / Masa 2. GND / Masa 6. Power Coil / Bobina de Carga 3. Ignition Switch / Sensor 7. Power Coil / Bobina de Carga 4. Battery (+) / Bateria (+) 8. Power Coil / Bobina de Carga</p>	2491 Honda CB SF X-11 1100 2000 2003 31600-MCC-601 Reem lazo Shin ngen SH579C-12
产品单重	310克			
检测程序	M325 2491			
电线插头	黄1.5 X 35CM			
内盒尺寸	12*9.5*6CM			
外箱尺寸	49.5*25.5*30.5CM			
输出电压	14.5±0.5V 35安培			
一箱只数	50			
铝壳尺寸				
重要说明				
产品编号	R2003.1		 <p>1 2 3</p> <p>4 5 6</p> <p>1. Ignition Switch / Sensor 2. Battery (+) / Bateria (+) 3. GND / Masa 4. Power Coil / Bobina de Carga 5. Power Coil / Bobina de Carga 6. Power Coil / Bobina de Carga</p>	Kawasaki - 21066-1028 Kawasaki BJ Estrella 250 1994 21066-1030 Kawasaki EL Eliminator 250 1988 2003 21066-1030 Kawasaki EL HS 250 1991 1994 21066-1030 Kawasaki EN LTD 454 1985 1990 21066-1030 Kawasaki EN Vulcan 400 1989 1994
产品单重	310克			
检测程序	325			
电线插头	25CM			
内盒尺寸	12*9.5*6CM			
外箱尺寸	49.5*25.5*30.5CM			
输出电压	14.5±0.5V			
一箱只数	50			
铝壳尺寸				
重要说明	黑线红线棕色线			
产品编号	R2003.2		 <p>1 2</p> <p>3 4 5</p> <p>1. Battery (+) / Bateria (+) 2. GND / Masa 3. Power Coil / Bobina de Carga 4. Power Coil / Bobina de Carga 5. Power Coil / Bobina de Carga</p>	2365 Kawasaki JT ULTRA LX 1500 2007 2019 21066-3718 Kawasaki JT ULTRA 300LX 1500 2011 2013 21066-3718 Kawasaki JT ULTRA 300X 1500 2011 2013 21066-3718 Kawasaki JT ULTRA 260X 1500 2009 2010 21066-3718 Kawasaki JT ULTRA 310LX 1500 2014 2019 21066-3718
产品单重	250克			
检测程序	325 2365 2376 2375 2364 2378			
电线插头	6针插头			
内盒尺寸	12*9.5*6CM			
外箱尺寸	49.5*25.5*30.5CM			
输出电压	14.5±0.5V 35安培			
一箱只数	50			
铝壳尺寸				
重要说明				
产品编号	R2003.2+D		 <p>1 2</p> <p>3 4 5</p> <p>1. Battery (+) / Bateria (+) 2. GND / Masa 3. Power Coil / Bobina de Carga 4. Power Coil / Bobina de Carga 5. Power Coil / Bobina de Carga</p>	产品编号2003.2-D
产品单重	250克			
检测程序	325			
电线插头	6针插头			
内盒尺寸	12*9.5*6CM			
外箱尺寸	49.5*25.5*30.5CM			
输出电压	14.5±0.5V			
一箱只数	50			
铝壳尺寸				
重要说明				

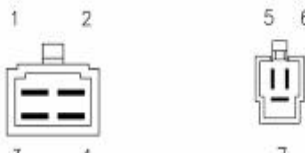

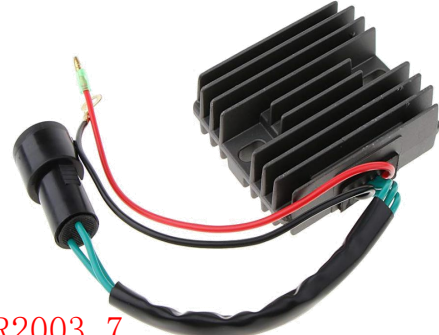
产品资料1		实物主图	接口图	适用范围
产品编号	R2003.2+DX		 <ol style="list-style-type: none"> 1. Battery (+) / Bateria (+) 2. GND / Masa 3. Power Coil / Bobina de Carga 4. Power Coil / Bobina de Carga 5. Power Coil / Bobina de Carga 	替换部件号：6D3-81960-00、68V-81960-00、881346T配件 : 适用于水星Mercruiser F115 适用于Mercruiser F100 适用于Mercruiser F90 适用于Mercruiser F80 适用于Mercruiser F75适用
产品单重	250克			
检测程序	325			
电线插头	6针插头 对插长度15CM			
内盒尺寸	12*9.5*6CM			
外箱尺寸	49.5*25.5*30.5CM			
输出电压	14.5±0.5V			
一箱只数	50			
铝壳尺寸				
重要说明				
产品编号	R2003.2+DX1		 <ol style="list-style-type: none"> 1. Battery (+) / Bateria (+) 2. GND / Masa 3. Power Coil / Bobina de Carga 4. Power Coil / Bobina de Carga 5. Power Coil / Bobina de Carga 	
产品单重				
检测程序	325			
电线插头	6针插头 对插长度20CM			
内盒尺寸	12*9.5*6CM			
外箱尺寸	49.5*25.5*30.5CM			
输出电压	14.5±0.5V			
一箱只数	50			
铝壳尺寸				
重要说明				
产品编号	R2003.3	5针 	 <ol style="list-style-type: none"> 1. Battery (+) 2. GND 3. Power Coil 4. Power Coil 5. Power Coil 	YHC012 Yamaha V-STAR XVS400 DS400 1996-2008 Yamaha FZR600 1994-1995 XT660 2004-2014 Yamaha FZ6R 2009-2013 Yamaha YZF R1 1999-2001 Yamaha YZF600 1996-2005 Yamaha X 500 T-MAX500 2001-2006 Yamaha TDM850 4TX TDM 850 1996-2001 Yamaha FZ6 FZ6N FZ6S 2004-2009 Yamaha YZF R6 2003-2005
产品单重	250克			
检测程序	325			
电线插头	5针插头			
内盒尺寸	12*9.5*6CM			
外箱尺寸	49.5*25.5*30.5CM			
输出电压	14.5±0.5V			
一箱只数	50			
铝壳尺寸				
重要说明				
产品编号	R2003.3.1	6针 	 <ol style="list-style-type: none"> 1. Battery (+) / Bateria (+) 2. Ignition Switch / Sensor 3. GND / Masa 4. Power Coil / Bobina de Carga 5. Charge Lamp / Lámpara Piloto 6. Power Coil / Bobina de Carga 	OEM: M97348 AM70121 AM126304 21066-2056 21066-2070 SH626-12 M97348 JJOHN DEERE 130 15A M70121 JOHN DEERE 160 15A M70121 JOHN DEERE 165 15A M70121 JOHN DEERE 170 15A M70121 JOHN DEERE 172 15A M70121 JOHN DEERE 175 15A M70121 JOHN DEERE 176 15A M70121 JOHN DEERE 180 15A M70121 JOHN DEERE 185 15A M70121
产品单重	250克			
检测程序	QF2101 2317 2316			
电线插头	6针插头			
内盒尺寸	12*9.5*6CM			
外箱尺寸	49.5*25.5*30.5CM			
输出电压	14.5±0.5V 20安培			
一箱只数	50			
铝壳尺寸				
重要说明	接上交流 指示灯电压12V->0V			
		R2003.3.1	R2003.3.1	



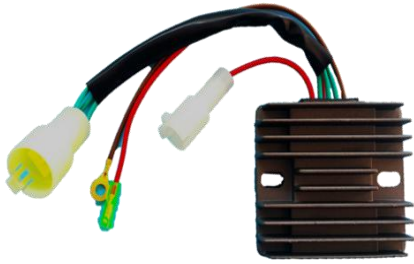
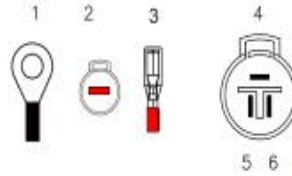
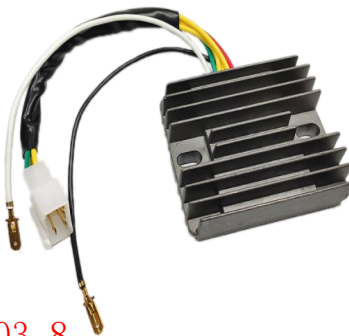
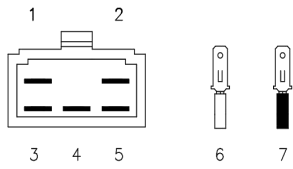
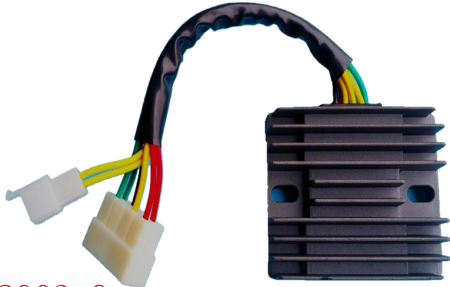
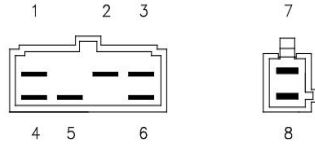

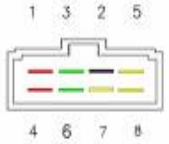
产品资料1		实物主图	接口图	适用范围
产品编号	R2003.3.2		 <ol style="list-style-type: none"> 1. Battery (+) / Bateria (+) 2. Ignition Switch / Sensor 3. GND / Masa 4. Power Coil / Bobina de Carga 5. Power Coil / Bobina de Carga 6. Power Coil / Bobina de Carga 	OEM: 21066-1038 SH548-12 / 21066-1052 SH561-12 SH560A-12 Kawasaki KLF Bayou 220cc (1996 - 2002) Kawasaki KLF Bayou 185cc (1986 - 1987) Kawasaki KLF Bayou 220cc (1988 - 1995) Kawasaki KLF Bayou 250cc (2003 - 2011) Kawasaki KLF Mojave 110cc (1987 - 2404)
产品单重	250克			
检测程序	325			
电线插头	6针插头			
内盒尺寸	12*9.5*6CM			
外箱尺寸	49.5*25.5*30.5CM			
输出电压	14.5±0.5V			
一箱只数	50			
铝壳尺寸				
重要说明				
产品编号	R2003.4		 <ol style="list-style-type: none"> 1. GND 2. Battery (+) 3. GND 4. Battery (+) 5. Power Coil 6. Power Coil 7. Power Coil 	Honda CBR RR 929 2001 2003 31600-MCJ-641 Honda CBR RE 929 2001 2003 31600-MCJ-641 Reem lazo Shin ngen SH678C-13 2414 Honda CBR RR 600 2003 31600-MEE-003 Honda CBR RR 600 2004 2006 31600-MEE-872 SH678C-13
产品单重	310克			
检测程序	M325 2404 2414			
电线插头	黄1.5 X 35CM			
内盒尺寸	12*9.5*6CM			
外箱尺寸	49.5*25.5*30.5CM			
输出电压	14.5±0.5V 35安培			
一箱只数	50			
铝壳尺寸				
重要说明				
产品编号	R2003.4.1		 <ol style="list-style-type: none"> 1. GND 2. Battery (+) 3. GND 4. Battery (+) 5. Power Coil 6. Power Coil 7. Power Coil 	2484 Honda CBR RR 600 2003 31600-MEE-003 Honda CBR RR 600 2004 2006 31600-MEE-872 Reem lazo Shin ngen SH678-FA 2404 Honda CBR RR 929 2001 2003 31600-MCJ-641 Honda CBR RE 929 2001 2003 31600-MCJ-641 Reem lazo Shin ngen SH678C-13
产品单重	310克			
检测程序	M325 2404 2414 2484			
电线插头	黄1.5 X 35CM			
内盒尺寸	12*9.5*6CM			
外箱尺寸	49.5*25.5*30.5CM			
输出电压	14.5±0.5V 35安培			
一箱只数	50			
铝壳尺寸				
重要说明				
产品编号	R2003.4.2		 <ol style="list-style-type: none"> 1. GND / Masa 2. Battery (+) / Bateria (+) 3. GND / Masa 4. Battery (+) / Bateria (+) 5. Power Coil / Bobina de Carga 6. Power Coil / Bobina de Carga 7. Power Coil / Bobina de Carga 	2461 Honda CBR F4i 600 2001 2004 31600-MBW-D21 Honda CBR F4i 600 2005 2006 31600-MBW-G90 Reem lazo Shin ngen SH678 A
产品单重	310克			
检测程序	M325 2461			
电线插头	黄1.5 +65CM			
内盒尺寸	12*9.5*6CM			
外箱尺寸	49.5*25.5*30.5CM			
输出电压	14.5±0.5V 35安培			
一箱只数	50			
铝壳尺寸				
重要说明				

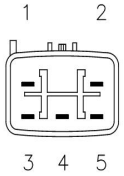

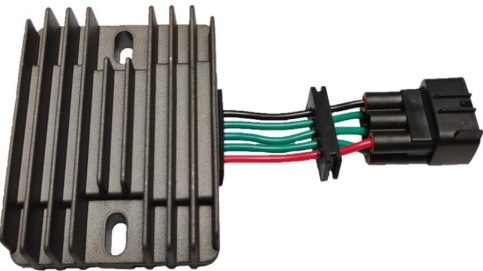
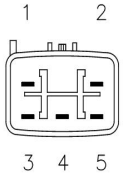

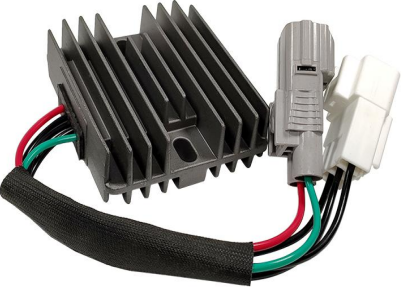
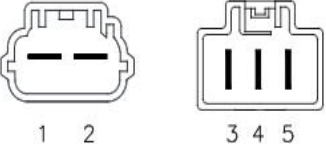

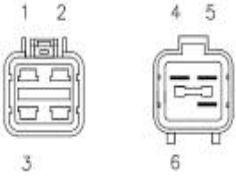
产品资料1		实物主图	接口图	适用范围
产品编号	R2003.5		 <p>1. Power Coil / Bobina de Carga 2. Power Coil / Bobina de Carga 3. Power Coil / Bobina de Carga 4. Battery (+) / Bateria (+) 5. Battery (+) / Bateria (+) 6. GND/ Masa</p>	YHC110/SKU462082 KTM 690 Duke;KTM 990 Su ermoto SM 2008-2011 KTM 690 Enduro KTM 690 Har nduro KTM 690 SMC KTM 690 Su ermotoR KTM Adventure 990 LC8 2008-2010 KTM Su ermoto 690 R 2008 KTM RC8 1190 2008-2012 KTM 990 Su ermoto SM 2008-2011
产品单重	310克			
检测程序	M325			
电线插头	黄1.5 X 25CM			
内盒尺寸	12*9.5*6CM			
外箱尺寸	49.5*25.5*30.5CM			
输出电压	14.5±0.5V			
一箱只数	50			
铝壳尺寸				
重要说明				
产品编号	R2003.5.1		 <p>1. Power Coil / Bobina de Carga 2. Power Coil / Bobina de Carga 3. Power Coil / Bobina de Carga 4. Battery (+) / Bateria (+) 5. Battery (+) / Bateria (+) 6. GND/ Masa</p>	KTM 690 Duke;KTM 990 Su ermoto SM 2008-2011 KTM 690 Enduro KTM 690 Har nduro KTM 690 SMC KTM 690 Su ermotoR KTM Adventure 990 LC8 2008-2010 KTM Su ermoto 690 R 2008 KTM RC8 1190 2008-2012 KTM 990 Su ermoto SM 2008-2011
产品单重	310克			
检测程序	M325			
电线插头	黄1.5 X 25CM			
内盒尺寸	12*9.5*6CM			
外箱尺寸	49.5*25.5*30.5CM			
输出电压	14.5±0.5V			
一箱只数	50			
铝壳尺寸				
重要说明				
产品编号	R2003.6		 <p>1. Battery (+) / Bateria (+) 2. GND / Masa 3. Battery (+) / Bateria (+) 4. GND / Masa 5. Power Coil / Bobina de Carga 6. Power Coil / Bobina de Carga 7. Power Coil / Bobina de Carga</p>	Ducati 999 999S SH579EA 03-06 D006 Ducati Multistrada 1000 SH579EA Ducati Streetfighter 848
产品单重	310克			
检测程序	M325			
电线插头	黄1.5 X 20 30CM			
内盒尺寸	12*9.5*6CM			
外箱尺寸	49.5*25.5*30.5CM			
输出电压	14.5±0.5V			
一箱只数	50			
铝壳尺寸				
重要说明	白色3 插不带钩			
产品编号	R2003.6.1		 <p>1. Battery (+) / Bateria (+) 2. GND / Masa 3. Battery (+) / Bateria (+) 4. GND / Masa 5. Power Coil / Bobina de Carga 6. Power Coil / Bobina de Carga 7. Power Coil / Bobina de Carga</p>	32800-02F00 TL1000 TL 1000 S 1997-2001 TL1000 TL 1000 R 1998-2003
产品单重	310克			
检测程序	M325			
电线插头	黄1.5 X 25CM			
内盒尺寸	12*9.5*6CM			
外箱尺寸	49.5*25.5*30.5CM			
输出电压	14.5±0.5V			
一箱只数	50			
铝壳尺寸				
重要说明				

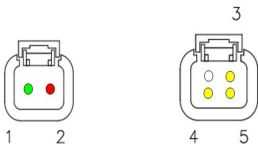

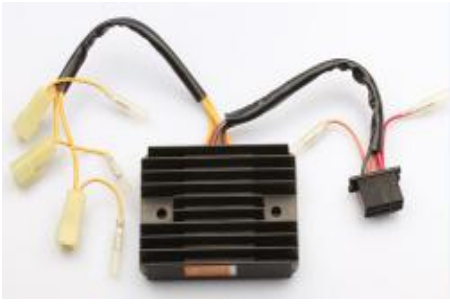
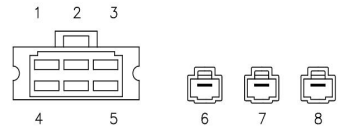

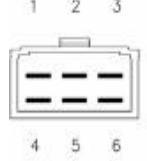

产品资料1		实物主图	接口图	适用范围
产品编号	R2003.6.2		 <p>1. Battery (+) / Bateria (+) 2. GND / Masa 3. Battery (+) / Bateria (+) 4. GND / Masa</p> <p>5. Power Coil / Bobina de Carga 6. Power Coil / Bobina de Carga 7. Power Coil / Bobina de Carga</p>	32800-02F00 SH579B-11 CAGIVA 900 TL1000 TL 1000 S 1997-2001 TL1000 TL 1000 R 1998-2003
产品单重	310克			
检测程序	M325			
电线插头	黄1.5 X 25CM			
内盒尺寸	12*9.5*6CM			
外箱尺寸	49.5*25.5*30.5CM			
输出电压	14.5±0.5V			
一箱只数	50			
铝壳尺寸				
重要说明				
产品编号	R2003.6.3		 <p>1. Battery (+) / Bateria (+) 2. GND / Masa 3. Battery (+) / Bateria (+) 4. GND / Masa</p> <p>5. Power Coil / Bobina de Carga 6. Power Coil / Bobina de Carga 7. Power Coil / Bobina de Carga</p>	Honda VT Shadow 600 31600-MY0-771 Honda VT C 600 1988 31600-MR1-000 Honda VT C 600 de 1988 a 1991 31600-MR1-003 Honda VT C 600 de 1988 a 1989 31600-MR1-010 Honda VT C / CD 600 de 1988 a 2007 31600-MY0-771 Honda VT Nighthawk GT 650 31600-MY0-771 Honda VT Revere 650 31600-MY0-771
产品单重	340克			
检测程序	M325			
电线插头	黄1.5 X 25CM			
内盒尺寸	12*9.5*6CM			
外箱尺寸	49.5*25.5*30.5CM			
输出电压	14.5±0.5V 25安培			
一箱只数	50			
铝壳尺寸				
重要说明				
产品编号	R2003.7		 <p>1. GND / Masa 2. Battery (+) / Bateria (+)</p> <p>4. Power Coil / Bobina de Carga 5. Power Coil / Bobina de Carga 6. Power Coil / Bobina de Carga</p>	Mercury 75-90 H 4 stroke/ Mercury 804278A12 sign II Yamaha 75-80-90-100 H N: 67F-81960-12-00 CROSS REFERENCE: 67F-81960-00-00, 67F-81960-11-00, 67F-81960-12-00, 804278A12, 804278T11 Manufacturer N: 67F-81960-12-00 Internal Co : F81960
产品单重	310克			
检测程序	325			
电线插头	25CM			
内盒尺寸	12*9.5*6CM			
外箱尺寸	49.5*25.5*30.5CM			
输出电压	14.5±0.5V			
一箱只数	50			
铝壳尺寸				
重要说明	要黑色插头			
产品编号	R2003.7.1		 <p>1. GND / Masa 2. Battery (+) / Bateria (+)</p> <p>4. Power Coil / Bobina de Carga 5. Power Coil / Bobina de Carga 6. Power Coil / Bobina de Carga</p>	804278A12 OEM 67F-81960-12-00 Mercury 75-90 H 4 stroke/ Mercury 804278A12 sign II / - Yamaha 75-80-90-100 H N: 67F-81960-12 Cross Reference: 67F-81960-00-00, 67F-81960-11-00, , 804278T11 Manufacturer N: 67F-81960-12 Internal Co : F81960
产品单重	310克			
检测程序	325			
电线插头	25CM			
内盒尺寸	12*9.5*6CM			
外箱尺寸	49.5*25.5*30.5CM			
输出电压	14.5±0.5V			
一箱只数	50			
铝壳尺寸				
重要说明	要黄色插头			

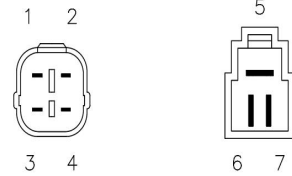

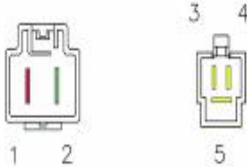

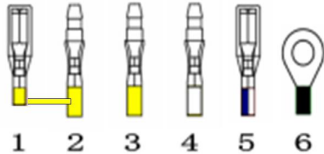

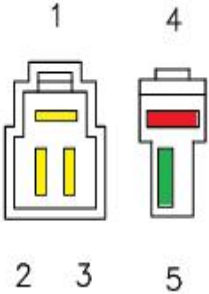
产品资料1		实物主图	接口图	适用范围
产品编号	R2003.7.2		 <p>1. GND / Masa 2. Battery (+) / Bateria (+) 3. Battery (+) / Bateria (+) 4. Power Coil / Bobina de Carga 5. Power Coil / Bobina de Carga 6. Power Coil / Bobina de Carga</p>	shore ower Trim / Tilt Electric 20 In. 115 1998-1999 Yamaha C-TLR ower Trim / Tilt Electric 20 In. 115 2000 Yamaha C-TXR ower Trim / Tilt Electric Remote 25 In. 115 2000 Yamaha ETL 20 In. 115 1990 Yamaha ETL-JD Jet 20 In. 115 1990 Yamaha ETX 25 In. 115 1990 Yamaha -TLR ower Trim / Tilt Electric Remote 20 In. 115 1993-1996
产品单重	310克			
检测程序	325			
电线插头	15和25CM 负极黑线1.5平方的			
内盒尺寸	12*9.5*6CM			
外箱尺寸	49.5*25.5*30.5CM			
输出电压	14.5±0.5V			
一箱只数	50			
铝壳尺寸				
重要说明	3绿交流 2红正1黑负			
产品编号	R2003.8		 <p>1. Battery (+) / Bateria (+) 2. GND / Masa 3. Power Coil / Bobina de Carga 4. Power Coil / Bobina de Carga 5. Power Coil / Bobina de Carga 6. Field Coil / Bobina de Campo 7. Ignition Switch / Sensor</p>	2330 25A CAM 0 + Honda CB F 400 1976 1978 31400-333-004 Honda CB F 350 1972 1975 Honda CB K 500 1971 1973 Honda CB F Super Sport 550 1975 1977 31400-300-035 Honda CB Hondamatic 750 1976 1978 31400-300-035 Honda CB F Super Sport SOHC 750 1975 1978 31400-300-035
产品单重	310克			
检测程序	CB750+励磁 2330			
电线插头	25CM			
内盒尺寸	12*9.5*6CM			
外箱尺寸	49.5*25.5*30.5CM			
输出电压	14.5±0.5V 25安培			
一箱只数	50			
铝壳尺寸				
重要说明				
产品编号	R2003.9		 <p>1. Battery (+) / Bateria (+) 2. Ignition Switch / Sensor 3. GND / Masa 4. Battery (+) / Bateria (+) 5. Power Coil / Bobina de Carga 6. GND / Masa 7. Power Coil / Bobina de Carga 8. Power Coil / Bobina de Carga</p>	2337 35A Honda GL L Goldwing 1200 1985 31600-MG9-951 Honda GL SEI Goldwing 1200 1986 31600-ML8-305
产品单重	310克			
检测程序	325 2337			
电线插头	黄1.5 X 25CM			
内盒尺寸	12*9.5*6CM			
外箱尺寸	49.5*25.5*30.5CM			
输出电压	14.5±0.5V 35安培			
一箱只数	50			
铝壳尺寸				
重要说明				
产品编号	R2003.10		 <p>1. Battery (+) / Bateria (+) 2. Ignition Switch / Sensor 3. GND / Masa 4. Battery (+) / Bateria (+) 5. Power Coil / Bobina de Carga 6. GND / Masa 7. Power Coil / Bobina de Carga 8. Power Coil / Bobina de Carga</p>	本田佛沙250 03款 8线的
产品单重	310克			
检测程序	325			
电线插头	黄1.5 X 25CM			
内盒尺寸	12*9.5*6CM			
外箱尺寸	49.5*25.5*30.5CM			
输出电压	14.5±0.5V			
一箱只数	50			
铝壳尺寸				
重要说明	5 6 7 是交流黄线			

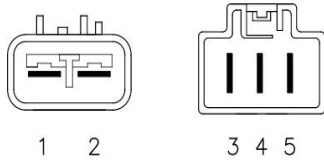

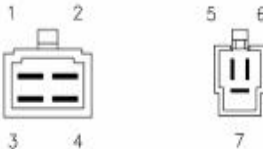

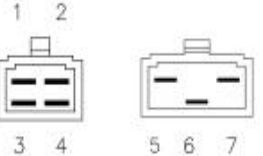

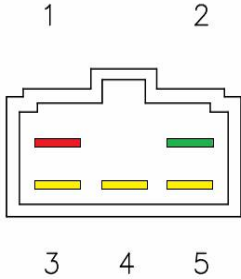
产品资料1		实物主图	接口图	适用范围
产品编号	R2003.11		 <ol style="list-style-type: none"> 1. Battery (+) / Batería (+) 2. GND / Masa 3. Power Coil / Bobina de Carga 4. Power Coil / Bobina de Carga 5. Power Coil / Bobina de Carga 	68V-81960-10-00 Yamaha F50 2011-2017 Yamaha F60 2011-2017 Yamaha F70 2010-2017 Yamaha F115 2007-2013 Yamaha FL115 2006-2013 Yamaha FT50 2011-2017 Yamaha FT60 2011-2017
产品单重	310克			
检测程序	325			
电线插头	7CM 6针插头/只用5 针			
内盒尺寸	12*9.5*6CM			
外箱尺寸	49.5*25.5*30.5CM			
输出电压	14.5±0.5V			
一箱只数	50			
铝壳尺寸				
重要说明				
产品编号	R2003.11A		 <ol style="list-style-type: none"> 1. Battery (+) / Batería (+) 2. GND / Masa 3. Power Coil / Bobina de Carga 4. Power Coil / Bobina de Carga 5. Power Coil / Bobina de Carga 	68V-81960-10-00 Yamaha 50-70 / 115 H 4-Stroke 2006 and Newer F50, F60, F70, F115, LF115, T50, T60 Four- Stroke Outboard
产品单重	310克			
检测程序	325			
电线插头	25CM 6针插头/只用5 针			
内盒尺寸	12*9.5*6CM			
外箱尺寸	49.5*25.5*30.5CM			
输出电压	14.5±0.5V			
一箱只数	50			
铝壳尺寸				
重要说明				
产品编号	R2003.11B		 <ol style="list-style-type: none"> 1. Battery (+) / Batería (+) 2. GND / Masa 3. Power Coil / Bobina de Carga 4. Power Coil / Bobina de Carga 5. Power Coil / Bobina de Carga 	68V-81960-10-00 Yamaha F50 2011-2017 Yamaha F60 2011-2017 Yamaha F70 2010-2017 Yamaha F115 2007-2013 Yamaha FL115 2006-2013 Yamaha FT50 2011-2017 Yamaha FT60 2011-2017
产品单重	310克			
检测程序	325			
电线插头	25CM 6针插头			
内盒尺寸	12*9.5*6CM			
外箱尺寸	49.5*25.5*30.5CM			
输出电压	14.5±0.5V			
一箱只数	50			
铝壳尺寸				
重要说明				
产品编号	R2003.11Y		 <ol style="list-style-type: none"> 1. Battery (+) / Batería (+) 2. GND / Masa 3. Power Coil / Bobina de Carga 4. Power Coil / Bobina de Carga 5. Power Coil / Bobina de Carga 	68V-81960-10-00 Yamaha F50 2011-2017 Yamaha F60 2011-2017 Yamaha F70 2010-2017 Yamaha F115 2007-2013 Yamaha FL115 2006-2013 Yamaha FT50 2011-2017 Yamaha FT60 2011-2017
产品单重	310克			
检测程序	325			
电线插头	7CM 6针插头			
内盒尺寸	12*9.5*6CM			
外箱尺寸	49.5*25.5*30.5CM			
输出电压	14.5±0.5V			
一箱只数	50			
铝壳尺寸				
重要说明				

产品资料1		实物主图	接口图	适用范围
产品编号	R2003.12		1. Battery (+) / Bateria (+) 红线 2. GND / Masa 绿线 3. Power Coil / Bobina de Carga 黄线 4. Power Coil / Bobina de Carga 黄线 5. Power Coil / Bobina de Carga 黄线 6. Field Coil / Bobina de Campo 白线 7. Ignition Switch / Sensor 黑线	Honda CB350F CB400F CB500 CB550 CB750
产品单重	310克			
检测程序	CB750			
电线插头	黄1.5 X 30CM			
内盒尺寸	12*9.5*6CM			
外箱尺寸	49.5*25.5*30.5CM			
输出电压	14.5±0.5V			
一箱只数	50			
铝壳尺寸				
重要说明				
产品编号	R2003.13		 1. Battery (+) / Bateria (+) 2. GND / Masa 3. Power Coil / Bobina de Carga 4. Power Coil / Bobina de Carga 5. Power Coil / Bobina de Carga	Suzuki AN Burgman 650 2006 2011 32800-10G30 Suzuki VZR Intruder 1800 2006 2012 32800-10G30
产品单重	310克			
检测程序	M325 2597			
电线插头	所有1.5 X 30CM			
内盒尺寸	12*9.5*6CM			
外箱尺寸	49.5*25.5*30.5CM			
输出电压	14.5±0.5V 50安培			
一箱只数	50			
铝壳尺寸				
重要说明				
产品编号	R2003.14		 1. Ignition Switch / Sensor 2. Battery (+) / Bateria (+) 3. GND / Masa 4. Power Coil / Bobina de Carga 5. Power Coil / Bobina de Carga 6. Power Coil / Bobina de Carga	Marca Mo lo Versión Cilindrada Año Cod. OEM Yamaha YFM Grizzly 300 2012 2013 ISC-H1960-00-00 Yamaha YFM Grizzly 300 2012 2013 ISC-H1960-01-00
产品单重	310克			
检测程序	M325			
电线插头	25CM			
内盒尺寸	12*9.5*6CM			
外箱尺寸	49.5*25.5*30.5CM			
输出电压	14.5±0.5V			
一箱只数	50			
铝壳尺寸				
重要说明				
产品编号	R2003.15		 1. GND / Masa 2. Battery (+) / Bateria (+) 3. Power Coil / Bobina de Carga 4. Power Coil / Bobina de Carga 5. Power Coil / Bobina de Carga	515176100 515175968 515175756 Ski-doo MX Z 500 SS Trail Carb L/C 2004-2005, 2007 Ski-doo MX Z 800 HO Renega Carb L/C 2004-2005, 2007 Ski-doo MX Z 600 HO Adrenaline Carb L/C 2003-2007 Ski-doo MX Z 800 HO Adrenaline Carb L/C 2004-2005, 2007 Ski-doo MX ZX 600 HO Carb L/C 2003-2005
产品单重	310克			
检测程序	M325			
电线插头	所有1.5 X 20CM			
内盒尺寸	12*9.5*6CM			
外箱尺寸	49.5*25.5*30.5CM			
输出电压	14.5±0.5V			
一箱只数	50			
铝壳尺寸				
重要说明				

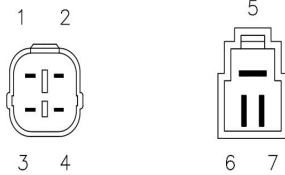

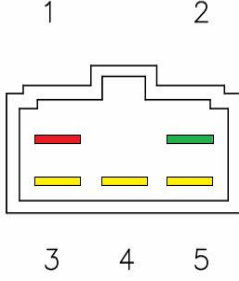

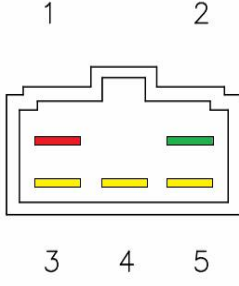

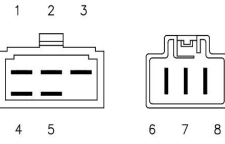
产品资料1		实物主图	接口图	适用范围
产品编号	R2003.16		 <p>1. Battery (+) / Bateria (+) 2. Ignition Switch / Sensor 3. GND / Masa 4. Battery (+) / Bateria (+) 5. GND / Masa 6. Power Coil / Bobina de Carga 7. Power Coil / Bobina de Carga 8. Power Coil / Bobina de Carga</p>	Suzuki Cavalca 1400 GV1400GT 1996-1998
产品单重	310克			
检测程序	M325			
电线插头	5 25CM			
内盒尺寸	12*9.5*6CM			
外箱尺寸	49.5*25.5*30.5CM			
输出电压	14.5±0.5V			
一箱只数	50			
铝壳尺寸				
重要说明				
产品编号	R2003.17			32800-48H00 Suzuki GW250 Inazuma 2014-2017 Suzuki GW250 MAGNETO 2014-2017
产品单重	310克			
检测程序	M325			
电线插头	所有1.5 X 25CM			
内盒尺寸	12*9.5*6CM			
外箱尺寸	49.5*25.5*30.5CM			
输出电压	14.5±0.5V			
一箱只数	50			
铝壳尺寸				
重要说明				
产品编号	R2003.18		 <p>1. Battery (+) / Bateria (+) 2. Ignition Switch / Sensor 3. GND / Masa 4. Power Coil / Bobina de Carga 5. Power Coil / Bobina de Carga 6. Power Coil / Bobina de Carga</p>	1997 - 2005 ER500 ER-5 1994 - 1995 ZR400 Ze hydr 1996 - 2008 ZR400 Ze hydr X 1994 - 1998 ZR550 Ze hydr 21066-1098 21066-1030 Kawasaki Kawasaki kle400 en500 ex250r g x250 g z400 EL250E Eliminator 250 EX250 Ninja EX500 Ninja EN500 Vulcan EN450 454 LTD EN500 Vulcan KZ1100A ZX750E G Z 750 KZ1100 KZ550C LTD KZ750F1 LTD KZ550C KZ1000K Z750N S ectre a p r.
产品单重	310克			
检测程序	M325			
电线插头	35CM			
内盒尺寸	12*9.5*6CM			
外箱尺寸	49.5*25.5*30.5CM			
输出电压	14.5±0.5V			
一箱只数	50			
铝壳尺寸				
重要说明				
产品编号	R2003.19		 <p>1. Battery (+) / Bateria (+) 2. Battery (+) / Bateria (+) 3. GND / Masa 4. GND / Masa 5. Power Coil / Bobina de Carga 6. Power Coil / Bobina de Carga 7. Power Coil / Bobina de Carga</p>	2440 Suzuki LT-A KingQuad 700 2005 2007 32800-41F10
产品单重	310克			
检测程序	M325 2440			
电线插头	黑1.5 X 25CM			
内盒尺寸	12*9.5*6CM			
外箱尺寸	49.5*25.5*30.5CM			
输出电压	14.5±0.5V 50安培			
一箱只数	50			
铝壳尺寸				
重要说明	3黑线交流 2黑红线2 黑白线			

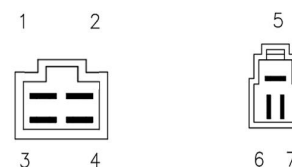

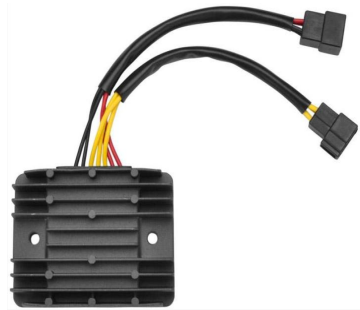
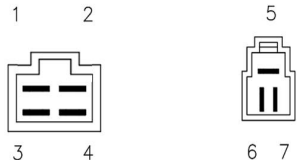

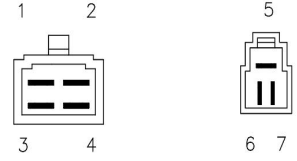

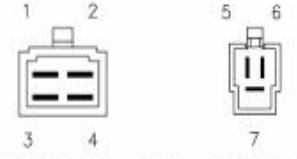
产品资料1		实物主图	接口图	适用范围
产品编号	R2003.20		 <p>1. Battery (+) / Bateria (+) 2. GND / Masa 3. Power Coil / Bobina de Carga 4. Power Coil / Bobina de Carga 5. Power Coil / Bobina de Carga</p>	SH678FE SH678-FE TRIFASE 5CAVI HONDA 125 XLV Varadero 2007-2011 Honda XL 125 V7 Varadero 07 SH678-FE
产品单重	310克			
检测程序	M325			
电线插头	黄1.5 X 55 红绿线90CM			
内盒尺寸	12*9.5*6CM			
外箱尺寸	49.5*25.5*30.5CM			
输出电压	14.5±0.5V 35安培			
一箱只数	50			
铝壳尺寸				
重要说明	1个大套管 再 接一个小套管			
产品编号	R2003.21		 <p>1. AC Power Coil 1是AC输出 2. AC Power Coil 3. AC Power Coil 4. Battery (+) 5. Battery (+) 6. Battery (-)</p>	Honda 31600-ZV5-003 SH598C-12 860-437-0060 Honda 35 hp BF35AM Honda 40 hp BF40B Honda 40 hp BF40B2 Honda 40 hp BF40BX Honda 40 hp BF40A4 Honda 40 hp BF40A Honda 40 hp BF40A2 Honda 40 hp BF40A1 Honda 40 hp BF40AX
产品单重	310克			
检测程序	QF2101 新			
电线插头	负极15 白线25黄线和黑白线45CM			
内盒尺寸	12*9.5*6CM			
外箱尺寸	49.5*25.5*30.5CM			
输出电压	14.5±0.5V			
一箱只数	50			
铝壳尺寸	1 号线应该是交流输出			
重要说明	黑白线是指示灯线,白线正 黑线负			
产品编号	R2003.22		 <p>1. Power Coil 2. Power Coil 3. Power Coil 4. Battery (+) 5. Battery (-)</p>	21066-1093 Kawasaki KLX250 1994-1995/1998-2007 Kawasaki KLX250 D-Tracker 1998-2007 Kawasaki KLX250ES 1994-1997 Kawasaki KLX250SR 1993-1997 Kawasaki KLX300R KLX300-B 1997-1999 SH530-12
产品单重	净重 350克			
检测程序	M325			
电线插头	75CM 1.5平方			
内盒尺寸	12*9.5*6CM			
外箱尺寸	49.5*25.5*30.5CM			
输出电压	14.5±0.5V			
一箱只数	50			
铝壳尺寸				
重要说明				
产品编号	R2003.23		 <p>1. Battery (+) / Bateria (+) 2. GND / Masa 3. Power Coil / Bobina de Carga 4. Power Coil / Bobina de Carga 5. Power Coil / Bobina de Carga</p>	SUZUKI AN 650
产品单重	净重 400克			
检测程序	M325			
电线插头	40CM 进口高温线3平方			
内盒尺寸	12*9.5*6CM			
外箱尺寸	49.5*25.5*30.5CM			
输出电压	14.5±0.5V			
一箱只数	50			
铝壳尺寸				
重要说明				

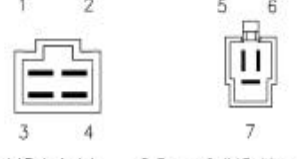

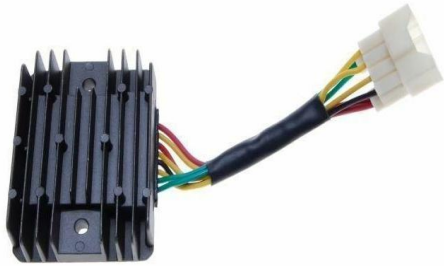
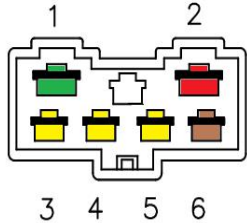

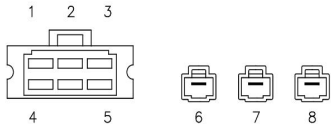
产品资料1		实物主图	接口图	适用范围
产品编号	R2003A.1		 <p>1. Battery (+) / Bateria (+) 2. GND / Masa 3. Battery (+) / Bateria (+) 4. GND / Masa 5. Power Coil / Bobina de Carga 6. Power Coil / Bobina de Carga 7. Power Coil / Bobina de Carga</p>	Honda VF V45 Magna 750 1987 1988 31600-MN0-008 SH593A-12 Honda VF 700 + 750 Su ermagna (VF700 VF750 RC21 RC28 Honda CBR500F (1987 1989-1991), CBR600F Hurricane (1987-1990), VTR250 VTR (1988-1990), VFR700F Interce tor (1986), VFR700F2 Interce tor (1986), VF700C Magna (1987), VF750C Magna V45 (1988), NTV600 Revere (1989), NTV650 Revere (1989 1995-1997), VF750C Magna
产品单重	250克			
检测程序	M325			
电线插头	20 35CM			
内盒尺寸	12*9.5*6CM			
外箱尺寸	49.5*25.5*30.5CM			
输出电压	14.5±0.5V			
一箱只数	50			
铝壳尺寸				
重要说明	铝壳有斜角			
产品编号	R2003A.2		 <p>1. Battery (+) / Bateria (+) 2. GND / Masa 3. Battery (+) / Bateria (+) 4. GND / Masa 5. Power Coil / Bobina de Carga 6. Power Coil / Bobina de Carga 7. Power Coil / Bobina de Carga</p>	Honda CB Su er Four 1300 1998 2002 31600-MBR-000 Honda CBR F 600 1987 1988 31600- MN4-008 Honda CBR F 600 1987 1990 31600- MN4-018 Honda CBR R 400 1986 1987 31600- KT8-013 Honda NTV Revere 650 1988 1997 31600-MS9-003 Honda VF C 750 1994 2003 31600-MZ5-
产品单重	净重320克, 盒重345克			
检测程序	M325			
电线插头	20 35CM			
内盒尺寸	12*9.5*6CM			
外箱尺寸	49.5*25.5*30.5CM			
输出电压	14.5			
一箱只数	50			
铝壳尺寸				
重要说明	铝壳有斜角			
产品编号	R2003A.3		 <p>1. Battery (+) 2. GND 3. Power Coil 4. Power Coil 5. Power Coil</p>	V834400126 5SL-81960-00-00 YAMAHA 600 XJ N 2009-2011 Yamaha R6 5SL SH713AA 5SL-81960-00 1WD-H1960-00
产品单重	250克			
检测程序	M325			
电线插头	5针插头			
内盒尺寸	12*9.5*6CM			
外箱尺寸	49.5*25.5*30.5CM			
输出电压	14.5±0.5V			
一箱只数	50			
铝壳尺寸				
重要说明	铝壳有斜角			
产品编号	R2003A.4			Honda CBR500F (1987 1989-1991), CBR600F Hurricane (1987-1990), VTR250 VTR (1988-1990), VFR700F Interce tor (1986), VFR700F2 Interce tor (1986), VF700C Magna (1987), VF750C Magna V45 (1988), NTV600 Revere (1989), NTV650 Revere (1989 1995-1997), VF750C Magna (1993-2003) a p r.: 31600-MN4-018 31600MN4018 31600-KT8-013 31600KT8013 31600-MBR-
产品单重	250克			
检测程序	M325			
电线插头	45CM			
内盒尺寸	12*9.5*6CM			
外箱尺寸	49.5*25.5*30.5CM			
输出电压	14.5±0.5V			
一箱只数	50			
铝壳尺寸				
重要说明	铝壳有斜角			

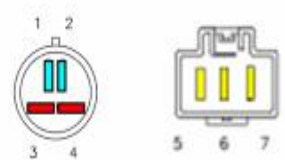
产品资料1		实物主图	接口图	适用范围
产品编号	R2004.0		 <p>1. Battery (+) / Bateria (+) 2. Battery (+) / Bateria (+) 3. GND / Masa 4. GND / Masa 5. Power Coil / Bobina de Carga 6. Power Coil / Bobina de Carga 7. Power Coil / Bobina de Carga</p>	2440 Suzuki LT-A KingQuad 700 2005 2007 32800-41F10 2452 Suzuki DL V-Strom 650 2007 2012 32800-41G00 Suzuki DL 650 2013 2017 32800-47H10 Suzuki GSF Bandit 1250 2007 2009 32800-18H00 Suzuki GSF SA 1250 2016 32800-41G10 Suzuki GSF Bandit 650 2007 2010
产品单重	310克			
检测程序	M325 2440 2452			
电线插头	黑1.5 X 25CM			
内盒尺寸	12*9.5*6CM			
外箱尺寸	49.5*25.5*30.5CM			
输出电压	14.5±0.5V 50安培			
一箱只数	50			
铝壳尺寸				
重要说明	3黑线交流 2黑红线2 黑白线			
产品编号	R2004.1		 <p>1. Battery (+) 2. GND 3. Power Coil 4. Power Coil 5. Power Coil</p>	2312 Reem lazo Kokusan nki RS41-29 Suzuki - 32800-33E21 Suzuki GSX R 600 2001 2005 32800-33E20 Suzuki GSX R 750 1998 2005 32800-33E20 Suzuki GSX R 1000 2001 2004 32800-33E20 Suzuki GSX R 600 1997 2000 32800-33E00
产品单重	300克			
检测程序	M325 2312			
电线插头	1.5 黑X 25CM			
内盒尺寸	12*9.5*6CM			
外箱尺寸	49.5*25.5*30.5CM			
输出电压	14.5±0.5V 35安培			
一箱只数	50			
铝壳尺寸				
重要说明				
产品编号	R2004.1A		 <p>1. Battery (+) 2. GND 3. Power Coil 4. Power Coil 5. Power Coil</p>	2312 Reem lazo Kokusan nki RS41-29 Suzuki - 32800-33E21 Suzuki GSX R 600 2001 2005 32800-33E20 Suzuki GSX R 750 1998 2005 32800-33E20 Suzuki GSX R 1000 2001 2004 32800-33E20 Suzuki GSX R 600 1997 2000 32800-33E00
产品单重	盒重350克，净重325克			
检测程序	M325 2312			
电线插头	1.5 黑X 25CM			
内盒尺寸	12*9.5*6CM			
外箱尺寸	49.5*25.5*30.5CM			
输出电压	14.5±0.5V 35安培			
一箱只数	50			
铝壳尺寸				
重要说明	双红线（双绿线）打在一个铜片上			
产品编号	R2004.2		 <p>1. Battery (+) / Bateria (+) 2. GND / Masa 3. Ignition Switch / Sensor 4. Battery (+) / Bateria (+) 5. GND / Masa 6. Power Coil / Bobina de Carga 7. Power Coil / Bobina de Carga 8. Power Coil / Bobina de Carga</p>	Honda CBR 1100 1999 2000 31600-MAT-E01 Honda CBR XX Blackbird 1100 1999 2000 31600-MAT-E01 Reem lazo Shin ngen SH579C-12
产品单重	310克			
检测程序	M325			
电线插头	黄1.5 X 45CM			
内盒尺寸	12*9.5*6CM			
外箱尺寸	49.5*25.5*30.5CM			
输出电压	14.5±0.5V			
一箱只数	50			
铝壳尺寸				
重要说明	3黄线交流2红正2绿负1黑线检测			

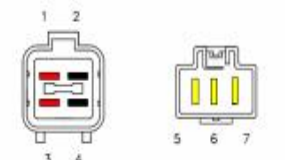
产品资料1		实物主图	接口图	适用范围
产品编号	R2004.2.1		 <p>1. Battery (+) 2. GND 3. Battery (+) 4. GND 5. Power Coil 6. Power Coil 7. Power Coil</p>	Honda CB919 CB 900 F2/F3/F4/F5/F6/F7 Hornet 2002-2007 Aprilia Mana 850 2008-2009 Honda VTX 1300 S3/S4/S5/S6 2003~2009
产品单重	310克			
检测程序	M325			
电线插头	黄1.5 X 50CM			
内盒尺寸	12*9.5*6CM			
外箱尺寸	49.5*25.5*30.5CM			
输出电压	14.5±0.5V			
一箱只数	50			
铝壳尺寸				
重要说明	3黄线交流2红正2绿负			
产品编号	R2004.2.2		 <p>1. Battery (+) / Bateria (+) 2. Battery (+) / Bateria (+) 3. Power Coil / Bobina de Carga 4. GND / Masa 5. GND / Masa 6. Ignition Switch / Sensor 7. Power Coil / Bobina de Carga 8. Power Coil / Bobina de Carga 9. Power Coil / Bobina de Carga</p>	Kawasaki 21066-1126 Kawasaki VN1500R Drifter VNT50JR 2001 Kawasaki VN1500R Drifter VNT50JR 2002- 2003 Kawasaki VN1500 Mean Streak VNT50 2002 Kawasaki VN1500 Mean Streak VNT50 2003 Kawasaki VN1600B Mean Streak VNT60B 2004 Kawasaki VN1600B Mean Streak VNT60B
产品单重	净重368 盒重390克			
检测程序	M325 2457			
电线插头	黄1.5 X 35CM			
内盒尺寸	12*9.5*6CM			
外箱尺寸	49.5*25.5*30.5CM			
输出电压	14.5±0.5V MOSFET 35安培			
一箱只数	50			
铝壳尺寸				
重要说明	4黄线交流2红正2黑负1棕线检测			
产品编号	R2004.3		 <p>1. Battery (+) / Bateria (+) 2. GND / Masa 3. Battery (+) / Bateria (+) 4. GND / Masa 5. Power Coil / Bobina de Carga 6. Power Coil / Bobina de Carga 7. Power Coil / Bobina de Carga</p>	2551 35A Ducati -54040261A Ducati -54040101A Ducati -54040111A Ducati -54040131A Ducati Hy ermotard EVO 1100 2010 2012 54040111C Ducati Hy ermotard796 2010 2012 54040111C Ducati Hy ermotard1100 2011 2012 54040111C
产品单重	320克			
检测程序	M325 2551 2509			
电线插头	黄1.5 X 25CM			
内盒尺寸	12*9.5*6CM			
外箱尺寸	49.5*25.5*30.5CM			
输出电压	14.5±0.5V 35安培			
一箱只数	50			
铝壳尺寸				
重要说明				
产品编号	R2004.6		 <p>1. Battery (+) / Bateria (+) 2. GND / Masa 3. Battery (+) / Bateria (+) 4. GND / Masa 5. Power Coil / Bobina de Carga 6. Power Coil / Bobina de Carga 7. Power Coil / Bobina de Carga</p>	YHC041 杜卡迪Ducati ST4S 996 01-05 Ducati 916 S4 Monster 01-03 Ducati 996 S4R Monster 04-06 Ducati Monster 1000 S4R 07-08 Ducati Monster 1000 S2R 06-08 Ducati Monster 600 Metallic 00-01 Ducati Monster 1000 ie 03-05 Ducati S 750 ie 01-02 Ducati Monster 796 ABS 10-12 Ducati ort folio 1100 S 07-08
产品单重	310克			
检测程序	M325			
电线插头	黄1.5 X 20CM			
内盒尺寸	12*9.5*6CM			
外箱尺寸	49.5*25.5*30.5CM			
输出电压	14.5±0.5V			
一箱只数	50			
套管情况	一条套管			
重要说明				



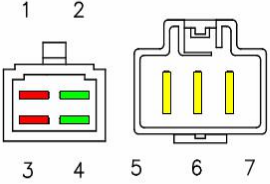
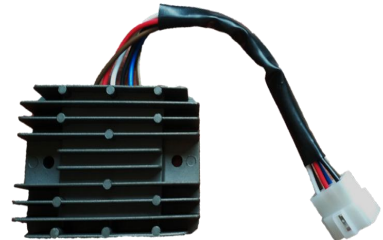
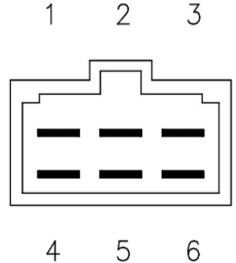

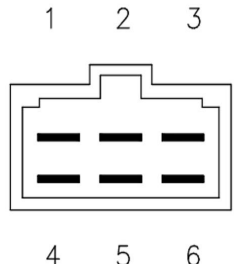

产品资料1		实物主图	接口图	适用范围
产品编号	R2004.6A		 <p>1. Battery (+) / Bateria (+) 2. GND / Masa 3. Battery (+) / Bateria (+) 4. GND / Masa</p> <p>5. Power Coil / Bobina de Carga 6. Power Coil / Bobina de Carga 7. Power Coil / Bobina de Carga</p>	TRIUMPH STREET TRIPLE 675 R675 2009 2010 2011 TRIUMPH STREET TRIPLE 675 2009 2010 TRIUMPH STREET TRIPLE R 675 2010 2011 TRIUMPH DAYTONA 955 T595 955i 1997 1998 1999 2000 2001 2002 2003 2004 2005 2006 TRIUMPH DAYTONA 600 2004 TRIUMPH DAYTONA 650 2005 TRIUMPH TIGER 955 2001 2002 2003 2004 2005 2006
产品单重	310克			
检测程序	M325			
电线插头	黄1.5 X 26CM			
内盒尺寸	12*9.5*6CM			
外箱尺寸	49.5*25.5*30.5CM			
输出电压	14.5±0.5V			
一箱只数	50			
套管情况	2条套管			
重要说明				
产品编号	R2004.7		 <p>1. Battery (+) / Bateria (+) 2. GND / Masa 3. Battery (+) / Bateria (+) 4. GND / Masa</p> <p>5. Power Coil / Bobina de Carga 6. Power Coil / Bobina de Carga 7. Power Coil / Bobina de Carga</p>	Ducati 54040191A Ducati 1098 Bi osto/Mono osto 2007-2008 Ducati 1098 S Bi osto/Mono osto 2007-2008 Ducati 1198 R 2008-2009 Ducati 1198 S 2009-2010 Ducati 1198 2009-2011 Ducati 1198 S 2011 Ducati 1198 R Corse 2010 Ducati 11198 S Corse 2010
产品单重	310克			
检测程序	M325			
电线插头	黄1.5 X 15 25CM			
内盒尺寸	12*9.5*6CM			
外箱尺寸	49.5*25.5*30.5CM			
输出电压	14.5±0.5V			
一箱只数	50			
铝壳尺寸				
重要说明				
产品编号	R2004.7.1		 <p>1. Battery (+) / Bateria (+) 2. GND / Masa 3. Battery (+) / Bateria (+) 4. GND / Masa</p> <p>5. Power Coil / Bobina de Carga 6. Power Coil / Bobina de Carga 7. Power Coil / Bobina de Carga</p>	SH579A-12 Suzuki TL1000R 1998-2003 Suzuki TL1000S 1997-2001
产品单重	310克			
检测程序	M325			
电线插头	黑1.5 X 25CM			
内盒尺寸	12*9.5*6CM			
外箱尺寸	49.5*25.5*30.5CM			
输出电压	14.5±0.5V			
一箱只数	50			
铝壳尺寸				
重要说明	3黑线交流 2黑红线2 黑白线			
产品编号	R2004.7.2		 <p>1. Battery (+) / Bateria (+) 2. GND / Masa 3. Battery (+) / Bateria (+) 4. GND / Masa</p> <p>5. Power Coil / Bobina de Carga 6. Power Coil / Bobina de Carga 7. Power Coil / Bobina de Carga</p>	Suzuki DL1000 (V-Strom) DL1000 2002-2012
产品单重	310克			
检测程序	M325			
电线插头	黑1.5 X 25CM			
内盒尺寸	12*9.5*6CM			
外箱尺寸	49.5*25.5*30.5CM			
输出电压	14.5±0.5V			
一箱只数	50			
铝壳尺寸				
重要说明				



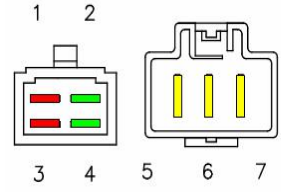

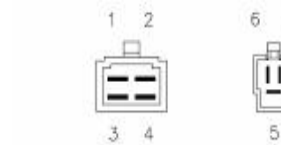

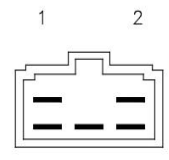
产品资料1		实物主图	接口图	适用范围
产品编号	R2004.8		 <p>1. GND 2. Battery (+) 3. Power Coil 4. Power Coil 5. Power Coil 6. Ignition Switch</p>	Kawasaki ZX-9R ZX900CC 1998-1999 21066-2079
产品单重	345克总重			
检测程序	M325 2624			
电线插头	黄红绿1.5 X 15CM			
内盒尺寸	12*9.5*6CM			
外箱尺寸	49.5*25.5*30.5CM			
输出电压	14.5±0.5V 35			
一箱只数	50			
铝壳尺寸				
重要说明	双红线 双绿线			
产品编号	R2004.9		 <p>1. Battery (+) / Bateria (+) 2. Ignition Switch / Sensor 3. GND / Masa 4. Battery (+) / Bateria (+) 5. GND / Masa 6. Power Coil / Bobina de Carga 7. Power Coil / Bobina de Carga 8. Power Coil / Bobina de Carga</p>	2334 35A Reem lazo Shin ngen SH576-12 [38A] Suzuki VS Intru r 700 1985 1987 32800-38A00 Suzuki VS Intru r 750 1988 1991 32800-38A00 Suzuki VS Intru r 800 1992 1997 32800-38A00
产品单重	310克			
检测程序	M325			
电线插头	黄1.5 X 10 30CM			
内盒尺寸	12*9.5*6CM			
外箱尺寸	49.5*25.5*30.5CM			
输出电压	14.5±0.5V			
一箱只数	50			
铝壳尺寸				
重要说明				
产品编号	R2004.10		 <p>1. Battery (+) / Bateria (+) 2. Battery (+) / Bateria (+) 3. GND / Masa 4. GND / Masa 5. Power Coil / Bobina de Carga 6. Power Coil / Bobina de Carga 7. Power Coil / Bobina de Carga</p>	小R 大R K6 K7 K8 小R600 750 1000 铃木 大排整流器 Voltage Regulator Rectifier Suzuki AN400 BURGMAN 400 SKYWAVE 400 2007-2011 Suzuki BURGMAN 400 SKYWAVE 400 AN400
产品单重	克			
检测程序	M325			
电线插头	黑1.5 X 25CM			
内盒尺寸	100*85*30MM			
外箱尺寸	49.5*25.5*30.5CM			
输出电压	14.5±0.5V			
一箱只数	50			
铝壳尺寸				
重要说明	要黑色4 插			
产品编号	R2004.11		 <p>1. Battery (+) / Bateria (+) 2. GND / Masa 3. Battery (+) / Bateria (+) 4. GND / Masa 5. Power Coil / Bobina de Carga 6. Power Coil / Bobina de Carga 7. Power Coil / Bobina de Carga</p>	小R 大R K6 K7 K8 小R600 750 1000 铃木 大排整流器 SUZUKI AN400 Burgman 2011 - 2012
产品单重	310			
检测程序	M325			
电线插头	黑1.5 X 30CM			
内盒尺寸	100*85*30MM			
外箱尺寸	49.5*25.5*30.5CM			
输出电压	14.5±0.5V			
一箱只数	50			
铝壳尺寸				
重要说明	3黑线交流 2黑红线 2黑白线			

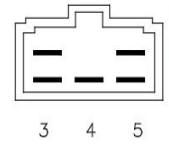

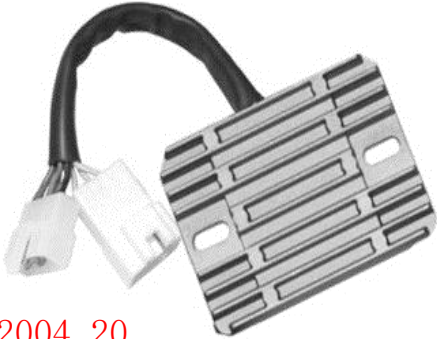
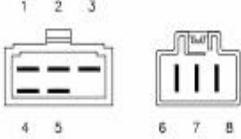

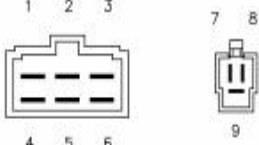

产品资料1		实物主图	接口图	适用范围
产品编号	R2004.12		 <p>1. Battery (+) / Batería (+) 2. GND/ Masa 3. Battery (+) / Batería (+) 4. Ignition Switch / Sensor 5. GND/ Masa 6. Power Coil / Bobina de Carga 7. Power Coil / Bobina de Carga 8. Power Coil / Bobina de Carga</p>	Aprilia RSV TUONO 1000 2006 2009 A 8127144 Aprilia RSV 1000 2004 2008 A 8127144 Reem lazo Shin ngen SH579GA
产品单重	克			
检测程序	M325 2492			
电线插头	黄1.5 X 25CM			
内盒尺寸	100*85*30MM			
外箱尺寸	49.5*25.5*30.5CM			
输出电压	14.5±0.5V 35安培			
一箱只数	50			
铝壳尺寸				
重要说明	3黄线交流 2红线 2绿线 1黑线检测			
产品编号	R2004.13		 <p>1. Battery (+) 2. GND 3. Battery (+) 4. GND 5. Power Coil 6. Power Coil 7. Power Coil</p>	Aprilia B043488 SH579JB Aprilia RSV4 1000 Factory 2011-2017 Aprilia RSV4 R 1000 2011-2015 Aprilia RSV4 RF 1000 2015-2017 Aprilia RSV4 1000 AprC Factory ABS 2013-2014 Aprilia RSV4 1000 AprC R ABS 2013-2014 Aprilia RSV4 1000 Racing Factory L.E 2015-2016 Aprilia RSV4 1000RR 2015-2017
产品单重	克			
检测程序	M325			
电线插头	黄1.5 X 60CM 绿绿20CM			
内盒尺寸	100*85*30MM			
外箱尺寸	49.5*25.5*30.5CM			
输出电压	14.5±0.5V MOSFET 35安培			
一箱只数	50			
铝壳尺寸				
重要说明				
产品编号	R2004.14		 <p>1. Battery (+) 2. Battery (+) 3. GND 4. Power Coil 5. Charge Lamp 6. Power Coil</p>	31620-ZG5-033 (20A) VTK0/K1 8818502 SH711AA Honda engines GCV520U WEE1, GCV530 QEA3, GX240K1, GX240U1, GX240UT1, GX240UT2, GX270, GX270U QAR2, GX270UT QAR2 GX340K1, GX340U1, GX340UT1 QNR2, GX340UT2, GX390K1, GX390U1, GX390UT1 QNR2, GX390UT2 QNR2 GX610, GX610K1, GX610R1, GX610U1, GX620, GX620K1, GX620R1, GX620U1,
产品单重	350克			
检测机码	QF2101 2101.8			
电线插头	20CM			
内盒尺寸	12*9.5*6CM			
外箱尺寸	49.5*25.5*30.5CM			
输出电压	14.5±0.5V			
一箱只数	50			
铝壳尺寸				
重要说明	5号线12\0			
产品编号	R2004.14A		 <p>1. Battery (+) 2. Battery (+) 3. GND 4. Power Coil 5. Charge Lamp 6. Power Coil</p>	32105-Z6L-0001 SH748AA Honda GX620 GX670 31750-Z2E-803 Honda GX270UT2, GX440IU, GX630, GX630R, GX630RH, GX660, GX660R, GX660RH, GX690, GX690R, GX690RH, GXV630R, GXV630RH, GXV660R, GXV660RH, GXV690R, GXV690RH
产品单重	350克 净重313克 对插净重66克			
检测机码	QF2101 2101.8			
电线插头	20CM			
内盒尺寸	12*9.5*6CM			
外箱尺寸	49.5*25.5*30.5CM			
输出电压	14.5±0.5V			
一箱只数	50			
铝壳尺寸				
重要说明	5号线12\0			

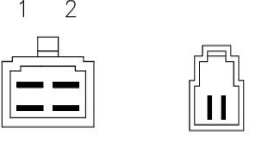

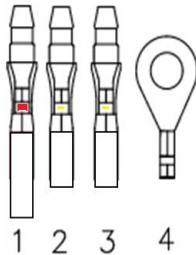

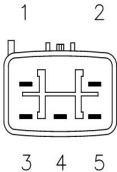

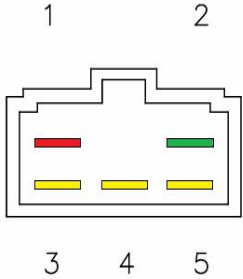
5号线 12\0

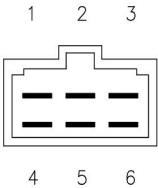

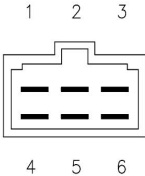

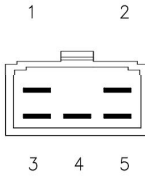

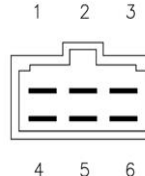
5号线 12\0

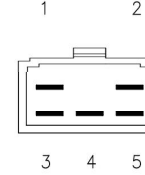
产品资料1		实物主图	接口图	适用范围
产品编号	R2004.15		 <p>1. Battery (+) 2. GND 3. Battery (+) 4. GND 5. Power Coil 6. Power Coil 7. Power Coil</p>	2540 HondaVTXS1300 2003 200431600-MEA-670 HondaVTXC1300200431600-MEA-670 HondaVTXS1300 2005 200931600-MEA-741 HondaVTXR1300 2005 200931600-MEA-741 HondaVTXC1300 2005 200931600-MEA-741 Reem lazoShin ngenSH579DB
产品单重	克			
检测机码	M325 2540			
电线插头	65CM			
内盒尺寸	12*9.5*6CM			
外箱尺寸	49.5*25.5*30.5CM			
输出电压	14.5±0.5V 30安培			
一箱只数	50			
铝壳尺寸				
重要说明				
产品编号	R2004.16		 <p>1. Battery (+) / Bateria (+) 2. GND / Masa 3. Battery (+) / Bateria (+) 4. GND / Masa 5. Power Coil / Bobina de Carga 6. Power Coil / Bobina de Carga 7. Power Coil / Bobina de Carga</p>	2551 Ducati-54040261A Ducati-54040101A Ducati-54040111A Ducati-54040131A DucatiHy ermotardEV01100 2010 2012 54040111C DucatiHy ermotard796 2010 2012 54040111C DucatiHy ermotard1100 2011 2012 54040111C
产品单重	克			
检测机码	M325 2551			
电线插头	25CM			
内盒尺寸	12*9.5*6CM			
外箱尺寸	49.5*25.5*30.5CM			
输出电压	14.5±0.5V 50安培			
一箱只数	50			
铝壳尺寸				
重要说明				
产品编号	R2004.18		 <p>1. Battery (+) / Bateria (+) 2. GND / Masa 3. Battery (+) / Bateria (+) 4. GND / Masa 5. Power Coil / Bobina de Carga 6. Power Coil / Bobina de Carga 7. Power Coil / Bobina de Carga</p>	2571 CagivaNavigator1000 2000 2004 800092586 Reem lazoShin ngenSH579A-12 SuzukiTLR / S1000 1997 200332800-02F00
产品单重	克			
检测机码	M325 2571			
电线插头	20CM			
内盒尺寸	12*9.5*6CM			
外箱尺寸	49.5*25.5*30.5CM			
输出电压	14.5±0.5V 35安培			
一箱只数	50			
铝壳尺寸				
重要说明				
产品编号	R2004.19		 <p>1. Battery (+) / Bateria (+) 2. GND / Masa 3. Power Coil / Bobina de Carga 4. Power Coil / Bobina de Carga 5. Power Coil / Bobina de Carga</p>	2633 Suzuki-32800-33E10 Suzuki-32800-33E20 SuzukiGSXR1000 2001 200432800-33E21 SuzukiGSXR600 2001 200532800-33E21 SuzukiGSXR750 1996 200532800-33E21 SuzukiGSXHayabusa1300 1999 2007 32800-33E21
产品单重	克			
检测机码	M325 2633			
电线插头	20CM			
内盒尺寸	12*9.5*6CM			
外箱尺寸	49.5*25.5*30.5CM			
输出电压	14.5±0.5V 35安培			
一箱只数	50			
铝壳尺寸				
重要说明				

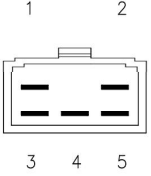

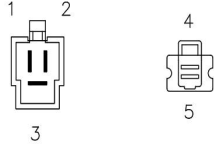
产品资料1		实物主图	接口图	适用范围
产品编号	R2004.20	 <p>R2004.20</p>	 <p>1. Battery (+) / Bateria (+) 2. GND / Masa 3. Ignition Switch / Sensor 4. Battery (+) / Bateria (+) 5. GND / Masa 6. Power Coil / Bobina de Carga 7. Power Coil / Bobina de Carga 8. Power Coil / Bobina de Carga</p> <p>R2004.20</p>	2402 Honda CBR 954 Fireblade 900 2002 2003 31600-MCJ-750 Reem lazo Shin ngen SH678-DA 2403 Honda - 31600-MBG-D00 Honda CBR 1100 1999 2000 31600-MAT-E01 Honda CBR XX Blackbird 1100 1999 2000 31600-MAT-E01 Reem lazo Shin ngen SH579C-12
产品单重	克			
检测机码	M325 2403 2402			
电线插头	25CM			
内盒尺寸	12*9.5*6CM			
外箱尺寸	49.5*25.5*30.5CM			
输出电压	14.5±0.5V 35安培			
一箱只数	50			
铝壳尺寸				
重要说明				
产品编号	R2004.21	 <p>9线</p> <p>R2004.21</p>	 <p>1. Battery (+) / Bateria (+) 2. Battery (+) / Bateria (+) 3. Power Coil / Bobina de Carga 4. GND / Masa 5. GND / Masa 6. Ignition Switch / Sensor 7. Power Coil / Bobina de Carga 8. Power Coil / Bobina de Carga 9. Power Coil / Bobina de Carga</p> <p>R2004.21</p>	Kawasaki VN Vulcan Drifter 1500 2001 2005 21066-1126 Kawasaki VN Vulcan Mean Streak 1600 2004 2008 21066-1126 Reem lazo Shin ngen SH579A-12
产品单重	310克			
检测程序	M325			
电线插头	黄1.5 X 50CM 其他 1 平方			
内盒尺寸	12*9.5*6CM			
外箱尺寸	49.5*25.5*30.5CM			
输出电压	14.5±0.5V 30安培			
一箱只数	50			
铝壳尺寸				
重要说明	3黄线2红2黑1棕检测			
产品编号	R2004.22	 <p>R2004.22</p>	 <p>R2004.22</p>	Honda 75hp - 90hp 1997 - 2006 Outboard 31750-ZW1-003
产品单重				
检测程序	M325			
电线插头	15 25 30 65CM			
内盒尺寸	12*9.5*6CM			
外箱尺寸	49.5*25.5*30.5CM			
输出电压	14.5±0.5V			
一箱只数	50			
铝壳尺寸				
重要说明	3黄1白正1黑负1黑?			
产品编号	R2004.23	 <p>R2004.23</p>	 <p>1. Battery (+) / Bateria (+) 2. GND / Masa 3. Battery (+) / Bateria (+) 4. GND / Masa 5. Power Coil / Bobina de Carga 6. Power Coil / Bobina de Carga</p> <p>R2004.23</p>	Ducati 54040031A Ducati 434406040 Ducati 748 S 748 de 1997 a 1999 54040101A Ducati 748 Biposto / Monoposto 750 de 1997 a 1999 54040131A Ducati 916 SPS 996 Sport 916 de 1997 a 1998 54040131A Ducati 916 Senna III Monoposto 916 1998 54040131A Ducati Monster 750 de 1996 a 1997
产品单重	320克			
检测程序	M325-1 2642			
电线插头	黄1.5 X 25CM			
内盒尺寸	12*9.5*6CM			
外箱尺寸	49.5*25.5*30.5CM			
输出电压	14.5±0.5V 35安培			
一箱只数	50			
铝壳尺寸				
重要说明				

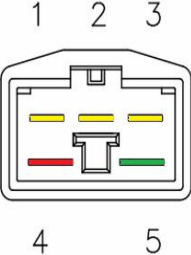
产品资料1		实物主图	接口图	适用范围
产品编号	R2004.24	 <p>R2004.24</p>	 <p>1. Battery (+) 2. Power Coil 3. Power Coil 4. GND</p> <p>R2004.24</p>	Honda 20hp V-twin Sh621a-12 Ref Hf2620
产品单重	320克			
检测程序	M325-1 2642			
电线插头	黄1.5 X 25CM			
内盒尺寸	12*9.5*6CM			
外箱尺寸	49.5*25.5*30.5CM			
输出电压	14.5±0.5V 35安培			
一箱只数	50			
铝壳尺寸				
重要说明				
产品编号	R2005.0	 <p>6针</p> <p>R2005.0</p>	 <p>1. Battery (+) / Bateria (+) 2. GND / Masa 3. Power Coil / Bobina de Carga 4. Power Coil / Bobina de Carga 5. Power Coil / Bobina de Carga</p> <p>R2005.0</p>	5BN-81960-00-00 5GT-81960-00-00 ; YAMAHA XVS1600 ATLER/ATLERC Road Star Silverado Limited YAMAHA XVS1600 ALER/ALERC Road Star Limited Edition YAMAHA XVS1100 V-Star 1100 Classic YAMAHA XVS1600 ASM/ASMC Road Star MM Limited YAMAHA XVS1600 ATN/ATNC/ATL/ATLC/ATM/ATMC Road Star Silverado
产品单重	240克			
检测程序	315			
电线插头	6插只用5针			
内盒尺寸	12*9.5*6CM			
外箱尺寸	49.5*25.5*30.5CM			
输出电压	14.5±0.5V			
一箱只数	50			
铝壳尺寸				
重要说明				
产品编号	R2005.1	 <p>5针</p> <p>R2005.1</p>	 <p>1. Battery (+) 2. GND 3. Power Coil 4. Power Coil 5. Power Coil</p> <p>R2005.1</p>	MBK Skyliner 150 2002 2010 4HM-81960-00 MBK Skyliner 125 2002 2010 4HM-81960-00 MBK Skyliner 180 2002 2010 4HM-81960-00 Suzuki DR SE 650 1996 2017 32800-32E00 Suzuki XF Freewind 650 s 1997 32800-32E00 Yamaha Flame X 125 4HM-81960-00
产品单重	240克			
检测程序	315			
电线插头	5针插头			
内盒尺寸	12*9.5*6CM			
外箱尺寸	49.5*25.5*30.5CM			
输出电压	14.5±0.5V			
一箱只数	50			
铝壳尺寸				
重要说明				
产品编号	R2005.1.2	 <p>6针</p> <p>R2005.1.2</p>	 <p>1. Battery (+) / Bateria (+) 2. Ignition Switch / Sensor 3. GND / Masa 4. Power Coil / Bobina de Carga 5. Power Coil / Bobina de Carga 6. Power Coil / Bobina de Carga</p> <p>R2005.1.2</p>	2443 Kawasaki KEF Lakota 300 1995 2000 21066-1089 Kawasaki KEF Lakota S ort 300 2001 2003 21066-1089 Kawasaki KFX 300 2001 2004 21066-1089 Kawasaki KLF Bayou 300 1988 1991 21066-1101 Kawasaki KLF Bayou 4x4 300 1989 2002 21066-1089
产品单重	240克			
检测程序	315 2443			
电线插头	6针插头			
内盒尺寸	12*9.5*6CM			
外箱尺寸	49.5*25.5*30.5CM			
输出电压	14.5±0.5V 25安培			
一箱只数	50			
铝壳尺寸				
重要说明				

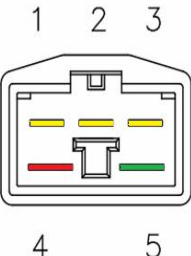





产品资料1		实物主图	接口图	适用范围
产品编号	R2005.1.3		 <ol style="list-style-type: none"> 1. Battery (+) / Bateria (+) 2. Ignition Switch / Sensor 3. GND / Masa 4. Power Coil / Bobina de Carga 5. Charge Lamp / Lámpara Piloto 6. Power Coil / Bobina de Carga 	John Deere M70121, M97348 Kawasaki 21066-2056, 21066-2070 Shindengen SH578-12, SH626-12
产品单重	260克			
检测程序	QF2101 新			
电线插头	25CM			
内盒尺寸	12*9.5*6CM			
外箱尺寸	49.5*25.5*30.5CM			
输出电压	14.5±0.5V			
一箱只数	50			
铝壳尺寸				
重要说明		R2005.1.3	R2005.1.3	
产品编号	R2005.2		 <ol style="list-style-type: none"> 1. Battery (+) / Bateria (+) 2. GND / Masa 3. Power Coil / Bobina de Carga 4. Power Coil / Bobina de Carga 5. Power Coil / Bobina de Carga 	YHC015/SKU254609/ Yamaha XVZ1300 A/AT Royal Star/ Tour Classic 1996-2000 Yamaha FZS600 Fazer 1998-2003 Yamaha XV1200 TD Venture '85-86' 3 Yamaha XV250 Virago Suzuki GSXR250 Suzuki GSXR400 GK71A Suzuki GSXR400 GK73A
产品单重	260克			
检测程序	315			
电线插头	25CM			
内盒尺寸	12*9.5*6CM			
外箱尺寸	49.5*25.5*30.5CM			
输出电压	14.5±0.5V			
一箱只数	50			
铝壳尺寸				
重要说明		R2005.2	R2005.2	
产品编号	R2005.2.1		 <ol style="list-style-type: none"> 1. Battery (+) / Bateria (+) 2. Ignition Switch / Sensor 3. GND / Masa 4. Power Coil / Bobina de Carga 5. Power Coil / Bobina de Carga 6. Power Coil / Bobina de Carga 	YHC083/SKU336559 SH650-12 21066-1099 SUZUKI GSXR400 GK76A YAMAHA FZ1 FZ 1000 FAZER 2001-2005 Yamaha XVS650 V-Star XV125 XV250 YHC-083 Kawasaki VN400 Kawasaki VN Vulcan 800 1995 2005 21066-1099 Kawasaki VN Classic 800 1996 2005 21066-1099 Kawasaki VN Drifter 800 2000 2006 21066-1099 Kawasaki ZX 6R Ninja 600 1998 1999
产品单重	260克			
检测程序	315			
电线插头	25CM			
内盒尺寸	12*9.5*6CM			
外箱尺寸	49.5*25.5*30.5CM			
输出电压	14.5±0.5V			
一箱只数	50			
铝壳尺寸				
重要说明		R2005.2.1	R2005.2.1	
产品编号	R2005.2.2		 <ol style="list-style-type: none"> 1. Battery (+) / Bateria (+) 2. GND / Masa 3. Power Coil / Bobina de Carga 4. Power Coil / Bobina de Carga 5. Power Coil / Bobina de Carga 	YAMAHA REGLER SRX XV 250 FZR FZS 600 YZF 600R 1000R R1 R6 XV XVS 650 FZ1 XTZ 750 Yamaha FZ1 XVX650 FZS1000Suzuki GSF400 1997-2000 GSXR400
产品单重	260克			
检测程序	315			
电线插头	25CM			
内盒尺寸	12*9.5*6CM			
外箱尺寸	49.5*25.5*30.5CM			
输出电压	14.5±0.5V			
一箱只数	50			
铝壳尺寸				
重要说明		R2005.2.2	R2005.2.2	



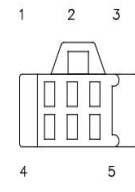

产品资料1		实物主图	接口图	适用范围
产品编号	R2005.3		 <p>1. Battery (+) / Bateria (+) 2. GND / Masa 3. Power Coil / Bobina de Carga 4. Power Coil / Bobina de Carga 5. Power Coil / Bobina de Carga</p>	SUZUKI GSXR400 GK76A YAMAHA FZ1 FZ 1000 FAZER 2001-2005 Yamaha XVS650 V-Star 雅马哈 天王太子 XV125 XV250
产品单重	260克			
检测程序	315			
电线插头	25CM			
内盒尺寸	12*9.5*6CM			
外箱尺寸	49.5*25.5*30.5CM			
输出电压	14.5±0.5V			
一箱只数	50			
铝壳尺寸				
重要说明				
产品编号	R2005.4		 <p>1. Power Coil / Bobina de Carga 2. Power Coil / Bobina de Carga 3. Power Coil / Bobina de Carga 4. Battery (+) / Bateria (+) 5. GND / Masa</p>	32800-18H00 32800-41F10 32800-41F11, SH650FB KAWASAKI NINJA ZX6R ZX 6R 636
产品单重	260克			
检测程序	315			
电线插头	25CM			
内盒尺寸	12*9.5*6CM			
外箱尺寸	49.5*25.5*30.5CM			
输出电压	14.5±0.5V			
一箱只数	50			
铝壳尺寸				
重要说明				
产品编号	R2005.5		 <p>1. Power Coil 2. Power Coil 3. Power Coil 4. Battery (+) 5. GND</p>	YHC033/SKU254764/SKU488858/ Yamaha YFM350 YFM 350 GRIZZLY ATV 2007-2008 WH110T (佳御110) 配插头 YHC-033稳压整流器 Yamaha YZF R1YZF600 X 500 TDM850 FZ6N FZ6S YZF R6
产品单重	200克			
检测程序	315			
电线插头	5针插头			
内盒尺寸	12*9.5*6CM			
外箱尺寸	49.5*25.5*30.5CM			
输出电压	14.5±0.5V			
一箱只数	50			
铝壳尺寸				
重要说明	白色铝壳			
产品编号	R2005.5+DX		 <p>1. Power Coil 2. Power Coil 3. Power Coil 4. Battery (+) 5. GND</p>	YHC033/SKU254764/SKU488858/ Yamaha YFM350 YFM 350 GRIZZLY ATV 2007-2008 WH110T (佳御110) 配插头 YHC-033稳压整流器 Yamaha YZF R1YZF600 X 500 TDM850 FZ6N FZ6S YZF R6 Kawasaki KAF MULE 4010 620 s 2014 21066-0717 Kawasaki KAF MULE 4000 620 2009 2012 21066-0037 Kawasaki KAF MULE 4000 620 s 2014 21066-0717
产品单重	200克			
检测程序	315			
电线插头	对插的线长20CM			
内盒尺寸	12*9.5*6CM			
外箱尺寸	49.5*25.5*30.5CM			
输出电压	14.5±0.5V			
一箱只数	50			
铝壳尺寸				
重要说明	白色铝壳			





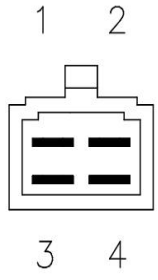
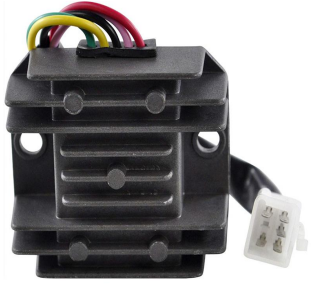
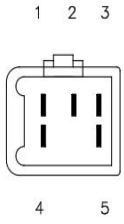

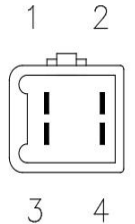
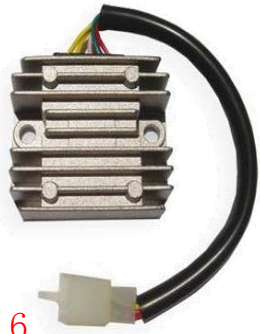
产品资料1		实物主图	接口图	适用范围
产品编号	R2005.8		 <p>1. Battery (+) / Bateria (+) 2. Ignition Switch/ Sensor 3. GND / Masa 4.</p> <p>5. AC Output / Salida AC 6. Power Coil / Bobina de Carga 7. Power Coil / Bobina de Carga 8. Power Coil / Bobina de Carga</p>	Kawasaki KLF Bayou 300 2002 2005 21066-1112 Kawasaki KSV KFX700 700 2004 2009 21066-1112 Kawasaki KVF rairie 650 2002 2003 21066-1112 Kawasaki KVF rairie 300 1999 2002 21066-1112 Kawasaki KVF rairie 700 2004 2006 21066-1112 Kawasaki KVF Brute ce 650 2011 2013
产品单重	净重255克			
检测程序	325 2358			
电线插头	35CM			
内盒尺寸	12*9.5*6CM			
外箱尺寸	49.5*25.5*30.5CM			
输出电压	14.5±0.5V 35安培			
一箱只数	50			
铝壳尺寸				
重要说明				
产品编号	R2005.8A		 <p>1. Battery (+) / Bateria (+) 2. Ignition Switch/ Sensor 3. GND / Masa 4. Battery (+) / Bateria (+)</p> <p>5. GND / Masa 6. Power Coil / Bobina de Carga 7. Power Coil / Bobina de Carga 8. Power Coil / Bobina de Carga</p>	Kawasaki KLF Bayou 300 2002 2005 21066-1112 Kawasaki KSV KFX700 700 2004 2009 21066-1112 Kawasaki KVF rairie 650 2002 2003 21066-1112 Kawasaki KVF rairie 300 1999 2002 21066-1112 Kawasaki KVF rairie 700 2004 2006 21066-1112 Kawasaki KVF Brute ce 650 2011 2013
产品单重	净重255克			
检测程序	325 2398			
电线插头	35和 65CM			
内盒尺寸	12*9.5*6CM			
外箱尺寸	49.5*25.5*30.5CM			
输出电压	14.5±0.5V 35安培			
一箱只数	50			
铝壳尺寸				
重要说明	3黑交流2黑红正2黑白负1棕检测			
产品编号	R2005.10		 <p>1. Battery (+) / Bateria (+) 2. Battery (+) / Bateria (+) 3. GND / Masa 4. GND / Masa</p> <p>5. Power Coil / Bobina de Carga 6. Power Coil / Bobina de Carga 7. Power Coil / Bobina de Carga</p>	2007-2008 Suzuki Bandit 1250 2007-2009 Suzuki Bandit 1250 ABS 2009 Suzuki Bandit 1250 S 2008-2009 Suzuki B-King GSX1300 2008 Suzuki B-King GSX1300 ABS 2005-2008 Suzuki Boulevard C90 2011 Suzuki GSX 1250 2008-2009 Suzuki GSX650F 2006-2011 Suzuki GSXR 600 2006-2011 Suzuki GSXR750 2007-2009 Suzuki GSXR 1000
产品单重	260克			
检测程序	M325			
电线插头	25CM			
内盒尺寸	12*9.5*6CM			
外箱尺寸	49.5*25.5*30.5CM			
输出电压	14.5±0.5V			
一箱只数	50			
铝壳尺寸				
重要说明				
产品编号	R2005.10A		 <p>1. Battery (+) / Bateria (+) 2. Battery (+) / Bateria (+) 3. GND / Masa 4. GND / Masa</p> <p>5. Power Coil / Bobina de Carga 6. Power Coil / Bobina de Carga 7. Power Coil / Bobina de Carga</p>	Suzuki Hayabusa GSX1300R 2008-2013 32800-15840-RX0 RX41 15H1 15H0 32800-15H10-000
产品单重	260克 净重 230克			
检测程序	M325			
电线插头	25CM			
内盒尺寸	12*9.5*6CM			
外箱尺寸	49.5*25.5*30.5CM			
输出电压	14.5±0.5V			
一箱只数	50			
铝壳尺寸				
重要说明				



产品资料1		实物主图	接口图	适用范围
产品编号	R2005.11		 <p>1. Battery (+) / Bateria (+) 2. GND / Masa 3. Power Coil / Bobina de Carga 4. Power Coil / Bobina de Carga</p> <p>5. Power Coil / Bobina de Carga 6. Field Coil / Bobina de Campo 7. Ignition Switch / Sensor</p>	2412 Yamaha XS 1100 1978 1981 1T4-81960-A0-00 Yamaha XS 850 1980 1981 1T4-81960-A0-00 Yamaha XS 750 1978 1T4-81960-92-00 Yamaha XS 850 1980 1T4-81960-92-00 Yamaha XS 750 1977 1979 1T4-81960-A0-00 Yamaha XS 1100 1979 1980 1T4-81960-92-00
产品单重	260克			
检测程序	CB750+励磁 2412			
电线插头	25CM			
内盒尺寸	12*9.5*6CM			
外箱尺寸	49.5*25.5*30.5CM			
输出电压	14.5±0.5V 25安培			
一箱只数	50			
铝壳尺寸				
重要说明	3白线交流1红正2 绿负1 棕检测			
产品编号	R2005.12		 <p>1. GND / Masa 2. Ignition Switch / Sensor 3. Battery (+) / Bateria (+) 4. Power Coil / Bobina de Carga</p> <p>5. Power Coil / Bobina de Carga 6. Power Coil / Bobina de Carga 7. Power Coil / Bobina de Carga</p>	Kawasaki Ninja ZX6RR ZX600N 2005 2006 sh650fb-12 21066-0016
产品单重	310克			
检测程序	325			
电线插头	30CM			
内盒尺寸	12*9.5*6CM			
外箱尺寸	49.5*25.5*30.5CM			
输出电压	14.5±0.5V			
一箱只数	50			
铝壳尺寸				
重要说明	4黑交流 1绿负1红线正1棕检测			
产品编号	R2005.13		 <p>1. Battery (+) / Bateria (+) 2. Ignition Switch / Sensor 3. GND / Masa 4. Power Coil / Bobina de Carga 5. Power Coil / Bobina de Carga 6. Power Coil / Bobina de Carga</p>	Kawasaki ZXR250 1989-1995 Kawasaki ZZR400 1990-1999 Kawasaki ZZR600 1990-2005 白线正极黑线负极棕线检测黄线交流
产品单重	222克			
检测程序	325			
电线插头	25CM			
内盒尺寸	12*9.5*6CM			
外箱尺寸	49.5*25.5*30.5CM			
输出电压	14.5±0.5V			
一箱只数	50			
铝壳尺寸				
重要说明	3黄交流1白正1黑负 1棕检测线			
产品编号	R2005.14		 <p>1. Battery (+) / Bateria (+) 2. Ignition Switch / Sensor 3. GND / Masa 4. Power Coil / Bobina de Carga 5. Power Coil / Bobina de Carga 6. Power Coil / Bobina de Carga</p>	2433 JiansheATV250 MotomeIQuest250 ZanellaG-ce250
产品单重				
检测程序	325 2433			
电线插头	20CM			
内盒尺寸	12*9.5*6CM			
外箱尺寸	49.5*25.5*30.5CM			
输出电压	14.5±0.5V 12安培			
一箱只数	50			
铝壳尺寸				
重要说明	6线			



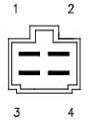

产品资料1		实物主图	接口图	适用范围
产品编号	R2005.15	5线 		Yamaha TIMBERWOLF 250 4X4 1998-2000
产品单重				
检测程序	325			
电线插头	25CM			
内盒尺寸	12*9.5*6CM			
外箱尺寸	49.5*25.5*30.5CM			
输出电压	14.5±0.5V			
一箱只数	50			
铝壳尺寸				
重要说明	3白交流 1白 正1黑负			
产品编号	R2005.16	5线 	 <p>1. Battery (+) / Bateria (+) 2. GND / Masa 3. Power Coil / Bobina de Carga 4. Power Coil / Bobina de Carga 5. Power Coil / Bobina de Carga</p>	Kawasaki KZ LTD 750 1980 1983 21066-1027 Kawasaki KZ olice 1000 1979 1981 21066-1008 Kawasaki KZ CSR 1000 1981 1982 21066-1008 Kawasaki KZ750 1980 1982 21066-1008 Kawasaki KZ CSR 650 1981 1983 21066-1027 Kawasaki KZ Classic 1000 1980 21066-1008
产品单重				
检测程序	325 2069			
电线插头	25CM			
内盒尺寸	12*9.5*6CM			
外箱尺寸	49.5*25.5*30.5CM			
输出电压	14.5±0.5V 25安培			
一箱只数	50			
铝壳尺寸				
重要说明				
产品编号	R2005.17	6线 	 <p>1. Battery (+) / Bateria (+) 2. GND / Masa 3. Power Coil / Bobina de Carga 4. Power Coil / Bobina de Carga 5. Power Coil / Bobina de Carga 6. Ignition Switch / Sensor</p>	Kawasaki KZ LTD 750 1980 1983 21066-1027 Kawasaki KZ olice 1000 1979 1981 21066-1008 Kawasaki KZ CSR 1000 1981 1982 21066-1008 Kawasaki KZ750 1980 1982 21066-1008 Kawasaki KZ CSR 650 1981 1983 21066-1027 Kawasaki KZ Classic 1000 1980 21066-1008
产品单重				
检测程序	325 2069			
电线插头	25CM			
内盒尺寸	12*9.5*6CM			
外箱尺寸	49.5*25.5*30.5CM			
输出电压	14.5±0.5V 25安培			
一箱只数	50			
铝壳尺寸				
重要说明	3黄交流1红正1绿负 1黑检测线			
产品编号	R2005.17	6线 	 <p>1. Ignition Switch / Sensor 2. Battery (+) / Bateria (+) 3. GND / Masa 4. Power Coil / Bobina de Carga 5. Power Coil / Bobina de Carga 6. Power Coil / Bobina de Carga</p>	2068 25A Kawasaki - 21066-1028 Kawasaki BJ Estrella 250 1994 21066-1030 Kawasaki EL Eliminator 250 1988 2003 21066-1030 Kawasaki EL HS 250 1991 1994 21066-1030 Kawasaki EN LTD 454 1985 1990 21066-1030 Kawasaki EN Vulcan 400 1989 1994
产品单重				
检测程序	325			
电线插头	25CM			
内盒尺寸	12*9.5*6CM			
外箱尺寸	49.5*25.5*30.5CM			
输出电压	14.5±0.5V 25安培			
一箱只数	50			
铝壳尺寸				
重要说明	3黄交流1红正1绿负 1黑检测线			

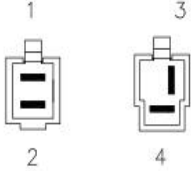
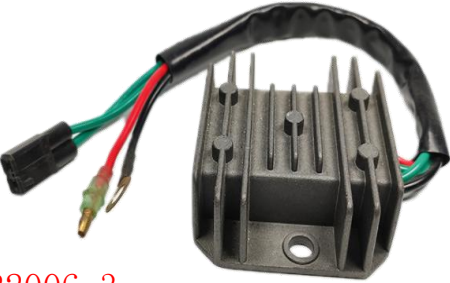
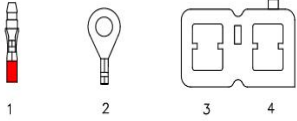
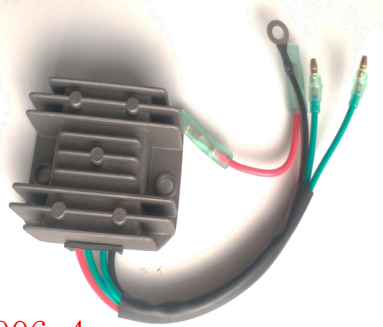
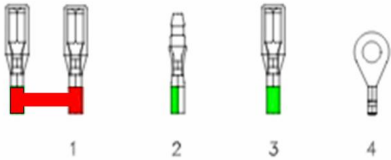

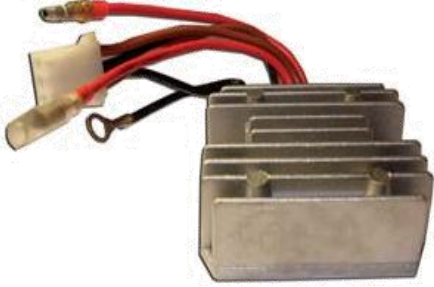
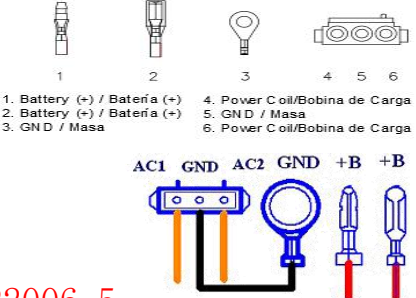

产品资料1		实物主图	接口图	适用范围
产品编号	R2006.0		 <p>1. Power Coil / Bobina de Carga 2. Ignition Switch / Sensor 3. GND / Masa 4. Battery (+) / Bateria (+) 5. Power Coil / Bobina de Carga</p>	First Rate Legnano Monsa 150 First Rate Legnano Modena 200 First Rate Legnano Capri G2 110 First Rate Legnano Imola G2 110 First Rate Legnano Verona SS 125 First Rate Legnano Milano 150 First Rate Legnano Milano Sprint 150 Gilera JL 150 Gilera LX 3A 100 Gilera QM 7B 125 Gilera YL 125
产品单重	135克			
检测程序	215 10075 2048			
电线插头	15CM			
内盒尺寸	100*85*30MM			
外箱尺寸	49.5*25.5*30.5CM			
输出电压	14.5±0.5V 12安培			
一箱只数	50			
铝壳尺寸				
重要说明				
产品编号	R2006.0A		 <p>1. Power Coil / Bobina de Carga 2. Lights (+) / Luces (+) 3. GND / Masa 4. Battery (+) / Bateria (+) 5. Power Coil / Bobina de Carga</p>	2437 Brava Altino R 150 2014 Corven Hunter 150 2015 Ghiggeri Vita 110 Guerrero GFT Ma uche 250 Keller Big KN110-7 110 Keller Crono Classic KN110-8 110 Keller Crono Classic KN125-11 125 Keller Crono Trial KN125-12 125 Keller Crono Tunning KN125-11 125 Keller Excellence KN250-3 250
产品单重	135克 净重100克			
检测程序	215 2437 CC+LUCES			
电线插头	15CM			
内盒尺寸	100*85*30MM			
外箱尺寸	49.5*25.5*30.5CM			
输出电压	14.5±0.5V 12安培			
一箱只数	50			
铝壳尺寸				
重要说明	2 号线是 大灯线			
产品编号	R2006.0.1		 <p>1. Power Coil / Bobina de Carga 2. GND / Masa 3. Battery (+) / Bateria (+) 4. Power Coil / Bobina de Carga</p>	10178 Cerro Extreme 250 s 2007 Cerro Fire R 110 s 2007 Cerro Seed 200 s 2007 Ghiggeri Trattore 200 Gilera T 150 Motomel Gorilla 150 Panther R 110 Zanella FX 200
产品单重	135克			
检测程序	215 10178			
电线插头	15CM小线			
内盒尺寸	100*85*30MM			
外箱尺寸	49.5*25.5*30.5CM			
输出电压	14.5±0.5V 12安培			
一箱只数	50			
铝壳尺寸				
重要说明				
产品编号	R2006.0.2		 <p>1. Battery (+) 2. Power Coil 3. Power Coil 4. GND</p>	10045 Motomel VX 150
产品单重	135克			
检测程序	215 10045			
电线插头	15CM小线			
内盒尺寸	100*85*30MM			
外箱尺寸	49.5*25.5*30.5CM			
输出电压	14.5±0.5V 12安培			
一箱只数	50			
铝壳尺寸	黑色氧化铝壳			
重要说明				

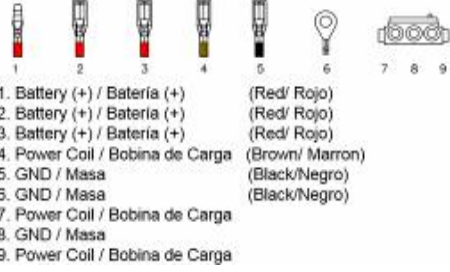
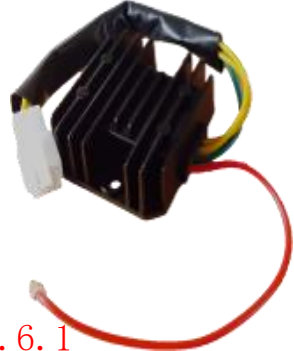
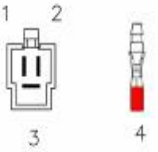
产品资料1		实物主图	接口图	适用范围
产品编号	R2006.0.2B		 <p>1 2 3 4</p> <ol style="list-style-type: none"> 1. Battery (+) 2. Power Coil 3. Power Coil 4. GND 	Honda ATC 200 TRX 200 1982-1984 OEM 08615-9580004 31600-958-680 31600-958-681 31600-958-682 31600-VM5-000 改装 后适用于 HondaBig Red 200ATC200E 31600-958-680
产品单重	135克			
检测程序	215			
电线插头	15CM小线			
内盒尺寸	100*85*30MM			
外箱尺寸	49.5*25.5*30.5CM			
输出电压	14.5±0.5V			
一箱只数	50			
铝壳尺寸	白色喷砂铝壳			
重要说明	配对插			
产品编号	R2006.0.4		 <p>1 2 3 4 5</p> <ol style="list-style-type: none"> 1. GND / Masa 2. Lights (+) / Luces (+) 3. Power Coil / Bobina de Carga 4. Power Coil / Bobina de Carga 5. Battery (+) / Bateria (+) 	2441 Corven Triax 150 s 2017 Corven Triax R3 250 s 2017 Corven Triax 200 2016 Reem lazo ietcard 1418 Universal Luces Encendidas Zanella Due Classic 110 s 2013 Zanella Due Sport 125 2013 Zanella RX 150 2013 Zanella ZB 125 2013 Zanella ZB G4 110 s 2012 200-32100
产品单重	135克			
检测程序	215 2441 CC+LUCES			
电线插头	15CM小线			
内盒尺寸	100*85*30MM			
外箱尺寸	49.5*25.5*30.5CM			
输出电压	14.5±0.5V 12安培			
一箱只数	50			
铝壳尺寸				
重要说明	成品要 配对插			
产品编号	R2006.0.5		 <p>1 2 3 4</p> <ol style="list-style-type: none"> 1. Power Coil / Bobina de Carga 2. GND / Masa 3. Battery (+) / Bateria (+) 4. Power Coil / Bobina de Carga 	2373 Cerro CE rince 150-16 150 Cerro CE 13 150 Cerro CE 12 125 Guerrero Flash G 110 Konisa Win K LF J 125 Motomel SR 200 Motomel TC 200 Motomel XMM 250 Reem lazo ietcard 1299 Reem lazo ietcard 1217
产品单重	135克			
检测程序	215 2373			
电线插头	15CM小线			
内盒尺寸	100*85*30MM			
外箱尺寸	49.5*25.5*30.5CM			
输出电压	14.5±0.5V 12安培			
一箱只数	50			
铝壳尺寸				
重要说明				
产品编号	R2006.0.6		 <p>1 2 3 4 5</p> <ol style="list-style-type: none"> 1. Ignition Switch / Sensor 2. Power Coil / Bobina de Carga 3. GND / Masa 4. Battery (+) / Bateria (+) 5. Power Coil / Bobina de Carga 	2047 12A Motomel Hero uch 65
产品单重	135克			
检测程序	215 2047			
电线插头	15CM			
内盒尺寸	100*85*30MM			
外箱尺寸	49.5*25.5*30.5CM			
输出电压	14.5±0.5V 12安培			
一箱只数	50			
铝壳尺寸				
重要说明				

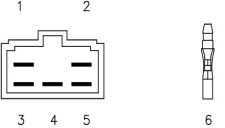

产品资料1		实物主图	接口图	适用范围
产品编号	R2006.1		 <ol style="list-style-type: none"> 1. Power Coil / Bobina de Carga 2. Ignition Switch / Sensor 3. GND / Masa 4. Battery (+) / Bateria (+) 5. Power Coil / Bobina de Carga 	10033 12A Beta BK 150 Gilera CD 100 Gilera LX 3B 100 Juki Mondial FD 150 Mondial HD 150 Zanella RX 150 2049 12A A ia Bless 150 A ia DCN 110 hasta 2005 Beta BK 150
产品单重	135克			
检测程序	215 10033 2049			
电线插头	15CM小线			
内盒尺寸	100*85*30MM			
外箱尺寸	49.5*25.5*30.5CM			
输出电压	14.5±0.5V 12安培			
一箱只数	50			
铝壳尺寸				
重要说明				
产品编号	R2006.1.2		 <ol style="list-style-type: none"> 1. Power Coil / Bobina de Carga 2. GND / Masa 3. Battery (+) / Bateria (+) 4. Power Coil / Bobina de Carga 5. Lights (+) / Luces (+) 	2457 Gilera Sahel 150 Gilera VC Strada 150 2013 Guerrero GC Queen 200 s 2013 Guerrero Kryon 150 s 2013 Keller Big KN 110 Keller Crono Classic KN 110 Keller Crono Trial KN 125 Keller Crono Tunning KN 125 Keller Excellence KN 250 Keller Excellence KN 150
产品单重	135克			
检测程序	215 CC+LUCES 2457			
电线插头	20CM小线			
内盒尺寸	100*85*30MM			
外箱尺寸	49.5*25.5*30.5CM			
输出电压	14.5±0.5V 12安培			
一箱只数	50			
铝壳尺寸				
重要说明				
产品编号	R2006.2		 <ol style="list-style-type: none"> 1. Power Coil / Bobina de Carga 2. GND / Masa 3. Battery (+) / Bateria (+) 4. Power Coil / Bobina de Carga 	2462 A ia City lus 110 hasta 2012 A ia DCN 110 2006 2008 A ia Montero II 150 Beta Master 150 Cerro BIX CE-21 110 2011 Corven Triax Motard 200 s 2012 Corven Triax 150 s 2012 Corven Triax 250 s 2012 Gilera Free Runner 150 Gilera VC Strada 150
产品单重	135克			
检测程序	215 2462			
电线插头	20CM小线			
内盒尺寸	100*85*30MM			
外箱尺寸	49.5*25.5*30.5CM			
输出电压	14.5±0.5V 12安培			
一箱只数	50			
铝壳尺寸				
重要说明	用白色铝壳			
产品编号	R2006.2A		 <ol style="list-style-type: none"> 1. Power Coil / Bobina de Carga 2. GND / Masa 3. Battery (+) / Bateria (+) 4. Power Coil / Bobina de Carga 5. Lights (+) / Luces (+) 	2458 Keller Big KN 110 Keller Crono Classic KN 110 Keller Crono Trial KN 125 Keller Crono Tunning KN 125 Keller Excellence KN 150 Keller Excellence KN 250 Keller KN 125 Keller Miracle KN 150 Keller Stratus KN 260 Keller Stratus KN 150
产品单重	135克			
检测程序	215 2458 CC+LUCES			
电线插头	20CM小线			
内盒尺寸	100*85*30MM			
外箱尺寸	49.5*25.5*30.5CM			
输出电压	14.5±0.5V 12安培			
一箱只数	50			
铝壳尺寸				
重要说明				

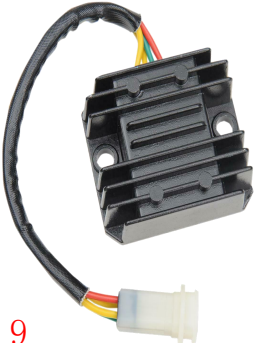

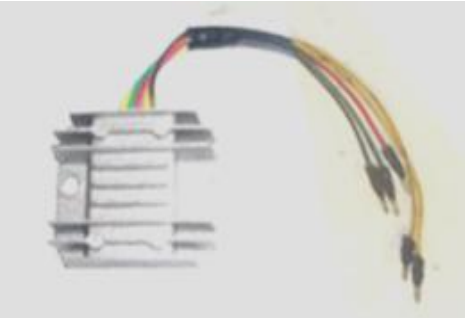
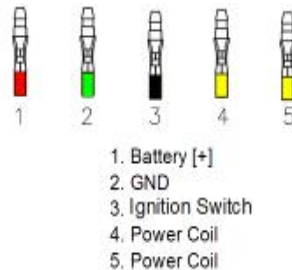
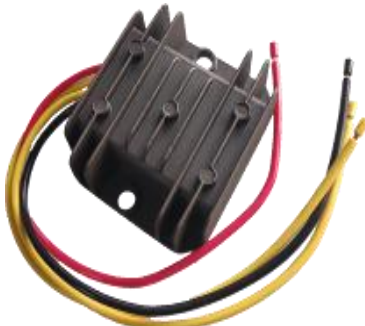
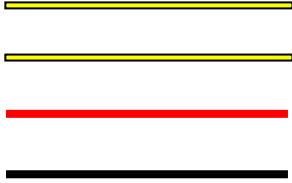

产品资料1		实物主图	接口图	适用范围
产品编号	R2006. 2. 1		 <p>1. Power Coil / Bobina de Carga 2. Power Coil / Bobina de Carga 3. Battery (+) / Bateria (+) 4. GND / Masa</p>	2485 25A Reem lazo Shin ngen SH522G-12 Yamaha XT 600 1984 1986 34L-81960-A0 Yamaha XT Z TENERE 600 1983 1985 34L-81960-A0
产品单重	135克			
检测程序	215 2485			
电线插头	20 25CM小线			
内盒尺寸	100*85*30MM			
外箱尺寸	49.5*25.5*30.5CM			
输出电压	14.5±0.5V 25安培			
一箱只数	50			
铝壳尺寸				
重要说明				
产品编号	R2006. 3		 <p>1. Battery (+) / Bateria (+) 2. GND / Masa 3. Power Coil / Bobina de Carga 4. Power Coil / Bobina de Carga</p>	Yamaha - Todas exce to SUV 1200 2000 2005 66V-81960-00 Yamaha FX 1100 2002 2004 66V-81960-00 Yamaha G R 1300 2003 2005 66V-81960-00 Yamaha XL LTD 1200 1999 66V-81960-00 SH522H-12
产品单重	135克			
检测程序	215 2362			
电线插头	20CM小线			
内盒尺寸	100*85*30MM			
外箱尺寸	49.5*25.5*30.5CM			
输出电压	14.5±0.5V 25安培			
一箱只数	50			
铝壳尺寸				
重要说明				
产品编号	R2006. 4		 <p>1. Battery (+) / Bateria (+) 2. Power Coil / Bobina de Carga 3. Power Coil / Bobina de Carga 4. GND / Masa</p> <p>(Red/ Rojo) (Green-White/ Verde-Blanco) (Green/Verde)</p>	Yamaha 2 Cyl 2.205 Bore 4 Stroke 15 1998-2005 Yamaha 2 Cyl 4 Stroke 9.9 1998-2006 6G8-81960-A1 Yamaha Outboard 1990-2006 4 Stroke 9.9 15H
产品单重	135克			
检测程序	215			
电线插头	6 20CM小线			
内盒尺寸	100*85*30MM			
外箱尺寸	49.5*25.5*30.5CM			
输出电压	14.5±0.5V			
一箱只数	50			
铝壳尺寸				
重要说明				
产品编号	R2006. 4A			YAMAHA 50H 60H 75H 80H 90H 115H 6H0-81960-00-00
产品单重	135克			
检测程序	215			
电线插头	6 20 45CM小线			
内盒尺寸	100*85*30MM			
外箱尺寸	49.5*25.5*30.5CM			
输出电压	14.5±0.5V			
一箱只数	50			
铝壳尺寸				
重要说明				

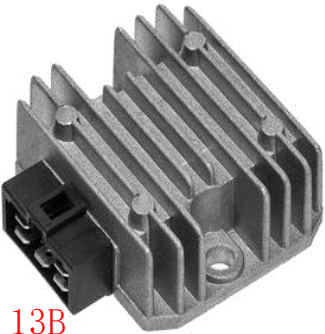
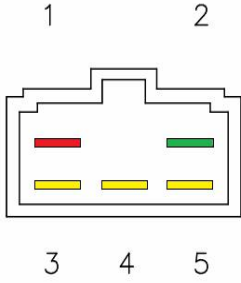

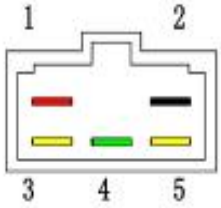
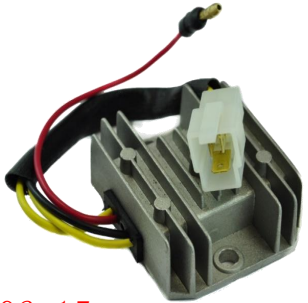
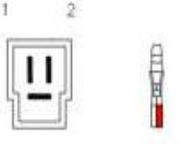
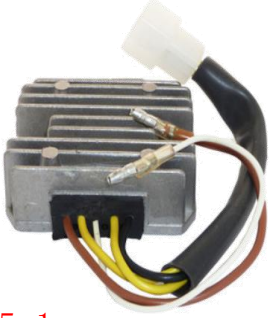
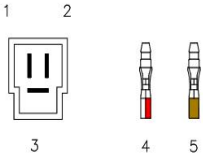

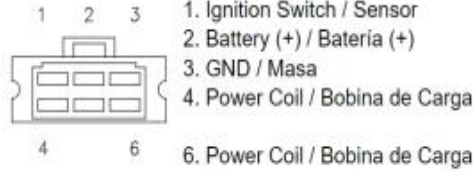
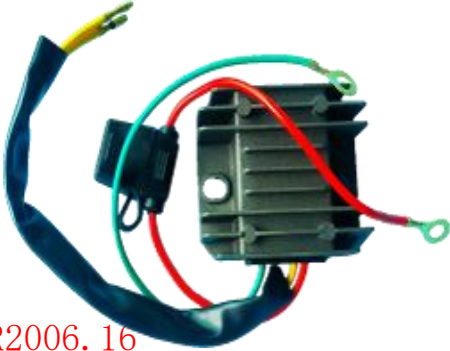
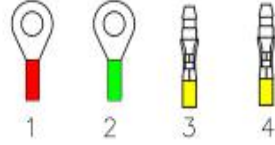

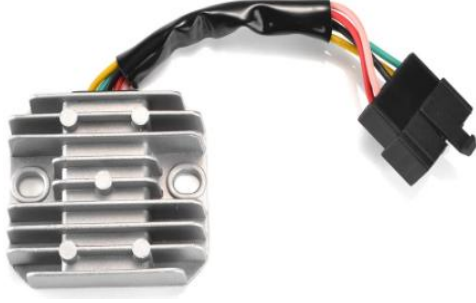
产品资料1		实物主图	接口图	适用范围
产品编号	R2006.5		 <p>1. Battery (+) / Bateria (+) 2. Battery (-) / Bateria (-) 3. GND / Masa 4. Power Coil / Bobina de Carga 5. GND / Masa 6. Power Coil / Bobina de Carga</p> <p>AC1 GND AC2 GND +B +B</p>	Kawasaki JS 750 1992 1995 21066-3709 Kawasaki JS SX-R 800 2003 2011 21066-3709 Kawasaki JS SXI 750 1995 1997 21066-3709 Kawasaki JS SXI ro 750 1998 2002 21066-3709 Reem lazo Shin ngen SH522F-12
产品单重	135克			
检测程序	215 10146			
电线插头	小线 8 20 CM			
内盒尺寸	100*85*30MM			
外箱尺寸	49.5*25.5*30.5CM			
输出电压	14.5±0.5V 20安培			
一箱只数	50			
铝壳尺寸				
重要说明				
产品编号	R2006.5.1		 <p>1. Battery (+) / Bateria (+) (Red/ Rojo) 2. Battery (+) / Bateria (+) (Red/ Rojo) 3. Battery (+) / Bateria (+) (Red/ Rojo) 4. Power Coil / Bobina de Carga (Brown/ Marron) 5. GND / Masa (Black/ Negro) 6. GND / Masa (Black/ Negro) 7. Power Coil / Bobina de Carga 8. GND / Masa 9. Power Coil / Bobina de Carga</p>	Kawasaki JH Jet Ski Sport XI 750 1998 1999 21066-3711 Kawasaki JH Jet Ski Super Sport XI 750 1993 1997 21066-3711 Kawasaki JH Jet Ski STS 750 1995 1997 21066-3711 Kawasaki JH Jet Ski XIR 750 1994 21066-3711 Kawasaki JH Jet Ski SS 750 1992 1997 21066-3711 Kawasaki IT 750 1994 1995 21066-
产品单重	135克			
检测程序	215 10145			
电线插头	小线 8 20 CM			
内盒尺寸	100*85*30MM			
外箱尺寸	49.5*25.5*30.5CM			
输出电压	14.5±0.5V 20安培			
一箱只数	50			
铝壳尺寸				
重要说明				
产品编号	R2006.6.1		 <p>1. Power Coil / Bobina de Carga 2. Power Coil / Bobina de Carga 3. GND / Masa 4. Battery (+) / Bateria (+)</p>	Kawasaki KZ200 KZ400 KZ440 KZ650 KZ750 - Rick's Motors Sport Kawasaki KZ200 KZ400 KZ440 KZ650 KZ750 Twin
产品单重	135克			
检测程序	208			
电线插头	20CM小线			
内盒尺寸	100*85*30MM			
外箱尺寸	49.5*25.5*30.5CM			
输出电压	14.5±0.5V			
一箱只数	50			
铝壳尺寸	3插是带钩的			
重要说明	2黄1红1绿			
产品编号	R2006.6.2		 <p>1. Ignition Switch / Sensor 2. GND / Masa 3. Power Coil / Bobina de Carga 4. Power Coil / Bobina de Carga 5. Power Coil / Bobina de Carga 6. Battery (+) / Bateria (+)</p>	2069 25A Kawasaki KZ LTD 750 1980 1983 21066-1027 Kawasaki KZ Police 1000 1979 1981 21066-1008 Kawasaki KZ CSR 1000 1981 1982 21066-1008 Kawasaki KZ 750 1980 1982 21066-1008 Kawasaki KZ CSR 650 1981 1983 21066-1027
产品单重	135克			
检测程序	315 2069			
电线插头	20 25CM小线			
内盒尺寸	100*85*30MM			
外箱尺寸	49.5*25.5*30.5CM			
输出电压	14.5±0.5V 25安培			
一箱只数	50			
铝壳尺寸				
重要说明	3黄1白1棕是检测线1黑线是负极			



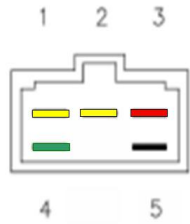

产品资料1		实物主图	接口图	适用范围
产品编号	R2006.8			LUCAS 12V Solid State Regulator Rectifier replaces rectifier and zener dio BSA
产品单重	克			
检测程序	215			
电线插头	20CM			
内盒尺寸				
外箱尺寸	49.5*25.5*30.5CM			
输出电压	14.5±0.5V			
一箱只数	50			
铝壳尺寸				
重要说明				
产品编号	R2006.9			Yamaha YFM200 Moto-4 1986-1988 Yamaha YTM200 Tri-Moto 1983-1985 Yamaha YTM225 Tri-Moto 1983-1986
产品单重	克			
检测程序	215			
电线插头	25CM			
内盒尺寸				
外箱尺寸	49.5*25.5*30.5CM			
输出电压	14.5±0.5V			
一箱只数	50			
铝壳尺寸				
重要说明				
产品编号	R2006.10		 <p>1. Battery [+] 2. GND 3. Ignition Switch 4. Power Coil 5. Power Coil</p>	HONDA TRX200 SX SH522B-12
产品单重	135克			
检测程序	215			
电线插头	20 25CM小线			
内盒尺寸	100*85*30MM			
外箱尺寸	49.5*25.5*30.5CM			
输出电压	14.5±0.5V			
一箱只数	50			
铝壳尺寸				
重要说明				
产品编号	R2006.11			凯旋 Trium h BSA, Norton, Trium h voltage regulator. Re laces Lucas rectifier & zener dio
产品单重	净重 102克			
检测程序	215			
电线插头	20CM小线			
内盒尺寸	100*85*30MM			
外箱尺寸	49.5*25.5*30.5CM			
输出电压	14.5±0.5V			
一箱只数	50			
铝壳尺寸				
重要说明				

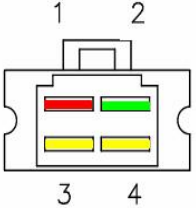



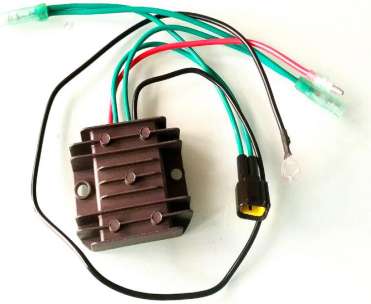
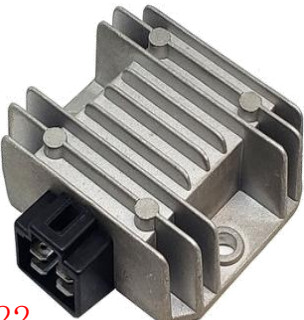
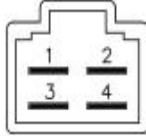

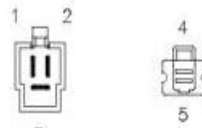
产品资料1		实物主图	接口图	适用范围
产品编号	R2006.12		 <ol style="list-style-type: none"> 1. Battery (+) / Bateria (+) 2. Ignition Switch / Sensor 3. GND / Masa 4. Power Coil / Bobina de Carga 5. Power Coil / Bobina de Carga 	2380 Honda SDH Storm 125 2006 2008 31600-KRF-B50 Reem lazo ietcard 1267 Yamaha XTZ 250 4B4-H1960-00
产品单重	135克			
检测程序	215 2480			
电线插头	5针插头			
内盒尺寸	100*85*30MM			
外箱尺寸	49.5*25.5*30.5CM			
输出电压	14.5±0.5V 25安培			
一箱只数	50			
铝壳尺寸				
重要说明				
产品编号	R2006.12安培		 <ol style="list-style-type: none"> 1. Battery (+) / Bateria (+) 2. Ignition Switch / Sensor 3. GND / Masa 4. Power Coil / Bobina de Carga 5. Power Coil / Bobina de Carga 	Yamaha Nmax 125 2015-2020
产品单重	135克			
检测程序	215 2081			
电线插头	5针插头			
内盒尺寸	100*85*30MM			
外箱尺寸	49.5*25.5*30.5CM			
输出电压	14.5±0.5V 35安培			
一箱只数	50			
铝壳尺寸				
重要说明	5针插头			
产品编号	R2006.13		 <ol style="list-style-type: none"> 1. Battery (+) / Bateria (+) 2. Ignition Switch / Sensor 3. GND / Masa 4. Power Coil / Bobina de Carga 5. Power Coil / Bobina de Carga 6. Power Coil / Bobina de Carga 	2442 25A Kawasaki KAF Mule 550 300 hasta 2007 21066-2004 Kawasaki KAF Mule 520 300 hasta 2007 21066-2004 Kawasaki KAF Mule 500 300 hasta 2007 21066-2004 Kawasaki KLF Bayou 220 1996 2011 21066-1038 Kawasaki KLF Bayou 185 1986 1988 21066-1052
产品单重	135克			
检测程序	315 2442 2065			
电线插头	6针插头			
内盒尺寸	100*85*30MM			
外箱尺寸	49.5*25.5*30.5CM			
输出电压	14.5±0.5V 25安培			
一箱只数	50			
铝壳尺寸	安装孔中心距离 55MM			
重要说明	6针插头			
产品编号	R2006.13A		 <ol style="list-style-type: none"> 1. Power Coil / Bobina de Carga 2. GND / Masa 3. Battery (+) / Bateria (+) 4. Power Coil / Bobina de Carga 5. GND / Masa 6. Lights (+) / luces (+) 	2422 Keller Big KN110-7 110 Keller Crono Classic KN110-8 110 Keller Crono Classic KN125-11 125 Keller Crono Trial KN125-12 125 Keller Crono Tuning KN125-11 125 Keller Excellence KN150-3 150 Keller Excellence KN250-3 250 Keller Miracle KN150GY 150 Keller Stratus KN150-13 150 Keller Stratus KN260 260
产品单重	135克			
检测程序	315 2422			
电线插头	6针插头			
内盒尺寸	100*85*30MM			
外箱尺寸	49.5*25.5*30.5CM			
输出电压	14.5±0.5V 12安培			
一箱只数	50			
铝壳尺寸				
重要说明	6针插头带大灯线			

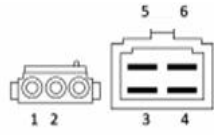

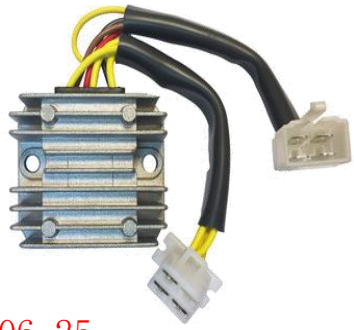
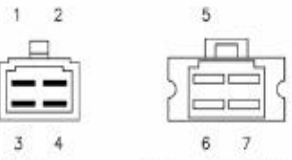

产品资料1		实物主图	接口图	适用范围
产品编号	R2006.13B		 <p>1. Battery (+) 2. GND 3. Power Coil 4. Power Coil 5. Power Coil</p>	2081 35A Reem lazo Shin ngen SH553 Yamaha XC Riva 125 1991 36F-81960-A0 Yamaha XC Riva 125 1992 2000 36F-81960-A1 Yamaha XC Riva 125 1985 1990 36F-81960-A1 Yamaha XC 125 2001 36F-81960-A2 Yamaha XC Cygnus 125 1993 36F-81960-A0
产品单重	135克			
检测程序	315 2081			
电线插头	5针插头			
内盒尺寸	100*85*30MM			
外箱尺寸	49.5*25.5*30.5CM			
输出电压	14.5±0.5V 35安培			
一箱只数	50			
铝壳尺寸				
重要说明	5针插头			
产品编号	R2006.14		 <p>1. Battery (+) 2. Ignition 3. Power Coil 4. GND (-) 5. Power Coil</p>	21066-1052 Kawasaki KLF 185 A4 1988 Regualtor Voltage 21066-1052 A16
产品单重	135克			
检测程序	215			
电线插头	20CM小线			
内盒尺寸	100*85*30MM			
外箱尺寸	49.5*25.5*30.5CM			
输出电压	14.5±0.5V			
一箱只数	50			
铝壳尺寸				
重要说明	粉红色线是交流			
产品编号	R2006.15		 <p>1. Power Coil / Bobina de Carga 2. Power Coil / Bobina de Carga 3. GND/ Masa 4. Battery (+) / Bateria (+)</p>	2315 25A SH521-12 Kawasaki KZ 200 1978 1979 21066-029 Kawasaki KZ 400 1978 1979 21066-029 Kawasaki KZ 650 1977 1979 21066-029 Kawasaki KZ 750 1976 1979 21066-029 Kawasaki KZ 300 1981 1982 21066-1013
产品单重	140克			
检测程序	215 2315			
电线插头	20CM小线			
内盒尺寸	100*85*30MM			
外箱尺寸	49.5*25.5*30.5CM			
输出电压	14.5±0.5V 25安培			
一箱只数	50			
铝壳尺寸				
重要说明	2黄1红正1黑负 3插是不带钩的			
产品编号	R2006.15.1		 <p>1. Power Coil / Bobina de Carga 2. Power Coil / Bobina de Carga 3. GND/ Masa 4. Battery (+) / Bateria (+) (White-Red/ Blanco-Rojo) 5. Ignition Switch / Sensor (Brown/Marron)</p>	2313 25A Kawasaki KZ 250 1980 21066-1014 Kawasaki KZ 440 1980 1982 21066-1014 Kawasaki KZ 650 1980 21066-1014 Kawasaki KZ LTD II 750 1980 21066-1014 Kawasaki KZ LTD 1000 1980 1982 21066-1014 Kawasaki KZ CSR 250 1981 21066-1014 Kawasaki KZ CSR Belt 250 1982 21066-
产品单重	135克			
检测程序	215 2430 2313			
电线插头	20CM小线			
内盒尺寸	100*85*30MM			
外箱尺寸	49.5*25.5*30.5CM			
输出电压	14.5±0.5V 25安培			
一箱只数	50			
铝壳尺寸	安装孔距55MM			
重要说明	3插是不带钩的			

产品资料1		实物主图	接口图	适用范围
产品编号	R2006.15.2			SH255-12 Kawasaki KLT250 Police Prairie 1983 1984 1985
产品单重	135克			
检测程序	215			
电线插头	20CM小线			
内盒尺寸	100*85*30MM			
外箱尺寸	49.5*25.5*30.5CM			
输出电压	14.5±0.5V 25安培			
一箱只数	50			
铝壳尺寸				
重要说明				
产品编号	R2006.16			31700-358-003 31700-358-013 31700-358-305 Honda CB CL Scrambler 360 1974-1977 Honda CL 360 Scrambler 1974-1976
产品单重	135克			
检测程序	215			
电线插头	25CM小线			
内盒尺寸	100*85*30MM			
外箱尺寸	49.5*25.5*30.5CM			
输出电压	14.5±0.5V			
一箱只数	50			
铝壳尺寸				
重要说明				
产品编号	R2006.17			Kymco - 31600-LCD3-C00 Kymco Agility RS Naked 50 2010 2013 31600-LCD3-E00 Kymco Agility R16 125 2008 2013 31600-LCD3-E00 Kymco Agility RS 125 2009 2010 31600-LCD3-E00 Kymco Agility RS 50 2009 2012 31600-LCD3-E00 Kymco Agility R16 150 2008 2010 31600-LCD3-E00
产品单重	135克			
检测程序	215 2523			
电线插头	20CM小线			
内盒尺寸	100*85*30MM			
外箱尺寸	49.5*25.5*30.5CM			
输出电压	14.5±0.5V 12安培			
一箱只数	50			
铝壳尺寸	黑色铝壳			
重要说明	1黄1粉红是交流 1红正1绿负1黑检测			
产品编号	R2006.17A			Kymco - 31600-LCD3-C00 Kymco Agility RS Naked 50 2010 2013 31600-LCD3-E00 Kymco Agility R16 125 2008 2013 31600-LCD3-E00 Kymco Agility RS 125 2009 2010 31600-LCD3-E00 Kymco Agility RS 50 2009 2012 31600-LCD3-E00 Kymco Agility R16 150 2008 2010 31600-LCD3-E00
产品单重	135克			
检测程序	215 2523			
电线插头	20CM小线			
内盒尺寸	100*85*30MM			
外箱尺寸	49.5*25.5*30.5CM			
输出电压	14.5±0.5V 12安培			
一箱只数	50			
铝壳尺寸	白色铝壳			
重要说明	1黄1粉红是交流 1红正1绿负1黑检测			

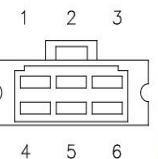

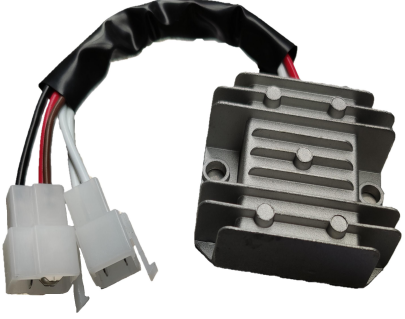
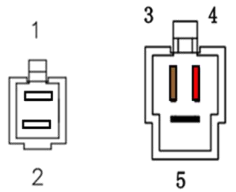

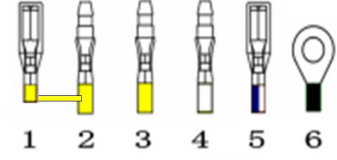
产品资料1		实物主图	接口图	适用范围
产品编号	R2006.17B		 <p>1. Power Coil 2. Power Coil 3. Battery (+) 4. GND 5. Ignition Switch</p>	31600-BA5-9000. Daelim VL125, VC125, VS125 
产品单重	135克			
检测程序	215			
电线插头	20CM小线			
内盒尺寸	100*85*30MM			
外箱尺寸	49.5*25.5*30.5CM			
输出电压	14.5±0.5V 12安培			
一箱只数	50			
铝壳尺寸	白色铝壳T 白色插头			
重要说明	1黄1粉红是交流 1红正1绿负1黑检测			
产品编号	R2006.18		 <p>1. Power Coil / Bobina de Carga 2. Power Coil / Bobina de Carga 3. GND / Masa 4. Ignition Switch/ Sensor 5. Battery (+) / Bateria (+)</p>	HONDA ATV TRX200 FOURTRAX 1990-1991 HONDA ATV TRX200D FOURTRAX 1991-1997
产品单重	135克			
检测程序	215			
电线插头	20CM小线			
内盒尺寸	100*85*30MM			
外箱尺寸	49.5*25.5*30.5CM			
输出电压	14.5±0.5V			
一箱只数	50			
铝壳尺寸				
重要说明				
产品编号	R2006.19		 <p>1. Battery (+) 2. GND 3. Power Coil 4. Power Coil</p>	Honda C100 Super Cub - 1959-1962 Honda CA100 Honda 50 - 1962-1970 Honda CA100T Trail 50 - 1961-1962 Honda C102 Super Cub - 1960-1962 Honda CA102 Honda 50 - 1962-1969 Honda C110 Super Sports Cub - 1960-1962 Honda CA110 Sport 50 - 1962-1969 Honda MR50K Elsinore - 1974-1975 Honda QA50K - 1970-1975 Honda Z50A Mini Trail - 1968-1978
产品单重	135克			
检测程序	215			
电线插头	15CM 配25CM绿线要打端子			
内盒尺寸	100*85*30MM			
外箱尺寸	49.5*25.5*30.5CM			
输出电压	14.5±0.5V			
一箱只数	50			
铝壳尺寸				
重要说明	成品要配对插			
产品编号	R2006.20			31600-LLB1-E00 KYMCO All-Terrain Vehicle (ATV) Mxer 125 2002 125cc KYMCO All-Terrain Vehicle (ATV) Mxer 125 2003 125cc KYMCO All-Terrain Vehicle (ATV) Mxer 125 2004 125cc KYMCO All-Terrain Vehicle (ATV) Mxer 125 2005 125cc KYMCO All-Terrain Vehicle (ATV) Mxer 125 2006 125cc KYMCO All-Terrain Vehicle (ATV) Mxer 125 2007 125cc KYMCO All-Terrain Vehicle (ATV) Mxer
产品单重	135克			
检测程序	215			
电线插头	20CM小线			
内盒尺寸	100*85*30MM			
外箱尺寸	49.5*25.5*30.5CM			
输出电压	14.5±0.5V			
一箱只数	50			
铝壳尺寸				
重要说明				

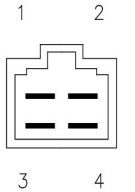

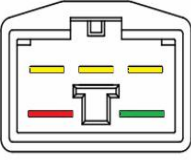

产品资料1		实物主图	接口图	适用范围
产品编号	R2006.21			6H0-81960-00 6AH-81960-00
产品单重	135克			
检测程序	215			
电线插头	20 黑线60CM			
内盒尺寸	100*85*30MM			
外箱尺寸	49.5*25.5*30.5CM			
输出电压	14.5±0.5V			
一箱只数	50			
铝壳尺寸				
重要说明				
产品编号	R2006.22		 <ul style="list-style-type: none"> 1. Power Coil / Bobina de Carga 2. GND / Masa 3. Battery (+) / Bateria (+) 4. Power Coil / Bobina de Carga 	Yamaha - 54B-H1960-00 Yamaha FZ 16 160 2012 2015 54B-H1960-01 Yamaha MW Tricity 125 2014 2016 54B-H1960-01 Yamaha MW Try tik 125 2014 2016 54B-H1960-01
产品单重	135克			
检测程序	215 2521			
电线插头	4针插头			
内盒尺寸	100*85*30MM			
外箱尺寸	49.5*25.5*30.5CM			
输出电压	14.5±0.5V 20安培			
一箱只数	50			
铝壳尺寸				
重要说明				
产品编号	R2006.23		 <ul style="list-style-type: none"> 1. Power Coil / Bobina de Carga 2. Power Coil / Bobina de Carga 3. Power Coil / Bobina de Carga 4. Battery (+) / Bateria (+) 5. Battery (-) / Bateria (-) 6. GND / Masa 	2054 12A Gilera QM 2B 4T 125
产品单重	135克			
检测程序	315 2050			
电线插头	25 CM			
内盒尺寸	100*85*30MM			
外箱尺寸	49.5*25.5*30.5CM			
输出电压	14.5±0.5V 12安培			
一箱只数	50			
铝壳尺寸				
重要说明				
产品编号	R2006.24		 <ul style="list-style-type: none"> 1. Ignition Switch / Sensor 2. GND / Masa 3. Power Coil / Bobina de Carga 4. GND / Masa 5. Battery (+) / Bateria (+) 6. Power Coil / Bobina de Carga 	Go-kart 150 cc 6.000.124-GTS
产品单重	130克净重			
检测程序	215			
电线插头	25CM 有一条绿线48CM不经过整流器			
内盒尺寸	100*85*30MM			
外箱尺寸	49.5*25.5*30.5CM			
输出电压	14.5±0.5V 20安培			
一箱只数	50			
铝壳尺寸	有一条绿线直接 从2 连接到4			
重要说明	1粉红1黄交流 4号针有2 条绿线合并			

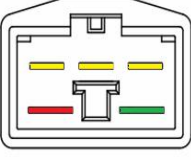

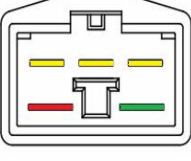
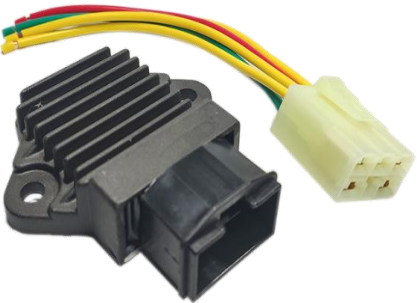
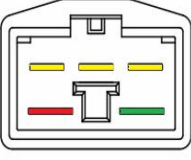

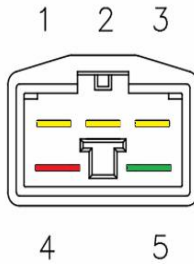

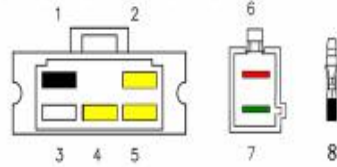
产品资料1		实物主图	接口图	适用范围
产品编号	R2006.25		 <p>1. Ignition Switch / Sensor 2. Power Coil / Bobina de Carga 3. GND/ Masa 4. Battery (+) / Bateria (+)</p> <p>5. Power Coil / Bobina de Carga 6. Power Coil / Bobina de Carga 7. Power Coil / Bobina de Carga</p>	2495 Kawasaki KZ A1/A2/B2/A3 1300 1979 1981 21066-1007 Kawasaki KZ B2 Touring 1300 1980 Reem lazo Shin ngen SH530-12
产品单重	135克			
检测程序	315 2495			
电线插头	25CM 有一条绿线48CM不经过整流器			
内盒尺寸	100*85*30MM			
外箱尺寸	49.5*25.5*30.5CM			
输出电压	14.5±0.5V 35安培			
一箱只数	50			
铝壳尺寸				
重要说明				
产品编号	R2006.26			32800-94620 Suzuki DT Suzuki DF4 2002-2015 Suzuki DF5 2002-2015 Suzuki DF6 2003-2015 Suzuki DF9.9 1996-2004 Suzuki DF15 1996-2004 Suzuki DT50 1992-1993 Suzuki DT55 1991-1993 Suzuki DT60 1994-2000 Suzuki DT65 1991-1993 Suzuki DT90 1994-2000
产品单重	105克 净重90克			
检测程序	半波 HS08			
电线插头	20CM			
内盒尺寸	100*85*30MM			
外箱尺寸	49.5*25.5*30.5CM			
输出电压	14.5±0.5V			
一箱只数	50			
铝壳尺寸				
重要说明				
产品编号	R2006.27			Honda 31700-102-701 (1969-1973 K1-K4 CT 90) 31700-033-000 CT 90 CT200 CM90 31700-259-020
产品单重	135克			
检测程序	215			
电线插头	25CM 小线			
内盒尺寸	100*85*30MM			
外箱尺寸	49.5*25.5*30.5CM			
输出电压	14.5±0.5V			
一箱只数	50			
铝壳尺寸				
重要说明				
产品编号	R2006.28		 <p>1. Ignition Switch / Sensor 2. Battery (+) / Bateria (+) 3. GND / Masa 4. Power Coil / Bobina de Carga 5. Power Coil / Bobina de Carga 6. Power Coil / Bobina de Carga</p>	2068 25A Kawasaki - 21066-1028 Kawasaki BJ Estrella 250 1994 21066-1030 Kawasaki EL Eliminator 250 1988 2003 21066-1030 Kawasaki EL HS 250 1991 1994 21066-1030 Kawasaki EN LTD 454 1985 1990 21066-1030 Kawasaki EN Vulcan 400 1989 1994
产品单重	250克			
检测程序	315 2077 2068			
电线插头	20CM 要白色铝壳			
内盒尺寸	12*9.5*6CM			
外箱尺寸	49.5*25.5*30.5CM			
输出电压	14.5±0.5V 25安培			
一箱只数	50			
铝壳尺寸				
重要说明	3黄1红正1棕是检测线1黑线负极			

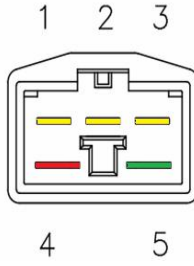
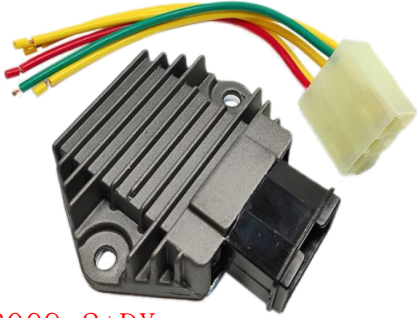
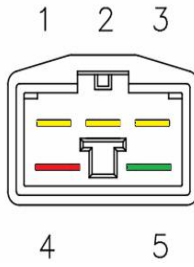
产品资料1		实物主图	接口图	适用范围
产品编号	R2006.29		 <p>1. 交流 AC 2. 交流 AC 3. 检测 (+) 4. 正极 (+) 5. 负极 (-)</p>	Yamaha SR250G SR250 1980 Yamaha SR250TH SR250 1981 Yamaha SR250H SR250 1981 Yamaha SR250J SR250 1982 Yamaha SR250 SR250 Classic 1991-2000 Yamaha XT550 1982-1983
产品单重	净重115克			
检测程序	215 2077 2068			
电线插头	20CM 要白色铝壳			
内盒尺寸	12*9.5*6CM			
外箱尺寸	49.5*25.5*30.5CM			
输出电压	14.5±0.5V 25安培			
一箱只数	50			
铝壳尺寸				
重要说明	2白线1红正1黑负1棕检测			
产品编号	R2006.30			Kymco Agility 50 R16 125 150 Super 8 Hipster Like 50 / LX 125 Personen S/S DD
产品单重	净重115克			
检测程序	215+HS08			
电线插头	20CM			
内盒尺寸	12*9.5*6CM			
外箱尺寸	49.5*25.5*30.5CM			
输出电压	14.5±0.5V			
一箱只数	50			
铝壳尺寸				
重要说明	2白线1红正1黑负1棕检测			
产品编号	R2006.31		 <p>1. AC Power Coil 1是AC输出 2. AC Power Coil 3. AC Power Coil 4. Battery (+) 5. Battery (+) 6. Battery (-)</p>	Honda 25 30 HP 31750-ZW2-F93 SH598C-12 Honda 50 HP 4 Stroke Rectifier And Regulator PN 31600-ZV5-003 Fits Pre 1997-2006
产品单重				
检测程序	208			
电线插头	黑极15白线25黄线和灰/白线32CM			
内盒尺寸	12*9.5*6CM			
外箱尺寸	49.5*25.5*30.5CM			
输出电压	14.5±0.5V			
一箱只数	50			
铝壳尺寸	1号线应该是交流输出			
重要说明	黑白线是指示灯线,白线正 黑线负			
产品编号	R2007.0		 <p>1. Power Coil / Bobina de Carga 2. Power Coil / Bobina de Carga 3. Power Coil / Bobina de Carga 4. Battery (+) / Bateria (+) GND/ Masa: Case/Carcaza</p>	2383 rbi G R 2T 125 00M12502316 Kawasaki BN Eliminator 125 2001 2009 21066-1108 Kawasaki KL Su er Sher a 250 2000 2010 21066-1108 Reem lazo Shin ngen SH629A-12 Yamaha FZR 600 1990 1993 3TJ-81960- 02-00 Yamaha RD LCF 350 1986 3TJ-81960-02- 00
产品单重	130克			
检测程序	308 2383			
电线插头	4针插头			
内盒尺寸	100*85*30MM			
外箱尺寸	49.5*25.5*30.5CM			
输出电压	14.5±0.5V 35安培			
一箱只数	50			
铝壳尺寸				
重要说明	外壳负极 注意插头生产时可能漏胶			

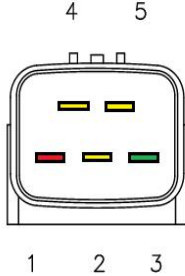

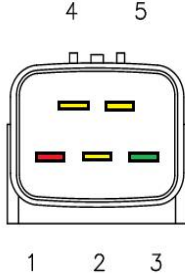

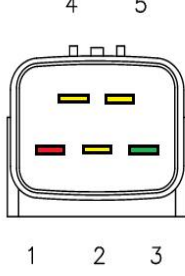

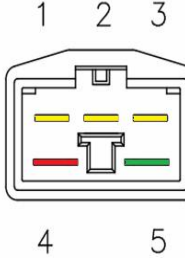
产品资料1		实物主图	接口图	适用范围
产品编号	R2007A.1		 <ol style="list-style-type: none"> 1. Battery (+) / Bateria (+) 2. GND / Masa 3. Power Coil / Bobina de Carga 4. Power Coil / Bobina de Carga 5. Power Coil / Bobina de Carga 	Can-Am DS 450 2008-2015 710000803 彪巴迪
产品单重	180克			
检测程序	M325			
电线插头	6插只用5针			
内盒尺寸	100*85*30MM			
外箱尺寸	49.5*25.5*30.5CM			
输出电压	14.5±0.5V			
一箱只数	50			
铝壳尺寸				
重要说明				
产品编号	R2008.0		 <ol style="list-style-type: none"> 1. Battery (+) / Bateria (+) 2. Power Coil / Bobina de Carga 3. Power Coil / Bobina de Carga 4. Power Coil / Bobina de Carga <p>GND / Masa : Case / Carcasa</p>	Yamaha VMX V-max 1200 1985 1995 42X-81960-A1-00 SH569A-12 Yamaha XV Virago 750 1988 1996 42X-81960-A1-00 Yamaha XV Virago 1000 1984 1985 42X-81960-A1-00 Yamaha XV Virago 1100 1986 1996 42X-81960-A1-00 Yamaha XV Virago 535 1987 1996 42X-81960-A1-00 Yamaha XV Virago 700 1984 1987 42X-
产品单重	120克			
检测程序	308 2526			
电线插头	35CM			
内盒尺寸	100*85*30MM			
外箱尺寸	49.5*25.5*30.5CM			
输出电压	14.5±0.5V 35安培			
一箱只数	100			
铝壳尺寸				
重要说明	外壳负极			
产品编号	R2008.1		 <ol style="list-style-type: none"> 1. Power Coil / Bobina de Carga 2. Power Coil / Bobina de Carga 3. Power Coil / Bobina de Carga 4. Battery (+) / Bateria (+) <p>GND / Masa: Case / Carcasa</p>	2483 Yamaha FZR 600 1989 1994 47X-81960-A2-00 Yamaha FZR 400 1988 1990 47X-81960-A2-00 Yamaha TW Trailway 200 1988 1997 47X-81960-A2-00 Yamaha TW Trailway 200 1998 2000 47X-81960-A3-00 Yamaha XC 125 1994 1999 3KW-H1960-03-00
产品单重	95克			
检测程序	308 2483			
电线插头	4针插头			
内盒尺寸	100*85*30MM			
外箱尺寸	49.5*25.5*30.5CM			
输出电压	14.5±0.5V 35安培			
一箱只数	100			
铝壳尺寸	注意插头是小孔口并和胶在一个平面			
重要说明	外壳负极 注意插头生产时可能漏胶			
产品编号	R2008B.1		 <ol style="list-style-type: none"> 1. GND / Masa 2. Battery (+) / Bateria (+) 3. Power Coil / Bobina de Carga 4. Power Coil / Bobina de Carga 5. Power Coil / Bobina de Carga 	Reem lazo Shindengen SH662-12 Yamaha 3JP-81960-00 Yamaha VMX V-max 1200 de 1996 a 2007 3JP-81960-01
产品单重				
检测程序	M325 2627			
电线插头	1. 5X35CM			
内盒尺寸	100*85*30MM			
外箱尺寸	49.5*25.5*30.5CM			
输出电压	14.5±0.5V 35安培			
一箱只数	50			
铝壳尺寸				
重要说明				



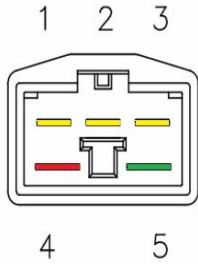

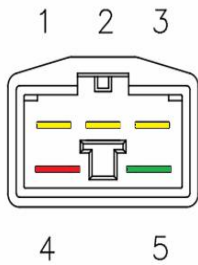

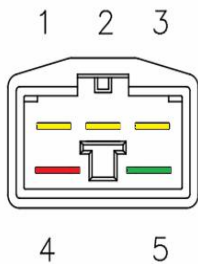
产品资料1		实物主图	接口图	适用范围
产品编号	R2009.0		 <p>1 2 3 4 5</p> <p>1. Power Coil 2. Power Coil 3. Power Coil 4. Battery (+) 5. GND</p>	Honda CB S 600 2004 2007 31600-KFG-861 Honda CB F 600 2004 31600-KFG-861 Honda CB F 400 1989 1990 31600-KY2-702 Honda CB Nighthawk A/AC 250 1991 2000 31600-KBG-008 Honda CB HORNET 600 1998 2006 31600-KFG-861 Honda CBR F2/F3/F4 600 1991 2000 31600-MV4-010
产品单重	115克			
检测程序	308			
电线插头				
内盒尺寸	100*85*30MM			
外箱尺寸	49.5*25.5*30.5CM			
输出电压	14.5±0.5V			
一箱只数	50			
铝壳尺寸				
重要说明				
产品编号	R2009.0M		 <p>1 2 3 4 5</p> <p>1. Power Coil 2. Power Coil 3. Power Coil 4. Battery (+) 5. GND</p>	2600 MOSFET 35A Honda-31600-K J-670 Honda-31600-KY2-702 Honda-31600-KY2-703 Honda-31600-MV4-000 Honda-31600-KBG-008 HondaCB500 1994 200231600-MV4-010 HondaCBS Hornet600 2001 200331600-MV4-010 HondaCB250 1991 200731600-MV4-010 HondaCBF400 1989 199031600-MV4-010
产品单重	115克			
检测程序	M325 2600			
电线插头				
内盒尺寸	100*85*30MM			
外箱尺寸	49.5*25.5*30.5CM			
输出电压	14.5±0.5V MOSFET 35安培			
一箱只数	50			
铝壳尺寸				
重要说明				
产品编号	R2009.0+D		 <p>1 2 3 4 5</p> <p>1. Power Coil 2. Power Coil 3. Power Coil 4. Battery (+) 5. GND</p>	2009.0 对插 Honda CBR CB VT VTR NSR RVF VFR XL NT
产品单重	135克			
检测程序	308/M325			
电线插头				
内盒尺寸	100*85*30MM			
外箱尺寸	49.5*25.5*30.5CM			
输出电压	14.5±0.5V			
一箱只数	50			
铝壳尺寸				
重要说明	配 4 针对插			
产品编号	R2009.0+DX		 <p>1 2 3 4 5</p> <p>1. Power Coil 2. Power Coil 3. Power Coil 4. Battery (+) 5. GND</p>	Honda CB250 Two Fifty 1991-2008 Honda CB400 VTEC Honda CB500 Honda CB600 Hornet600 1998-2006 Honda CBR900 1993-1999 Honda CBR1100XX 1998-2000 Honda VT250 S ADA MC20 Honda C800 1989-1998 Honda NT400 Bros 400 NC25 Honda VT250 Magna250 Honda FES250 esight250
产品单重	135克			
检测程序	308/M325			
电线插头	对插的电线长度 15CM			
内盒尺寸	100*85*30MM			
外箱尺寸	49.5*25.5*30.5CM			
输出电压	14.5±0.5V			
一箱只数	50			
铝壳尺寸				
重要说明	配对手地带线的			

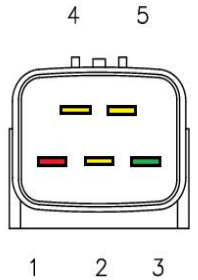
产品资料1		实物主图	接口图	适用范围								
产品编号	R2009.1		 <p>1. Power Coil 2. Power Coil 3. Power Coil 4. Battery (+) 5. GND</p>	Aprilia RXV 450 A 9100424 Aprilia RXV 550 A 9100424 Aprilia SXV 450 A 9100424 Aprilia SXV 550 A 9100424 Honda CB F A/C 400 1989 1990 31600-MV4-000 Honda CB 500 1993 2003 31600-MV4-000 Honda CB A/AC 250 1991 2007 31600-MV4-000 Honda NSS AC 250 2001 2003 31600-								
产品单重	110克											
检测程序	308											
电线插头												
内盒尺寸	100*85*30MM											
外箱尺寸	49.5*25.5*30.5CM											
输出电压	14.5±0.5V											
一箱只数	50											
铝壳尺寸												
重要说明												
产品编号	R2009.1A		 <table border="1"> <tr> <td>1. Ignition Switch / 检测线</td> <td>2. Power Coil / 交流输入</td> </tr> <tr> <td>3. Field Coil / 检测线圈</td> <td>4. Power Coil / 交流输入</td> </tr> <tr> <td>5. Power Coil / 交流输入</td> <td>6. Battery (+) / 正极输出</td> </tr> <tr> <td>7. GND (-) / 负极输出</td> <td>8. Ignition Switch / 检测线</td> </tr> </table>	1. Ignition Switch / 检测线	2. Power Coil / 交流输入	3. Field Coil / 检测线圈	4. Power Coil / 交流输入	5. Power Coil / 交流输入	6. Battery (+) / 正极输出	7. GND (-) / 负极输出	8. Ignition Switch / 检测线	SH258C-12 Honda CBR1000F 1986-1988
1. Ignition Switch / 检测线	2. Power Coil / 交流输入											
3. Field Coil / 检测线圈	4. Power Coil / 交流输入											
5. Power Coil / 交流输入	6. Battery (+) / 正极输出											
7. GND (-) / 负极输出	8. Ignition Switch / 检测线											
产品单重	净重163克											
检测程序	CB750+励磁											
电线插头	15 35CM											
内盒尺寸	100*85*30MM											
外箱尺寸	49.5*25.5*30.5CM											
输出电压	14.5±0.5V											
一箱只数	50											
铝壳尺寸												
重要说明	白线 是 励磁线											
产品编号	R2009.2		 <p>1. Power Coil 2. Power Coil 3. Power Coil 4. Battery (+) 5. GND</p>	2344 35A Honda CB HORNET 600 1998 2006 31600-KFG-861 Honda CB F 600 2004 31600-KFG-861 Honda CB F 400 1989 1990 31600-KY2-702 Honda CB Nighthawk A/AC 250 1991 2000 31600-KBG-008 Honda CB S 600 2004 2007 31600-KFG-861 Honda CBR F2/F3/F4 600 1991 2000								
产品单重	160克											
检测程序	315 2344											
电线插头												
内盒尺寸	100*85*30MM											
外箱尺寸	49.5*25.5*30.5CM											
输出电压	14.5±0.5V 35安培											
一箱只数	50											
铝壳尺寸												
重要说明												
产品编号	R2009.2+DX		 <p>1. Power Coil 2. Power Coil 3. Power Coil 4. Battery (+) 5. GND</p>	Honda CB250 Two Fifty 1991-2008 Honda CB250 Hornet 250 Honda CB-1 (CB400F) Honda CB400 SF Honda CB400 VTEC Honda CB500 Honda CB600 Hornet600 1998-2006 Honda CB600 2004-2006 Honda CBF500 2004-2008 Honda CBF600 2004-2007 Honda CBR250 MC17 MC19MC22								
产品单重	160克											
检测程序	315											
电线插头	对插的电线长度 15CM											
内盒尺寸	100*85*30MM											
外箱尺寸	49.5*25.5*30.5CM											
输出电压	14.5±0.5V											
一箱只数	50											
铝壳尺寸												
重要说明												

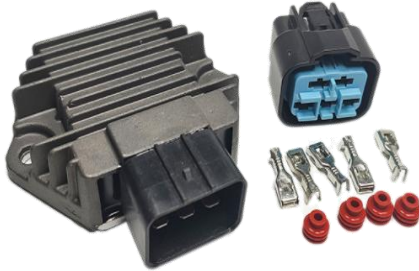
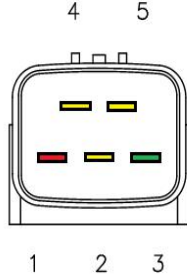

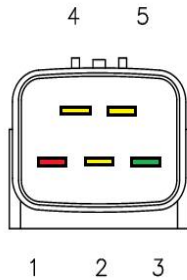

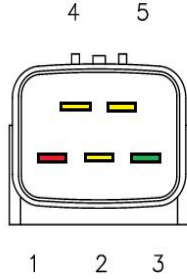

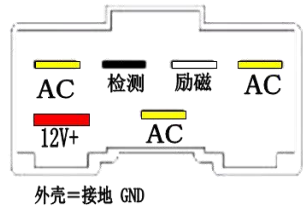
产品资料1		实物主图	接口图	适用范围
产品编号	R2009.3		 <ol style="list-style-type: none"> 1. Battery (+) 2. Power Coil 3. GND 4. Power Coil 5. Power Coil 	2446 SH683AA HondaTRXeman450 1998 200131600-HN5-671 HondaTRXFE / FM / TE / TM350 2000 200331600-HN5-671 HondaTRXFW400 1995 200331600-HN5-671 HondaTRXR / ER450 2004 200931600-HN5-671 HondaTRXS / ES450 1998 200031600-HM7-003 HondaTRXXX700 2007 200931600-HP6-A01
产品单重	175克			
检测程序	315 2446			
电线插头				
内盒尺寸	100*85*30MM			
外箱尺寸	49.5*25.5*30.5CM			
输出电压	14.5±0.5V 35安培			
一箱只数	50			
铝壳尺寸				
重要说明				
产品编号	R2009.3.1		 <ol style="list-style-type: none"> 1. Battery (+) 2. Power Coil 3. GND 4. Power Coil 5. Power Coil 	2446 HondaTRXeman450 1998 200131600-HN5-671 HondaTRXFE / FM / TE / TM350 2000 200331600-HN5-671 HondaTRXFW400 1995 200331600-HN5-671 HondaTRXR / ER450 2004 200931600-HN5-671 HondaTRXS / ES450 1998 200031600-HM7-003 HondaTRXXX700 2007 200931600-HP6-A01
产品单重	175克			
检测程序	315 2446			
电线插头				
内盒尺寸	100*85*30MM			
外箱尺寸	49.5*25.5*30.5CM			
输出电压	14.5±0.5V 35安培			
一箱只数	50			
铝壳尺寸				
重要说明				
产品编号	R2009.3.1+D		 <ol style="list-style-type: none"> 1. Battery (+) 2. Power Coil 3. GND 4. Power Coil 5. Power Coil 	YHC/SKU485693/ Application: 31600-HN5-671 巴西MAG-D -209 赤色五孔插头250整流器 SH683CA HONDA TRX400FW eman 1995 96 97 98 99 00 01 02 03 HONDA TRX350 TE Rancher ES 2000 01 02 03 04 05 06 HONDA TRX350 TM Rancher S 2000 01 02 03 04 05 06 HONDA TRX350 FM Rancher 4x4 S 2000 01
产品单重	配对插带包装200克/只			
检测程序	315			
电线插头				
内盒尺寸	100*85*30MM			
外箱尺寸	49.5*25.5*30.5CM			
输出电压	14.5±0.5V			
一箱只数	50			
铝壳尺寸				
重要说明				
产品编号	R2009.4		 <ol style="list-style-type: none"> 1. Power Coil 2. Power Coil 3. Power Coil 4. Battery (+) 5. GND 	2355 Aprilia RXV 450 2005 2012 A 9100424 Aprilia RXV 550 2005 2012 A 9100424 Aprilia SXV 550 2005 2012 A 9100424 Aprilia SXV 450 2005 2012 A 9100424 Ducati - 434 40 0300 Honda CB S 400 2004 2007 31600-KFG-
产品单重	单重/克175克			
检测程序	315 2355			
电线插头				
内盒尺寸	100*85*30MM			
外箱尺寸	49.5*25.5*30.5CM			
输出电压	14.5±0.5V 35安培			
一箱只数	50			
铝壳尺寸				
重要说明				



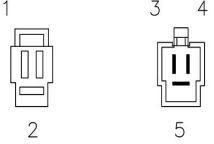

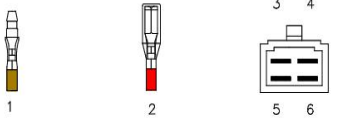

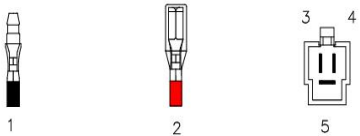
产品资料1		实物主图	接口图	适用范围
产品编号	R2009.4.1		 <p>1. Field Coil / Bobina de Campo 2. Ignition Switch / Sensor 3. Power Coil / Bobina de Carga 4. Power Coil / Bobina de Carga 5. Power Coil / Bobina de Carga 6. GND / Masa 7. Battery (+) / Bateria (+) 8. Ignition Switch / Sensor</p>	2335 25A CAM 0 - Honda CB 650 1981 1982 31600-460-731 Honda CB 650 1979 1980 31600-426-000 Honda CBX F/F2 750 1984 1986 31600-MJO-612 Honda CBX /F 400 1985 31600-MJO-612
产品单重	200克			
检测程序	CB750+励磁 2335			
电线插头	25CM			
内盒尺寸	12*9.5*6CM			
外箱尺寸	49.5*25.5*30.5CM			
输出电压	14.5±0.5V 25安培			
一箱只数	50			
铝壳尺寸				
重要说明	白线 是 励磁线			
产品编号	R2009.4.2		 <p>1. Power Coil / Bobina de Carga (Yellow/ Amarillo) 2. Power Coil / Bobina de Carga (Yellow/ Amarillo) 3. Charge Lamp/ Lámpara Piloto 4. Battery (+) / Bateria (+) (Red/ Rojo) 5. GND/ Masa (Green/Verde)</p>	Moto Guzzi - Ducati Ducati 748 1997 Ducati 750 aso from 1987 to 2001 Ducati 750 S ort from 1987 to 2001 Ducati 750 FI from 1987 to 2001 Ducati 750 SS from 1987 to 2001 Ducati 851 from 1990 to 1993 Ducati 888 from 1990 to 1993 Ducati 900 ST2 from 1988 to 1998 Ducati 900 SSR from 1989 to 1993 Ducati 900 Su erlight from 1989 to 2466
产品单重	净重200克			
检测程序	QF2101 新			
电线插头	25 45CM			
内盒尺寸	12*9.5*6CM			
外箱尺寸	49.5*25.5*30.5CM			
输出电压	14.5±0.5V			
一箱只数	50			
铝壳尺寸				
重要说明				
产品编号	R2009.4.3		 <p>1 Yellow / Amarillo: Power Coil / Generator 2 Yellow / Amarillo: Power Coil / Generator 3 Yellow / Amarillo: Power Coil / Generator 4 Green / Verde: Battery (-) / Bateria (-) 5 Red / Rojo: Battery (+) / Bateria (+)</p>	Hyosung GT S / R FI 650 2007 2013 32800HN9101 Hyosung GT /R 250 2008 2013 32800HN9110 Hyosung GT /R FI 250 2010 2013 32800HN9110 Hyosung GV Mirage 650 2007 2013 32800HN9101 Hyosung GV Comet 650 2007 2013 32800HN9101
产品单重	200克			
检测程序	315 2466			
电线插头	25CM			
内盒尺寸	12*9.5*6CM			
外箱尺寸	49.5*25.5*30.5CM			
输出电压	14.5±0.5V 35安培			
一箱只数	50			
铝壳尺寸				
重要说明				
产品编号	R2009.4.4			东南亚 GS500 1995-2009
产品单重	克			
检测程序	315			
电线插头	35CM			
内盒尺寸	12*9.5*6CM			
外箱尺寸	49.5*25.5*30.5CM			
输出电压	14.5±0.5V			
一箱只数	50			
铝壳尺寸				
重要说明	3黑线交流1黑红正1黑白负			

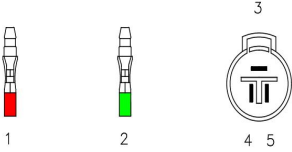
产品资料1		实物主图	接口图	适用范围
产品编号	R2009.5		 <p>1. Power Coil 2. Power Coil 3. Power Coil 4. Battery (+) 5. GND</p>	Marca Mo lo Versión Cilindrada Año Cod. OEM Aprilia RXV 550 2005 2012 A 9100424 Aprilia RXV 450 2005 2012 A 9100424 Aprilia SXV 550 2005 2012 A 9100424 Aprilia SXV 450 2005 2012 A 9100424 Honda CBR OS I NC25 400 31600-KY2-703
产品单重	140克, 15kg/箱			
检测程序	315			
电线插头				
内盒尺寸	100*85*30MM			
外箱尺寸	49.5*25.5*30.5CM			
输出电压	14.5±0.5V			
一箱只数	50			
铝壳尺寸				
重要说明	铝壳内腔 是 厚的			
产品编号	R2009.5+D	 <p>配对插</p>	 <p>1. Power Coil 2. Power Coil 3. Power Coil 4. Battery (+) 5. GND</p>	Honda CB-1 (CB400FM) (NC27) CB250 CB400 CB400F (NC31) CB400SF (NC39) CB500 CB600 CBR1100XX BLACKBIRD CARBURATOR MO L (1996-1999) CBR250
产品单重	140克, 15kg/箱			
检测程序	315			
电线插头				
内盒尺寸	100*85*30MM			
外箱尺寸	49.5*25.5*30.5CM			
输出电压	14.5±0.5V			
一箱只数	50			
铝壳尺寸				
重要说明				
产品编号	R2009.5+DX		 <p>1. Power Coil 2. Power Coil 3. Power Coil 4. Battery (+) 5. GND</p>	Honda CB-1 (CB400FM) (NC27) CB250 CB400 CB400F (NC31) CB400SF (NC39) CB500 CB600 CBR1100XX BLACKBIRD CARBURATOR MO L (1996-1999) CBR250
产品单重	140克, 15kg/箱			
检测程序	315			
电线插头	对插的电线长度 15CM			
内盒尺寸	100*85*30MM			
外箱尺寸	49.5*25.5*30.5CM			
输出电压	14.5±0.5V			
一箱只数	50			
铝壳尺寸				
重要说明				
产品编号	R2009.6		 <p>1. Battery (+) 2. Power Coil 3. GND 4. Power Coil 5. Power Coil</p>	2447 Honda CB 300 2013 2015 31600-HP6-A01 Honda CBF 250 2004 2007 31600-KPF-961 Honda CBX Twister 250 hasta 2016 31600-KPF-961 Honda CRF AC 230 2008 2009 31600-HN5- M40 Honda CRF R 450 2009 2012 31600-MEN- A31 Honda CRF R 250 2010 2012 31600-MEN- A31
产品单重	160克			
检测程序	315 2447 2446			
电线插头				
内盒尺寸	100*85*30MM			
外箱尺寸	49.5*25.5*30.5CM			
输出电压	14.5±0.5V 35安培			
一箱只数	50			
铝壳尺寸				
重要说明				

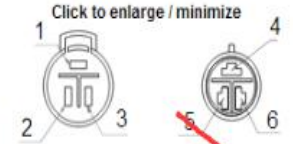
产品资料1		实物主图	接口图	适用范围
产品编号	R2009.6+D		 <p>1. Battery (+) 2. Power Coil 3. GND 4. Power Coil 5. Power Coil</p>	2009.6 配对插
产品单重	200克			
检测程序	315			
电线插头				
内盒尺寸	12*9.5*6CM			
外箱尺寸	49.5*25.5*30.5CM			
输出电压	14.5±0.5V			
一箱只数	50			
铝壳尺寸				
重要说明				
产品编号	R2009.6.1		 <p>1. Battery (+) 2. Power Coil 3. GND 4. Power Coil 5. Power Coil</p>	Honda Aero S irit VT750C VT750C2 VT750CA XLV650(SH683-12), 31600-HN7-003, 31600-HN7-A21 HONDA TRX450S/ES eman 1998 99 00 01 HONDA TRX400FW eman 1995 96 97 98 99 00 01 02 03 HONDA TRX350 TE Rancher ES 2000 01 02 03 04 05 06 HONDA TRX350 TM Rancher S 2000 01 02 03 04 05 06 HONDA TRX350 FM Rancher 4x4 S 2000 01
产品单重	160克, 配对插200克			
检测程序	315			
电线插头				
内盒尺寸	100*85*30MM			
外箱尺寸	49.5*25.5*30.5CM			
输出电压	14.5±0.5V			
一箱只数	50			
铝壳尺寸				
重要说明				
产品编号	R2009.6.2		 <p>1. Battery (+) 2. Power Coil 3. GND 4. Power Coil 5. Power Coil</p>	Honda TRX 350 Rancher FE - 4x4 ES 2001-2003 Honda TRX 350 Rancher FM - 4x4 Manual 2001-2003 Honda TRX 350 Rancher TE - 2x4 ES 2001-2003 Honda TRX 350 Rancher TM - 2x4 Manual 2001-2003 Honda TRX 400 Fourtrax eman FW 1995-2003 Honda TRX 450 Fourtrax eman FE - 4x4
产品单重	160克, 配对插200克			
检测程序	315			
电线插头				
内盒尺寸	12*9.5*6CM			
外箱尺寸	49.5*25.5*30.5CM			
输出电压	14.5±0.5V			
一箱只数	50			
铝壳尺寸				
重要说明				
产品编号	R2009.7		 <p>AC 检测 励磁 AC 12V+ AC 外壳=接地 GND</p>	HONDA STREET BIKE sh261-12 31600-MS2-601 SH261-12 HONDA CBR1000F Hurricane 1990-1991 HONDA CBR1000F Hurricane 1993-1996
产品单重	142克			
检测程序	CB750+励磁			
电线插头	6插+外壳接地负极			
内盒尺寸	100*85*30MM			
外箱尺寸	49.5*25.5*30.5CM			
输出电压	14.5±0.5V			
一箱只数	50			
铝壳尺寸				
重要说明				

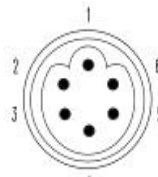

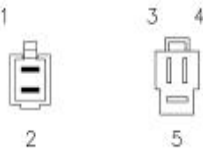

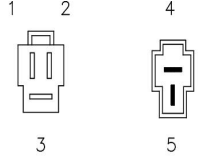
产品资料1		实物主图	接口图	适用范围
产品编号	R2010.0		 <ol style="list-style-type: none"> 1. Battery (+) / Bateria (+) 2. GND / Masa 3. Power Coil / Bobina de Carga 4. Power Coil / Bobina de Carga 5. Power Coil / Bobina de Carga 	Yamaha ATV 5GT-81960-00-00 Bear Tracker YFM250 230cc 2001-04 Big Bear 250 YFM25B 230cc 2006-09 Big Bear 400 YFM40 386cc 2002-12 Bruin 250 YFM250BT 230cc 2005-06 Bruin 350 YFM35 348cc 2004-06 Grizzly 125 YFM125 124cc 2004-13 Grizzly 350 YFM35 348cc 2007-13 Grizzly 400 YFM4FG 401cc 2007-08 Grizzly 450 YFM45FG 421cc 2007-13 Grizzly 600 YFM600 595cc 1999-01
产品单重	150克			
检测程序	315			
电线插头				
内盒尺寸	100*85*30MM			
外箱尺寸	49.5*25.5*30.5CM			
输出电压	14.5±0.5V			
一箱只数	50			
铝壳尺寸				
重要说明				
产品编号	R2010.1		 <ol style="list-style-type: none"> 1. Ignition Switch / Sensor 2. Battery (+) / Bateria (+) 3. GND / Masa 4. Power Coil / Bobina de Carga 5. Power Coil / Bobina de Carga 6. Power Coil / Bobina de Carga 	2068 25A Kawasaki - 21066-1028 Kawasaki BJ Estrella 250 1994 21066-1030 Kawasaki EL Eliminator 250 1988 2003 21066-1030 Kawasaki EL HS 250 1991 1994 21066-1030 Kawasaki EN LTD 454 1985 1990 21066-1030 Kawasaki EN Vulcan 400 1989 1994
产品单重	150克			
检测程序	315 2077 2068			
电线插头	25CM			
内盒尺寸	12*9.5*6CM			
外箱尺寸	49.5*25.5*30.5CM			
输出电压	14.5±0.5V 25安培			
一箱只数	50			
铝壳尺寸				
重要说明	3黄1红正1棕是检测线1黑线负极			
产品编号	R2010.1.1		 <ol style="list-style-type: none"> 1. Battery (+) / Bateria (+) 2. Ignition Switch / Sensor 3. Power Coil / Bobina de Carga 4. GND / Masa 5. Power Coil / Bobina de Carga 	大绵羊整流器
产品单重	150克			
检测程序	315			
电线插头	20CM			
内盒尺寸	12*9.5*6CM			
外箱尺寸	49.5*25.5*30.5CM			
输出电压	14.5±0.5V			
一箱只数	50			
铝壳尺寸				
重要说明				
产品编号	R2010.2		 <ol style="list-style-type: none"> 1. Battery (+) 2. GND 3. Power Coil 4. Power Coil 5. Power Coil 	MBK Skyliner 180 2002 2010 4HM-81960-00 MBK Skyliner 125 2002 2010 4HM-81960-00 MBK Skyliner 150 2002 2010 4HM-81960-00 Suzuki DR SE 650 1996 2017 32800-32E00 Suzuki XF Freewind 650 s 1997 32800-32E00 Yamaha Flame X 125 4HM-81960-00
产品单重	150克 净重135			
检测程序	315			
电线插头	5针插头			
内盒尺寸	100*85*30MM			
外箱尺寸	49.5*25.5*30.5CM			
输出电压	14.5±0.5V			
一箱只数	50			
铝壳尺寸				
重要说明				

产品资料1		实物主图	接口图	适用范围
产品编号	R2010.3		 <p>1. Battery (+) / Batería (+) 2. GND / Masa 3. Power Coil / Bobina de Carga 4. Power Coil / Bobina de Carga 5. Power Coil / Bobina de Carga</p>	Cagiva Ra tor 650 2001 2005 Reem lazo ietcard 1184 Suzuki DR SE 350 1997 1999 32800-14D11 Suzuki DR SE 250 1990 1995 32800-14D10 Suzuki DR SE 350 1990 1996 32800-14D10 Suzuki LS Savage LS650 K1 K2 K3 650 1996 2004 32800-24B01 Suzuki LS Savage LS650 650 1995
产品单重	150克			
检测程序	315 2384			
电线插头	40CM			
内盒尺寸	12*9.5*6CM			
外箱尺寸	49.5*25.5*30.5CM			
输出电压	14.5±0.5V 35安培			
一箱只数	50			
铝壳尺寸				
重要说明	3黄 1红正 1黑线负极			
产品编号	R2010.3.1		 <p>1. Ignition Switch/ Sensor 2. Battery (+) / Batería (+) 3. GND / Masa 4. Power Coil / Bobina de Carga 5. Power Coil / Bobina de Carga 6. Power Coil / Bobina de Carga</p>	2112-0544 Re lacment Regulator Rectifiers Yamaha 250 Timberwolf 4x4 94-96 2112-0544 OEM Re lacment Regulator Rectifiers Yamaha 350 Big Bear 4x4 1995-96 2112-0544
产品单重	150克			
检测程序	315			
电线插头	15CM			
内盒尺寸	12*9.5*6CM			
外箱尺寸	49.5*25.5*30.5CM			
输出电压	14.5±0.5V			
一箱只数	50			
铝壳尺寸				
重要说明				
产品编号	R2010.3.2		 <p>1. GND / Masa 2. Battery (+) / Batería (+) 3. Power Coil / Bobina de Carga 4. Power Coil / Bobina de Carga 5. Power Coil / Bobina de Carga</p>	2112-0543 Regulator Rectifiers Yamaha 250 Timberwolf 4x4 97-00 2112-0543
产品单重	150克			
检测程序	315			
电线插头	15CM			
内盒尺寸	12*9.5*6CM			
外箱尺寸	49.5*25.5*30.5CM			
输出电压	14.5±0.5V			
一箱只数	50			
铝壳尺寸				
重要说明	3白线交流1红正 1黑负			
产品编号	R2010.4		 <p>1. Battery (+) / Batería (+) (Red/ Rojo) 2. GND / Masa (Green/ Verde) 3. Power Coil / Bobina de Carga 4. Power Coil / Bobina de Carga 5. Power Coil / Bobina de Carga</p>	2341 25A HondaTRXFourtrax300 1993 200031600-HC5-970 HondaTRXFourtrax FW300 1993 2000 31600-HC5-970 Reem lazoShin ngenSH532C-13
产品单重	150克			
检测程序	315			
电线插头	20 35CM			
内盒尺寸	12*9.5*6CM			
外箱尺寸	49.5*25.5*30.5CM			
输出电压	14.5±0.5V			
一箱只数	50			
铝壳尺寸				
重要说明				

产品资料1		实物主图	接口图	适用范围
产品编号	R2010.4.2		 <p>Click to enlarge / minimize</p> <p>1.Yellow / Amarillo : Power Coil / Generator 2.Yellow / Amarillo : Power Coil / Generator 3.Yellow / Amarillo : Power Coil / Generator 4.Green / Verde : Battery (-) / Bateria (-) 5.Black / Negro : Sensor / Sensor 6.Red / Rojo : Battery (+) / Bateria (+)</p>	Honda TRX 250 Utility Mo 1 1985 1986 1987 ATV - 1985 Honda ATC250ES - 1985 Honda ATC250SX - 1985 Honda TRX250 Utility Mo 1 - 1986 Honda ATC250ES - 1986 Honda ATC250SX - 1986 Honda TRX250 Utility Mo 1 - 1987 Honda ATC250ES - 1987 Honda ATC251SX 98 1999 2000 r♀-7
产品单重	150克			
检测程序	315			
电线插头	20CM			
内盒尺寸	12*9.5*6CM			
外箱尺寸	49.5*25.5*30.5CM			
输出电压	14.5±0.5V			
一箱只数	50			
铝壳尺寸				
重要说明	3白线交流1红正1黑负			
产品编号	R2010.5		 <p>1. GND / Masa 2. Ignition Switch / Sensor 3. Power Coil / Bobina de Carga 4. Power Coil / Bobina de Carga 5. Power Coil / Bobina de Carga 6. Battery (+) / Bateria (+)</p>	2340 Reem lazoShin ngenSH235 YamahaYFMMoto-4225 1986 198859V- 81960-A0-00 YamahaYFMMoto-4250 1989 199159V- 81960-A0-00 YamahaYFMFW350 1987 198959V-81960- A0-00 YamahaYFMBig Bear F350 1990 199459V- 81960-A0-00 YamahaYFMWarrior X350 1987 199559V-
产品单重	150克			
检测程序	315 2340			
电线插头	15CM			
内盒尺寸	12*9.5*6CM			
外箱尺寸	49.5*25.5*30.5CM			
输出电压	14.5±0.5V 25安培			
一箱只数	50			
铝壳尺寸				
重要说明	3白交流1红正 1黑负1棕检测			
产品编号	R2010.6		 <p>1. Battery (+) / Bateria (+) 2. GND / Masa 3. Power Coil / Bobina de Carga 4. Power Coil / Bobina de Carga 5. Power Coil / Bobina de Carga</p>	KTM 400 450 620 625 640 KTM 400 LC4 1998-2001 KTM 400 RXC 1998 KTM 620 RXC 1998 KTM 625 SMC 2003-2006 KTM 640 Adventure/Su ermoto 1999- 2007 KTM 660 Enduro 2005 32800-45C01 Suzuki VZ 800 Marau r 1997-2004
产品单重	150克			
检测程序	315			
电线插头	20CM 白线45CM			
内盒尺寸	12*9.5*6CM			
外箱尺寸	49.5*25.5*30.5CM			
输出电压	14.5±0.5V			
一箱只数	50			
铝壳尺寸				
重要说明	3白1红1黑			
产品编号	R2010.7		 <p>1. Power Coil / Bobina de Carga 2. Power Coil / Bobina de Carga 3. Power Coil / Bobina de Carga 4. GND / Masa 5. Battery (+) / Bateria (+)</p>	SUZUKI GS500F GS 500 F 2004-2009
产品单重	150克			
检测程序	315			
电线插头	30CM			
内盒尺寸	100*85*30MM			
外箱尺寸	49.5*25.5*30.5CM			
输出电压	14.5±0.5V			
一箱只数	50			
铝壳尺寸				
重要说明	3黑线交流1黑红正1黑白负			

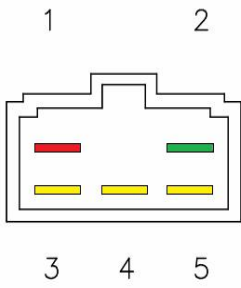

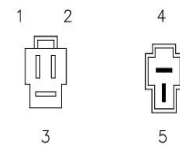
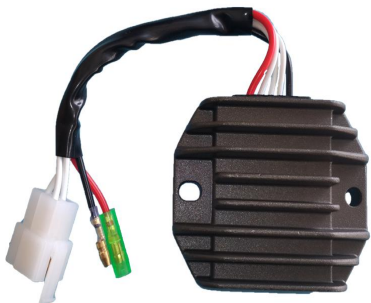
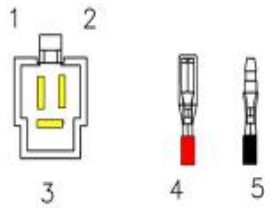

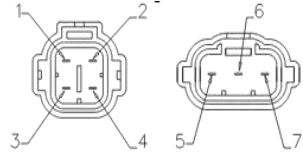
产品资料1		实物主图	接口图	适用范围
产品编号	R2010.8		 <p>1. Ignition Switch / Sensor 2. Battery (+) / Batería (+) 3. Charge Lamp 4. GND / Masa 5. Power Coil / Bobina de Carga 6. Power Coil / Bobina de Carga 7. Power Coil / Bobina de Carga</p>	猎鹰150, 配套11组线圈专用7线稳压器 增光整流器 2 种插头 白线是增光的, 电压13V, 电瓶断路或没电瓶 大灯还是可以用, 如果 电瓶短路大灯就不能用了。
产品单重	150克			
检测程序	315			
电线插头	20CM			
内盒尺寸	12*9.5*6CM			
外箱尺寸	49.5*25.5*30.5CM			
输出电压	14.5±0.5V			
一箱只数	50		 <p>1. Ignition Switch / Sensor 2. Battery (+) / Batería (+) 3. GND / Masa 4. Power Coil / Bobina de Carga 5. Power Coil / Bobina de Carga 6. Power Coil / Bobina de Carga 7. Charge Lamp</p>	猎鹰150, 配套11组线圈专用7线稳压器 增光整流器 2 种插头 白线是增光的, 电压13V, 电瓶断路或没电瓶 大灯还是可以用, 如果 电瓶短路大灯就不能用了。
重要说明				
产品编号	R2010.9			
产品单重	150克			
检测程序	315			
电线插头	25CM			
内盒尺寸	12*9.5*6CM			
外箱尺寸	49.5*25.5*30.5CM			
输出电压	14.5±0.5V			
一箱只数	50		 <p>1. Battery (+) / Batería (+) 2. Battery (+) / Batería (+) 3. GND / Masa 4. GND / Masa 5. Power Coil / Bobina de Carga 6. Power Coil / Bobina de Carga 7. Power Coil / Bobina de Carga</p>	2541 Polaris Outlaw 450 2008 2010 4012536 Polaris Outlaw 500 2006 2007 4012536 Polaris Outlaw S / IRS 525 2007 2011 4012536 Polaris redator 500 2003 2007 4010654
重要说明	7号粉红线大灯正极			
产品编号	R2010.10			
产品单重	150克			
检测程序	325 2454 2541			
电线插头	20CM			
内盒尺寸	12*9.5*6CM			
外箱尺寸	49.5*25.5*30.5CM			
输出电压	14.5±0.5V 35安培		 <p>1. Battery (+) / Batería (+) 2. Power Coil / Bobina de Carga 3. Power Coil / Bobina de Carga 4. Power Coil / Bobina de Carga 5. GND</p>	1988 Suzuki GN250 -- 1985 Suzuki GN250 -- 1983 Suzuki GN250 -- 1982 Suzuki GN250
一箱只数	50			
铝壳尺寸				
重要说明				
产品编号	R2010.11			
产品单重	150克			
检测程序	315			
电线插头	黑线25 白线 和红线是40CM			
内盒尺寸	12*9.5*6CM			
外箱尺寸	49.5*25.5*30.5CM			
输出电压	14.5±0.5V			
一箱只数	50			
铝壳尺寸				
重要说明	3白线交流 1红正 1黑负			





产品资料1		实物主图	接口图	适用范围
产品编号	R2010.12		 <p>1. Battery (+) / Bateria (+) 3. GND / Masa 4. Power Coil / Bobina de Carga 5. Power Coil / Bobina de Carga 6. Power Battery (+) / Bateria (+) arga</p>	Yamaha WR450F, YFZ450
产品单重	150克			
检测程序	315			
电线插头	25CM			
内盒尺寸	12*9.5*6CM			
外箱尺寸	49.5*25.5*30.5CM			
输出电压	14.5±0.5V			
一箱只数	50			
铝壳尺寸				
重要说明				
产品编号	R2010.13			1965 Honda CB160 S ort 1969-1973 Honda CB175 Su er S ort 1974 Honda CB200 -- 1974 Honda CB360 -- 1976 Honda CB360T -- 1975 Honda CB360T -- 1974 Honda CB450 -- 1972-19733 Honda CB450 Su er S ort 1971 Honda CB450 -- 1970 Honda CB450 Su er S ort 1976 Honda CB500T Twin DOHC
产品单重	150克			
检测程序	M325			
电线插头				
内盒尺寸	12*9.5*6CM			
外箱尺寸	49.5*25.5*30.5CM			
输出电压	14.5±0.5V			
一箱只数	50			
铝壳尺寸				
重要说明	要配对插			
产品编号	R2010.14			Honda CB160 - 1964-1969 Honda CB175K - 1969-1973 Honda CL175K Scrambler - 1968-1973 Honda SL175K - 1970-1972 Honda CB200 - 1974 Honda CL200 Scrambler - 1974 Honda CB200T - 1975-1976 Honda CB350K Twin - 1968-1973 Honda CL350K Scrambler - 1968-1973 Honda SL350K Motors ort - 1969-1973 Honda CB360K/G - 1974
产品单重	150克			
检测程序	M325			
电线插头	50CM 单独配25CM的绿线			
内盒尺寸	12*9.5*6CM			
外箱尺寸	49.5*25.5*30.5CM			
输出电压	14.5±0.5V			
一箱只数	50			
铝壳尺寸				
重要说明	配对插			
产品编号	R2011.0		 <p>1. Battery (+) / Bateria (+) 2. GND / Masa 3. Power Coil / Bobina de Carga 4. Power Coil / Bobina de Carga 5. Power Coil / Bobina de Carga</p>	2375 HondaTRXA / AC400 1999 2000 31600-HM8-003 HondaTRXEX / TE / TM250 1997 2005 31600-HM8-013 HondaTRXEX400 1999 200431600-HM8-013 HondaTRXA / AC250 1997 200031600-HM8-003 HondaTRXTE250 2005 200931600-HM8-B00 HondaTRXTE250 2011 201431600-HM8-B00 HondaTRXTE250 2016 201731600-HM8-B00
产品单重	150克			
检测程序	315 2375			
电线插头	6插只用5针			
内盒尺寸	100*85*30MM			
外箱尺寸	49.5*25.5*30.5CM			
输出电压	14.5±0.5V 35安培			
一箱只数	50			
铝壳尺寸				
重要说明				

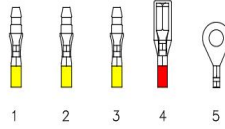

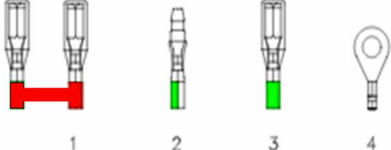
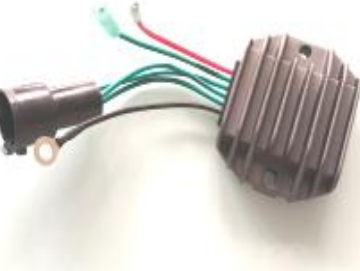
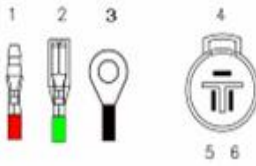

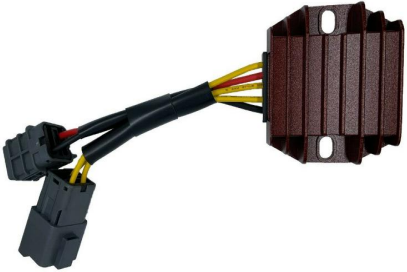

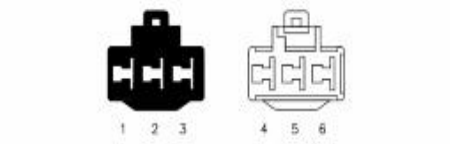
产品资料1		实物主图	接口图	适用范围
产品编号	R2011.1		 <p>1. Battery (+) 2. GND 3. Power Coil 4. Power Coil 5. Power Coil</p>	MBK Skyliner 180 2002 2010 4HM-81960-00 MBK Skyliner 125 2002 2010 4HM-81960-00 MBK Skyliner 150 2002 2010 4HM-81960-00 Suzuki DR SE 650 1996 2017 32800-32E00 Suzuki XF Freewind 650 s 1997 32800-32E00 Yamaha Flame X 125 4HM-81960-00
产品单重	150克			
检测程序	315			
电线插头	5针插头			
内盒尺寸	100*85*30MM			
外箱尺寸	49.5*25.5*30.5CM			
输出电压	14.5±0.5V MOSFET 35安培			
一箱只数	50			
铝壳尺寸				
重要说明				
产品编号	R2011.2		 <p>1. Power Coil / Bobina de Carga 2. Power Coil / Bobina de Carga 3. Power Coil / Bobina de Carga 4. GND / Masa 5. Battery (+) / Bateria (+)</p>	2408 20A Reem lazo Shin ngen SH572MB Suzuki AN 125 2000 32800-22D11 Suzuki AN Burgman 250 1996 2000 32800-22D10 Suzuki AN Burgman 125 1995 2000 32800-22D10 Suzuki EN 125 2004 2008 32800-22D20 Suzuki EN A2 125 32800-37G10-000 Suzuki GN 125 32800-37G10-000 Suzuki GSX 250 1991 1997 32800-
产品单重	150克			
检测程序	315 2396 2408			
电线插头	20CM			
内盒尺寸	12*9.5*6CM			
外箱尺寸	49.5*25.5*30.5CM			
输出电压	14.5±0.5V 25安培			
一箱只数	50			
铝壳尺寸				
重要说明	3黑线交流1红正1绿负			
产品编号	R2011.3		 <p>1. Power Coil / Bobina de Carga 2. Power Coil / Bobina de Carga 3. Power Coil / Bobina de Carga 4. Battery (+) / Bateria (+) 5. GND / Masa</p>	2343 25A Reem lazo ietcard 1376 Yamaha YFB Timberwolf 250 1998 2000 4KB-81960-02 Yamaha YFB250 1997 4KB-81960-01 Yamaha YFB Timberwolf 250 1997 4KB-81960-01 Yamaha YFM Wolverine 350 1996 1997 4KB-81960-01 Yamaha YFM350 1997 4KB-81960-01 Yamaha YFM Grizzly 600 1998 4KB-
产品单重	150克			
检测程序	315 2343			
电线插头	20CM			
内盒尺寸	12*9.5*6CM			
外箱尺寸	49.5*25.5*30.5CM			
输出电压	14.5±0.5V 25安培			
一箱只数	50			
铝壳尺寸				
重要说明	3白线交流1红正1黑负			
产品编号	R2011.4		 <p>1. Battery (+) / Bateria (+) 2. Battery (+) / Bateria (+) 3. Battery (-) / Bateria (-) 4. Battery (-) / Bateria (-) 5. Power Coil / Generado 6. Power Coil / Generado 7. Power Coil / Generado</p>	2541 PolarisOutlaw450 2008 20104012536 PolarisOutlaw500 2006 20074012536 PolarisOutlawS / IRS525 2007 2011 4012536 Polaris redator500 2003 2007 4010654
产品单重	150克			
检测程序	315 2454 2451			
电线插头	20CM			
内盒尺寸	12*9.5*6CM			
外箱尺寸	49.5*25.5*30.5CM			
输出电压	14.5±0.5V 35安培			
一箱只数	50			
铝壳尺寸				
重要说明				

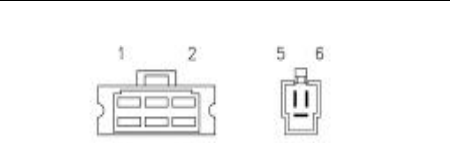

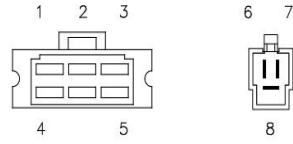

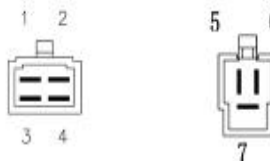
产品资料1		实物主图	接口图	适用范围
产品编号	R2011.5		 <p>1. Battery (+) / Bateria (+) 2. GND / Masa 3. Power Coil / Bobina de Carga 4. Power Coil / Bobina de Carga 5. Power Coil / Bobina de Carga</p>	钱江整流器
产品单重	150克			
检测程序	315			
电线插头	25CM			
内盒尺寸	12*9.5*6CM			
外箱尺寸	49.5*25.5*30.5CM			
输出电压	14.5±0.5V			
一箱只数	50			
铝壳尺寸				
重要说明				
产品编号	R2011.6		 <p>1. Battery (+) / Bateria (+) (Red/Rojo) 2. GND / Masa (Green/Verde) 3. Power Coil / Bobina de Carga 4. Power Coil / Bobina de Carga 5. Power Coil / Bobina de Carga</p>	2341 HondaTRXFourtrax300 1993 200031600- HC5-970 HondaTRXFourtrax FW300 1993 2000 31600-HC5-970 Reem lazoShin ngenSH532C-13
产品单重	150克			
检测程序	315 2341			
电线插头	20 35CM			
内盒尺寸	12*9.5*6CM			
外箱尺寸	49.5*25.5*30.5CM			
输出电压	14.5±0.5V 25安培			
一箱只数	50			
铝壳尺寸				
重要说明				
产品编号	R2011.6.1		 <p>1. Battery (+) / Bateria (+) 2. Power Coil / Bobina de Carga 3. GND / Masa 4. Power Coil / Bobina de Carga 5. Power Coil / Bobina de Carga 6. Power Coil / Bobina de Carga</p>	Yamaha Outboard 1998 50h 4 str Regulator Rectifier 62Y-81960-00-00 (A16-2F)
产品单重	150克			
检测程序	315			
电线插头	15CM			
内盒尺寸	12*9.5*6CM			
外箱尺寸	49.5*25.5*30.5CM			
输出电压	14.5±0.5V			
一箱只数	50			
铝壳尺寸				
重要说明				
产品编号	R2011.6.2		 <p>1. Battery (+) / Bateria (+) 2. GND / Masa 4. Power Coil / Bobina de Carga 5. Power Coil / Bobina de Carga 6. Power Coil / Bobina de Carga</p>	64j-81960-10-00 64j-81960-00-00 2004 Yamaha 50 60 h
产品单重	150克			
检测程序	315			
电线插头	25CM			
内盒尺寸	12*9.5*6CM			
外箱尺寸	49.5*25.5*30.5CM			
输出电压	14.5±0.5V			
一箱只数	50			
铝壳尺寸				
重要说明				

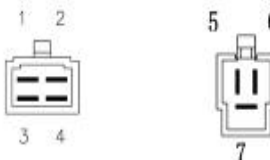

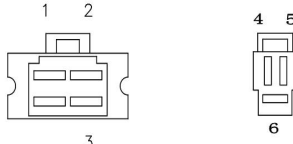

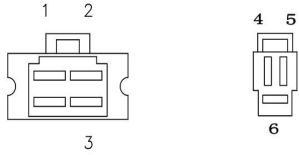

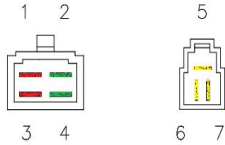
产品资料1		实物主图	接口图	适用范围
产品编号	R2011.7		 <p>1. GND 2. Battery (+) 3. Power Coil 4. Power Coil 5. Power Coil</p>	ves a LXV 125 ie 2010 Regulator/Rectifier 2013 VES A LX 150 LX150 VOLTAGE REGULATOR RECTIFIER OEM USED (Fits: Ves a)
产品单重	150克			
检测程序	M325			
电线插头	15 25CM			
内盒尺寸	12*9.5*6CM			
外箱尺寸	49.5*25.5*30.5CM			
输出电压	14.5±0.5V			
一箱只数	50			
铝壳尺寸				
重要说明				
产品编号	R2011.8		 <p>1. GND 绿线 2. Power Coil 白线 大灯 3. Power Coil 黄线 4. Battery (+) 红线</p>	Yamaha YFZ 450 2012 2013 1 D-81960-00-00 Yamaha YFZ 450 2004 2009 5TG-81960-00-00
产品单重	150克			
检测程序	半波HS08 2406 CA+CC			
电线插头	20 CM 小线			
内盒尺寸	12*9.5*6CM			
外箱尺寸	49.5*25.5*30.5CM			
输出电压	14.5±0.5V 12安培			
一箱只数	50			
铝壳尺寸				
重要说明				
产品编号	R2011.9		 <p>1. Battery (+) / Bateria (+) 2. Power Coil / Bobina de Carga 3. Power Coil / Bobina de Carga 4. Power Coil / Bobina de Carga 5. GND / Masa</p>	Suzuki GN125E 1991—1996 Suzuki GN250 1982—1988
产品单重	150克			
检测程序	315			
电线插头	20 35CM			
内盒尺寸	12*9.5*6CM			
外箱尺寸	49.5*25.5*30.5CM			
输出电压	14.5±0.5V			
一箱只数	50			
铝壳尺寸				
重要说明				
产品编号	R2011.10		 <p>1. Battery (+) / Bateria (+) 2. Ignition Switch / Sensor 3. GND / Masa 4. Power Coil / Bobina de Carga 5. Charge Lamp/ Lámpara Piloto 6. Power Coil / Bobina de Carga</p>	OEM: M97348 AM70121 AM126304 / 21066-2056 / 21066-2070 JJOHN DEERE 130 15A M70121 JOHN DEERE 160 15A M70121 JOHN DEERE 165 15A M70121 JOHN DEERE 170 15A M70121 JOHN DEERE 172 15A M70121 JOHN DEERE 175 15A M70121 JOHN DEERE 176 15A M70121 JOHN DEERE 180 15A M70121 JOHN DEERE 185 15A M70121
产品单重	150克			
检测程序	QF2101 新 2317 2316			
电线插头	15CM			
内盒尺寸	12*9.5*6CM			
外箱尺寸	49.5*25.5*30.5CM			
输出电压	14.5±0.5V 20安培			
一箱只数	50			
铝壳尺寸				
重要说明				

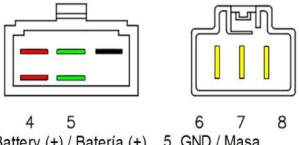
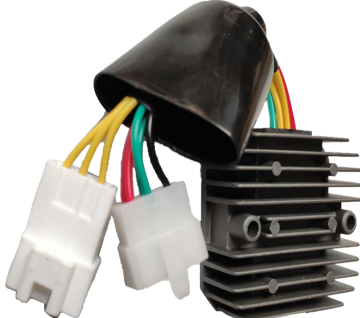
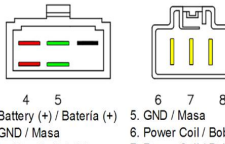

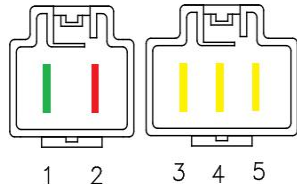

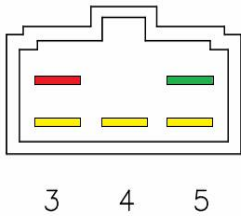

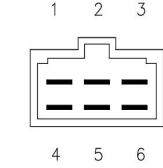
产品资料1		实物主图	接口图	适用范围
产品编号	R2011.11		 <p>1. Battery (+) / Bateria (+) 2. GND / Masa 3. Power Coil / Bobina de Carga 4. Power Coil / Bobina de Carga 5. Power Coil / Bobina de Carga</p>	2573 Yamaha YFM Warrior 350 2002 2004 4KB-81960-10 Yamaha YFM Wolverine 350 2002 2005 4KB-81960-10
产品单重	150克			
检测程序	325 2573			
电线插头	10CM			
内盒尺寸	12*9.5*6CM			
外箱尺寸	49.5*25.5*30.5CM			
输出电压	14.5±0.5V 35安培			
一箱只数	50			
铝壳尺寸				
重要说明				
产品编号	R2011.12		 <p>1. Power Coil / Bobina de Carga (Yellow/ Amarillo) 2. Power Coil / Bobina de Carga (Yellow/ Amarillo) 3. Power Coil / Bobina de Carga (Yellow/ Amarillo) 4. Battery (+) / Bateria (+) 5. GND/ Masa</p>	32800-89L00 Suzuki DF9.9B/15A/20A (elektrische starter) Suzuki DF9.9B 2013-2017 Suzuki DF15A 2013-2017 Suzuki DF20A 2013-2017
产品单重	150克			
检测程序	315			
电线插头	15CM			
内盒尺寸	12*9.5*6CM			
外箱尺寸	49.5*25.5*30.5CM			
输出电压	14.5±0.5V			
一箱只数	50			
铝壳尺寸				
重要说明				
产品编号	R2011.13		 <p>1. Battery (+) / Bateria (+) (Red/ Rojo) 2. Power Coil / Bobina de Carga (Green-White/ Verde-Blanco) 3. Power Coil / Bobina de Carga (Green/Verde) 4. GND / Masa</p>	SH76314 6ah-81960-00-00 6H0-81960-00 Yamaha 4 Stroke 15H 20H F15 F20 Outboard Engine
产品单重	150克			
检测程序	215			
电线插头	10 20 50CM			
内盒尺寸	12*9.5*6CM			
外箱尺寸	49.5*25.5*30.5CM			
输出电压	14.5±0.5V			
一箱只数	50			
铝壳尺寸				
重要说明				
产品编号	R2011.14		 <p>1. Battery (+) / Bateria (+) 2. Power Coil / Bobina de Carga 3. GND / Masa 4. Power Coil / Bobina de Carga 5. Power Coil / Bobina de Carga 6. Power Coil / Bobina de Carga</p>	Yamaha Assembly 64J-81960-10-00 Outboard
产品单重	210克			
检测机码	315			
电线插头	15CM			
内盒尺寸	12*9.5*6CM			
外箱尺寸	49.5*25.5*30.5CM			
输出电压	14.5±0.5V			
一箱只数	50			
铝壳尺寸				
重要说明				

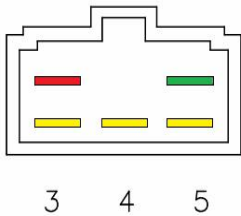

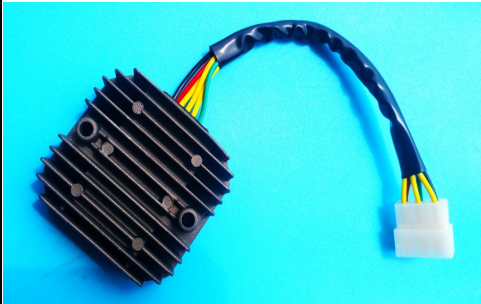
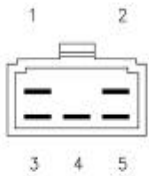

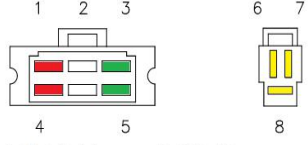

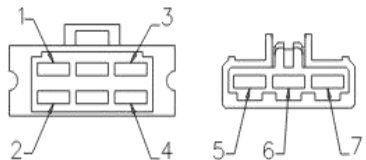
产品资料1		实物主图	接口图	适用范围
产品编号	R2011.15			SH696-12 HONDA 2001-LATER 8H - 9.9H 31750-ZW9-013 Outboard
产品单重	210克			
检测机码	215			
电线插头	40 60CM			
内盒尺寸	12*9.5*6CM			
外箱尺寸	49.5*25.5*30.5CM			
输出电压	14.5±0.5V			
一箱只数	50			
铝壳尺寸				
重要说明				
产品编号	R2011.16			KYMCO DOWNTOWN 250 300 AEON 3D 350 Elite
产品单重				
检测机码	M325			
电线插头	40 60CM			
内盒尺寸	12*9.5*6CM			
外箱尺寸	49.5*25.5*30.5CM			
输出电压	14.5±0.5V			
一箱只数	50			
铝壳尺寸				
重要说明				
产品编号	R2012.0		 <p>1. Battery (+) / Bateria (+) 2. Ignition Switch/ Sensor 3. GND / Masa</p> <p>4. Power Coil / Bobina de Carga 5. Power Coil / Bobina de Carga 6. Power Coil / Bobina de Carga</p>	Honda ES R 150 2008 2010 31600-KTF-641 Honda ES R 150 2008 2010 31600-KTF-641 Honda ES 125 2006 2010 31600-KTF-641 Honda ES 150 2006 2010 31600-KTF-641 Honda S 125 2010 2012 31600-KTF-641 Honda SH 150 2005 2012 31600-KTF-641 Honda SH 125 2005 2012 31600-KTF-641 Reem lazo Shin ngen SH541PA
产品单重	300克			
检测程序	325			
电线插头	20CM			
内盒尺寸	12*9.5*6CM			
外箱尺寸	49.5*25.5*30.5CM			
输出电压	14.5±0.5V 35安培			
一箱只数	50			
铝壳尺寸				
重要说明				
产品编号	R2012.1		 <p>1. Battery (+) / Bateria (+) 2. GND / Masa 3. Battery (+) / Bateria (+) 4. GND / Masa</p> <p>5. Power Coil / Bobina de Carga 6. Power Coil / Bobina de Carga 7. Power Coil / Bobina de Carga</p>	2054 25A Honda XLV Transal 600 1989 1999 31600-MS6-921 Reem lazo ietcard 1092 Reem lazo Shin ngen SH538D-13
产品单重	300克			
检测程序	325 2054			
电线插头	25CM			
内盒尺寸	12*9.5*6CM			
外箱尺寸	49.5*25.5*30.5CM			
输出电压	14.5±0.5V 25安培			
一箱只数	50			
铝壳尺寸				
重要说明				

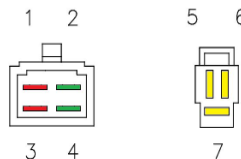

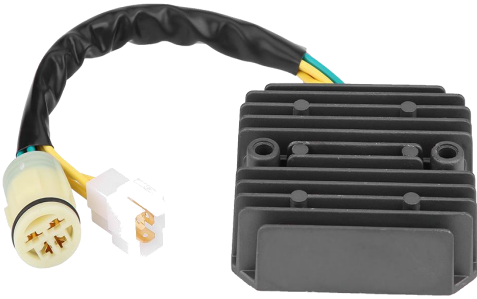
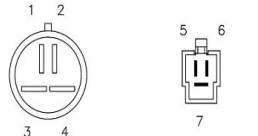

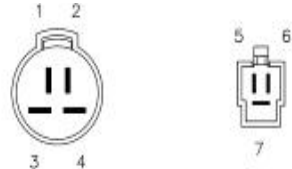
产品资料1		实物主图	接口图	适用范围
产品编号	R2012.1A		 <p>1. Battery (+) / Bateria (+) 2. Ignition Switch/ Sensor 3. GND / Masa 4. Battery (+) / Bateria (+) 5. GND / Masa 6. Power Coil / Bobina de Carga 7. Power Coil / Bobina de Carga 8. Power Coil / Bobina de Carga</p>	2087 25A Honda NX N 650 Reem lazo Shin ngen SH538A-12 2076 25A Honda XLV Transal 600 1987 1990 31600-MM9-000 Honda XRV Africa Twin 650 1988 1989 31600-MS8-000 Reem lazo ietcard 1187 Reem lazo ietcard 1186 Reem lazo Shin ngen SH538A SH538A-
产品单重	300克			
检测程序	325 2087 2076			
电线插头	25CM			
内盒尺寸	12*9.5*6CM			
外箱尺寸	49.5*25.5*30.5CM			
输出电压	14.5±0.5V 25安培			
一箱只数	50			
铝壳尺寸				
重要说明	黑线检测			
产品编号	R2012.1.1		 <p>1. Battery (+) / Bateria (+) 2. GND / Masa 3. Battery (+) / Bateria (+) 4. GND / Masa 5. Power Coil / Bobina de Carga 6. Power Coil / Bobina de Carga 7. Power Coil / Bobina de Carga</p>	2501 Honda NT Hawk GT 650 1988 1991 31600-MN8-028 Honda NT Hawk GT 650 1988 1991 31600-MN8-008 Honda NT Hawk GT 650 1988 1991 31600-MN8-018 Reem lazo Shin ngen SH538C-12
产品单重	300克			
检测程序	325 2501			
电线插头	25CM			
内盒尺寸	12*9.5*6CM			
外箱尺寸	49.5*25.5*30.5CM			
输出电压	14.5±0.5V 35安培			
一箱只数	50			
铝壳尺寸				
重要说明				
产品编号	R2012.1.1A		 <p>1. Battery (+) / Bateria (+) 2. GND / Masa 3. Battery (+) / Bateria (+) 4. GND / Masa 5. Power Coil / Bobina de Carga 6. Power Coil / Bobina de Carga 7. Power Coil / Bobina de Carga</p>	Honda 1989-90 CBR600 F Hurricane 31600-MN4-018 SH541-12 1987 Honda CBR600F RECTIFIER VOLTAGE REGULATOR OEM #31600-MN4-008 31600- MN4-018 Honda CBR 600 F # C19 # 1987 Honda CBR 600 F # C19 # 1988 Honda CBR 600 F # C23 # 1989 Honda CBR 600 F # C23 # 1990
产品单重	300克			
检测程序	325 2308			
电线插头	黄线25 红绿线20 CM			
内盒尺寸	12*9.5*6CM			
外箱尺寸	49.5*25.5*30.5CM			
输出电压	14.5±0.5V 35安培			
一箱只数	50			
铝壳尺寸				
重要说明				
产品编号	R2012.1.2		 <p>1. Ignition Switch / Sensor 2. Battery (+) / Bateria (+) 3. GND / Masa 4. Power Coil / Bobina de Carga 5. Power Coil / Bobina de Carga 6. Power Coil / Bobina de Carga</p>	2056 35A Honda CB SC Nighthawk 450 1982 1986 31600-MC9-740 Honda CB 400 1978 31600-413-008 Honda CB T Hawk 400 1980 1981 31600-413-008 Honda CB T Hawk 450 1982 31600-413- 008 Honda CB T 250 1978 1979 31600-KV8- 681 Honda CB S 250 1978 1985 31600-MC9-
产品单重	300克			
检测程序	325 2056			
电线插头	25CM 注意套管是3 个			
内盒尺寸	12*9.5*6CM			
外箱尺寸	49.5*25.5*30.5CM			
输出电压	14.5±0.5V 35安培			
一箱只数	50			
铝壳尺寸				
重要说明				

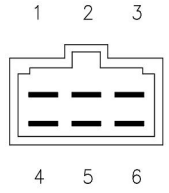

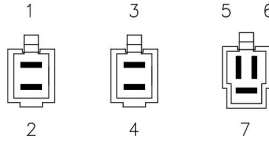

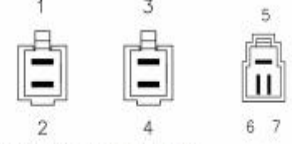
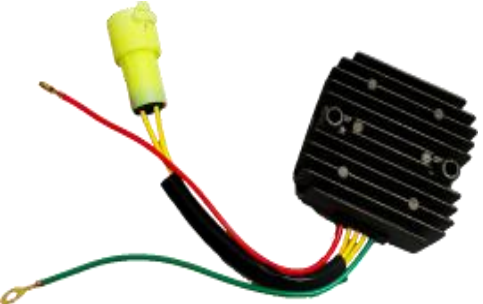
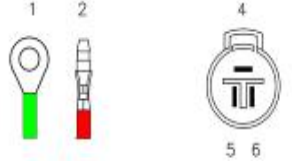

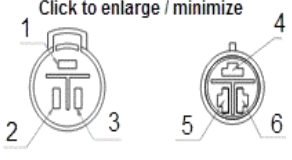
产品资料1		实物主图	接口图	适用范围
产品编号	R2012B. 1. 2		 <p>1. Ignition Switch / Sensor 2. Battery (+) / Bateria (+) 3. GND / Masa 4. Power Coil / Bobina de Carga 5. Power Coil / Bobina de Carga 6. Power Coil / Bobina de Carga</p>	2056 35A Honda CB SC Nighthawk 450 1982 1986 31600-MC9-740 Honda CB 400 1978 31600-413-008 Honda CB T Hawk 400 1980 1981 31600-413-008 Honda CB T Hawk 450 1982 31600-413-008 Honda CB T 250 1978 1979 31600-KV8-681 Honda CB S 250 1978 1985 31600-MC9-
产品单重	300克			
检测程序	M25 2056			
电线插头	25CM			
内盒尺寸	12*9.5*6CM			
外箱尺寸	49.5*25.5*30.5CM			
输出电压	14.5±0.5V 35安培			
一箱只数	50			
铝壳尺寸				
重要说明				
产品编号	R2012. 1. 3		 <p>1. Battery (+) / Bateria (+) 2. GND / Masa 3. Battery (+) / Bateria (+) 4. GND / Masa 5. Power Coil / Bobina de Carga 6. Power Coil / Bobina de Carga 7. Power Coil / Bobina de Carga</p>	2308 35A Honda CB Super Four 1300 1998 2002 31600-MBR-000 Honda CBR F 600 1987 1988 31600-MN4-008 Honda CBR F 600 1987 1990 31600-MN4-018 Honda CBR R 400 1986 1987 31600-KT8-013 Honda NTV Revere 650 1988 1997 31600-MS9-003
产品单重	300克			
检测程序	325 2308			
电线插头	35 CM			
内盒尺寸	12*9.5*6CM			
外箱尺寸	49.5*25.5*30.5CM			
输出电压	14.5±0.5V 35安培			
一箱只数	50			
铝壳尺寸				
重要说明				
产品编号	R2012. 2		 <p>1. Battery (+) / Bateria (+) 2. GND / Masa 3. Ignition Switch / Sensor 4. Battery (+) / Bateria (+) 5. GND / Masa 6. Power Coil / Bobina de Carga 7. Power Coil / Bobina de Carga 8. Power Coil / Bobina de Carga</p>	31600-MCF-003 Honda VTR 1000 S Y S 1 2000 SH678C-12
产品单重	300克			
检测程序	M325			
电线插头	35 CM			
内盒尺寸	12*9.5*6CM			
外箱尺寸	49.5*25.5*30.5CM			
输出电压	14.5±0.5V			
一箱只数	50			
铝壳尺寸				
重要说明	长线款			
产品编号	R2012. 2A		 <p>1. Battery (+) / Bateria (+) 2. GND / Masa 3. Ignition Switch / Sensor 4. Battery (+) / Bateria (+) 5. GND / Masa 6. Power Coil / Bobina de Carga 7. Power Coil / Bobina de Carga 8. Power Coil / Bobina de Carga</p>	Honda VTR 1000 SH541J 678-12 31600-MCF-003 31600-MCF-003
产品单重	300克			
检测程序	M325			
电线插头	25 CM			
内盒尺寸	12*9.5*6CM			
外箱尺寸	49.5*25.5*30.5CM			
输出电压	14.5±0.5V			
一箱只数	50			
铝壳尺寸				
重要说明	短线+胶套			

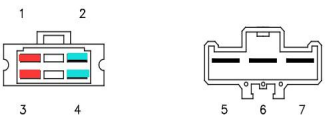
产品资料1		实物主图	接口图	适用范围
产品编号	R2012.3		 <p>1. GND 2. Battery (+) 3. Power Coil 4. Power Coil 5. Power Coil</p>	FH008EB Shin ngen 31600-MEL-013 31600-MEL-821 31600-MEL-A21 Honda CBR 1000 RR 2004至2007 CBR1000RR RM30019 2006 HONDA 998cc CBR1000RR RM30019 2007 HONDA 998cc CBR1000RR Re sol Edition RM30019 2006 HONDA 998cc CBR1000RR Re sol Edition RM30019 2007 HONDA 998cc
产品单重	300克			
检测程序	M325			
电线插头	25CM			
内盒尺寸	12*9.5*6CM			
外箱尺寸	49.5*25.5*30.5CM			
输出电压	14.5±0.5V			
一箱只数	50			
铝壳尺寸				
重要说明				
产品编号	R2012.4		 <p>1. Battery (+) 2. GND 3. Power Coil 4. Power Coil 5. Power Coil</p>	2496 Kawasaki VN Vulcan 800 1995 2005 21066-1099 Kawasaki VN Classic 800 1996 2005 21066-1099 Kawasaki VN Drifter 800 2000 2006 21066-1099 Kawasaki ZX 6R Ninja 600 1998 1999 21066-1099 Reem lazo Shin ngen SH650-12
产品单重	300克			
检测程序	325 2496			
电线插头	25CM			
内盒尺寸	12*9.5*6CM			
外箱尺寸	49.5*25.5*30.5CM			
输出电压	14.5±0.5V 35安培			
一箱只数	50			
铝壳尺寸				
重要说明				
产品编号	R2012.4.1		 <p>1. Battery (+) / Bateria (+) 2. Ignition Switch / Sensor 3. GND / Masa 4. Power Coil / Bobina de Carga 5. Charge Lamp/ Lámpara Piloto 6. Power Coil / Bobina de Carga</p>	2498 Kawasaki EJ W 650 1999 2005 21066-1106 Kawasaki VN Vulcan Classic 1500 1996 2008 21066-1106 Kawasaki VN Vulcan Nomad 1500 1999 2001 21066-1106 Kawasaki VN Vulcan Nomad FI 1500 2000 2004 21066-1106 Kawasaki VN Vulcan Nomad 1600 2005 2008 21066-1106
产品单重	300克			
检测程序	325 2498			
电线插头	40CM			
内盒尺寸	12*9.5*6CM			
外箱尺寸	49.5*25.5*30.5CM			
输出电压	14.5±0.5V 35安培			
一箱只数	50			
铝壳尺寸				
重要说明	长线款			
产品编号	R2012.4.2		 <p>1. Battery (+) 2. GND 3. Power Coil 4. Power Coil 5. Power Coil</p>	2506 Arctic Cat - 2X4 / 4X4 500 1998 1999 3430-016 Arctic Cat - 2X4 / 4X4 400 1997 1999 3430-072 Arctic Cat Bearcat 2X4 / 4X4 454 1997 1998 3430-037 Suzuki LT-F W / X mo ls 500 1998 2002 32800-44D11 2486 Yamaha FZS Fazer 600 2002 2003 5RT-
产品单重	300克			
检测程序	325 2463 2486 2506			
电线插头	50CM			
内盒尺寸	12*9.5*6CM			
外箱尺寸	49.5*25.5*30.5CM			
输出电压	14.5±0.5V 35安培			
一箱只数	50			
铝壳尺寸				
重要说明				

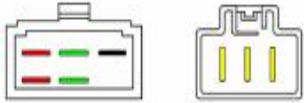

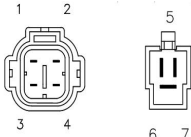

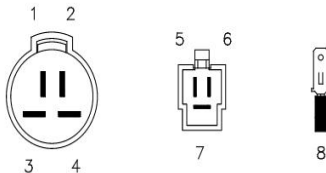

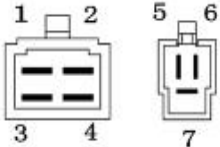
产品资料1		实物主图	接口图	适用范围
产品编号	R2012. 5. 1		 <ol style="list-style-type: none"> 1. Battery (+) / Bateria (+) 2. GND / Masa 3. Power Coil / Bobina de Carga 4. Power Coil / Bobina de Carga 5. Power Coil / Bobina de Carga 	2487 Yamaha FZS Fazer 600 1998 1999 3LS-81960-01 Yamaha TDM 850 1993 1996 3VD-81960-01 Yamaha XV Virago 250 1995 3LS-81960-00 Yamaha XVZ 1300 1996 1997 3LS-81960-00 Yamaha XVZ 1300 1997 2001 3VD-81960-01
产品单重	300克			
检测程序	325 2487			
电线插头	25CM			
内盒尺寸	12*9.5*6CM			
外箱尺寸	49.5*25.5*30.5CM			
输出电压	14.5±0.5V 35安培			
一箱只数	50			
铝壳尺寸				
重要说明				
产品编号	R2012. 6		 <ol style="list-style-type: none"> 1. Battery (+) / Bateria (+) 2. Ignition Switch / Sensor 3. GND / Masa 4. Battery (+) / Bateria (+) 5. GND / Masa 6. Power Coil / Bobina de Carga 7. Power Coil / Bobina de Carga 8. Power Coil / Bobina de Carga 	2499 35A Reem lazo Shin ngen SH541-12 Suzuki GV GLF Madura 700 1985 32800-05A00 Suzuki GV Madura 1200 1985 1986 32800-05A00 2079 25A Honda CH Freeway 250 1993 1994 31600-KAB-901 Honda CH Elite 250 1989 1990 31600-KE8-010
产品单重	300克			
检测程序	325 2499 2079			
电线插头	25CM			
内盒尺寸	12*9.5*6CM			
外箱尺寸	49.5*25.5*30.5CM			
输出电压	14.5±0.5V 35安培			
一箱只数	50			
铝壳尺寸				
重要说明				
产品编号	R2012. 7		 <ol style="list-style-type: none"> 1. Battery (+) / Bateria (+) 2. Battery (+) / Bateria (+) 3. Battery (-) / Bateria (-) 4. Power Coil / Generator 5. Power Coil / Generator 6. Power Coil / Generator 7. Power Coil / Generator 	2460 12V 35A Aprilia RSV R Tuono 1000 2002 2005 A 8124267 Aprilia RSV S /R 1000 1998 2003 A 8124267 Aprilia SL Falco 1000 2000 2002 A 8124267
产品单重	300克			
检测程序	M325 2460			
电线插头	黄1.5 X 20CM			
内盒尺寸	12*9.5*6CM			
外箱尺寸	49.5*25.5*30.5CM			
输出电压	14.5±0.5V 35安培			
一箱只数	50			
铝壳尺寸				
重要说明				
产品编号	R2012. 8		 <ol style="list-style-type: none"> 1. Battery (+) / Bateria (+) 2. GND / Masa 3. Battery (+) / Bateria (+) 4. GND / Masa 5. Power Coil / Bobina de Carga 6. Power Coil / Bobina de Carga 7. Power Coil / Bobina de Carga 	2061 25A Honda VT Shadow 600 31600-MY0-771 Honda VT C 600 1988 31600-MR1-000 Honda VT C 600 1988 1991 31600-MR1-003 Honda VT C 600 1988 1989 31600-MR1-010 Honda VT C / CD 600 1988 2007 31600-MY0-771 Honda VT Nighthawk GT 650 31600-MY0-771
产品单重	300克			
检测程序	315 2061			
电线插头	25CM			
内盒尺寸	12*9.5*6CM			
外箱尺寸	49.5*25.5*30.5CM			
输出电压	14.5±0.5V 25			
一箱只数	50			
铝壳尺寸				
重要说明				



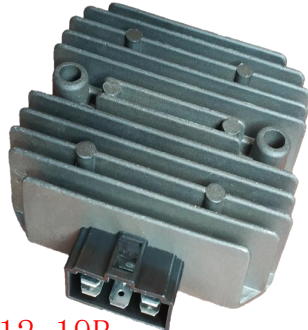
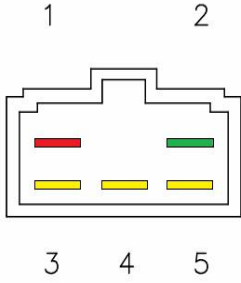

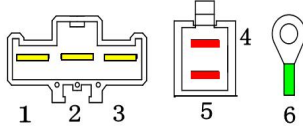
产品资料1		实物主图	接口图	适用范围
产品编号	R2012.9		 <p>1. Battery (+) / Bateria (+) 2. Battery (+) / Bateria (+) 3. GND / Masa 4. GND / Masa 5. Power Coil / Bobina de Carga 6. Power Coil / Bobina de Carga 7. Power Coil / Bobina de Carga</p>	2361 Honda XRV Africa Twin 750 1993 2003 31600-MY1-003 New Regulator Rectifier for Honda XRV750 XR 750 Africa Twin 1993-2000 SH538D-13
产品单重	300克			
检测程序	325 2361			
电线插头	25CM			
内盒尺寸	12*9.5*6CM			
外箱尺寸	49.5*25.5*30.5CM			
输出电压	14.5±0.5V 35安培			
一箱只数	50			
铝壳尺寸				
重要说明				
产品编号	R2012.9A		 <p>1. Battery (+) / Bateria (+) 2. Battery (+) / Bateria (+) 3. GND / Masa 4. GND / Masa 5. Power Coil / Bobina de Carga 6. Power Coil / Bobina de Carga 7. Power Coil / Bobina de Carga</p>	2387 Honda XRV Africa Twin 750 from 1993 to 2000 31600-MY1-003
产品单重	300克			
检测程序	325 2387			
电线插头	25CM			
内盒尺寸	12*9.5*6CM			
外箱尺寸	49.5*25.5*30.5CM			
输出电压	14.5±0.5V 35安培			
一箱只数	50			
铝壳尺寸				
重要说明				
产品编号	R2012.10		 <p>1. Battery (+) / Bateria (+) 2. Ignition Switch / Sensor 3. GND / Masa 4. Power Coil / Bobina de Carga 5. Power Coil / Bobina de Carga 6. Power Coil / Bobina de Carga</p>	Kawasaki VN Vulcan 800 de 1995 a 2005 21066-1099 Kawasaki VN Classic 800 de 1996 a 2005 21066-1099 Kawasaki VN Drifter 800 de 2000 a 2006 21066-1099 Kawasaki ZX 6R Ninja 600 de 1998 a 1999 21066-1099 Reemplazo Shindengen SH650-12 Kawasaki EJ W 650 de 1999 a 2005 21066-1106
产品单重	300克			
检测程序	325 2496 2498			
电线插头	45CM			
内盒尺寸	12*9.5*6CM			
外箱尺寸	49.5*25.5*30.5CM			
输出电压	14.5±0.5V 35安培			
一箱只数	50			
铝壳尺寸				
重要说明	3黑线交流1黑红正1黑白负1墨绿检测			
产品编号	R2012.10.1		 <p>1. Battery (+) / Bateria (+) (Red/Rojo) 2. Battery (+) / Bateria (+) (Red/Rojo) 3. GND / Masa (Green/Verde) 4. GND / Masa (Green/Verde) 5. Power Coil / Bobina de Carga 6. Power Coil / Bobina de Carga 7. Power Coil / Bobina de Carga</p>	2477 Honda VT C Shadow 1100 2001 2003 31600-MCK-A01 Honda VT C Shadow 1100 1995 1997 31600-MAH-008 Honda VT C Shadow 1100 1997 1998 31600-MAA-A01 Honda VT C2 Shadow 1100 1997 1999 31600-MAA-A01 Honda VT C Shadow 1100 1987 1994 31600-MM8-008
产品单重	300克			
检测程序	325 2477			
电线插头	40CM			
内盒尺寸	12*9.5*6CM			
外箱尺寸	49.5*25.5*30.5CM			
输出电压	14.5±0.5V 35安培			
一箱只数	50			
铝壳尺寸				
重要说明	3黄线2红2绿 3插带钩			

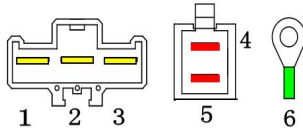

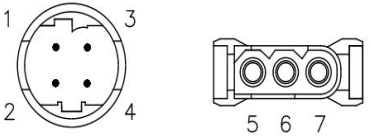

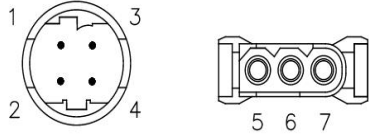

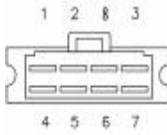
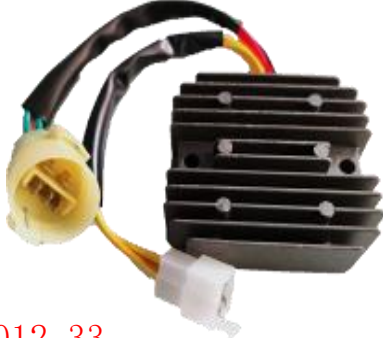
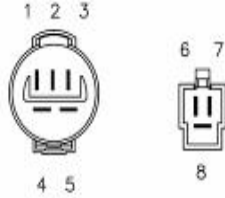
产品资料1		实物主图	接口图	适用范围
产品编号	R2012. 10. 2		 <p>1. Battery (+) / Bateria (+) (Red/Rojo) 2. Battery (+) / Bateria (+) (Red/Rojo) 3. GND / Masa (Green/Verde) 4. GND / Masa (Green/Verde) 5. Power Coil / Bobina de Carga 6. Power Coil / Bobina de Carga 7. Power Coil / Bobina de Carga</p>	HONDA VT 1100 VT 1100 C2 SHADOW 1995-1999 MOTORCYCLE HONDA VT1100 VT 1100 C SHADOW S IRIT 1998-2005 MOTORCYCLE HONDA VT1100 VT 1100 T ACE TOURER 1998-2001 MOTORCYCLE HONDA VT1100 VT 1100 C SHADOW 1987-1997 MOTORCYCLE HONDA VT1100 VT 1100 C2-2 ACE 1997-1998 MOTORCYCLE HONDA VT1100 VT 1100 C3 AERO 1998-2002 MOTORCYCLE
产品单重	300克			
检测程序	325			
电线插头	40CM			
内盒尺寸	12*9.5*6CM			
外箱尺寸	49.5*25.5*30.5CM			
输出电压	14.5±0.5V			
一箱只数	50			
铝壳尺寸				
重要说明	3黄线2红2绿 3插 不带钩			
产品编号	R2012. 11		 <p>1. GND / Masa 2. Battery (+) / Bateria (+) 4. Power Coil / Bobina de Carga 5. Power Coil / Bobina de Carga 6. Power Coil / Bobina de Carga</p>	Mercury 75-90 H 4 Stroke 804278A12 804278T11 水星 75H 90H
产品单重	300克			
检测程序	315			
电线插头	25CM			
内盒尺寸	12*9.5*6CM			
外箱尺寸	49.5*25.5*30.5CM			
输出电压	14.5±0.5V			
一箱只数	50			
铝壳尺寸				
重要说明				
产品编号	R2012. 12		 <p>Click to enlarge / minimize</p> <p>1.Yellow / Amarillo : Power Coil / Generator 2.Yellow / Amarillo : Power Coil / Generator 3.Yellow / Amarillo : Power Coil / Generator 4.Green / Verde : Battery (-) / Bateria (-) 5.Black / Negro : Sensor / Sensor 6.Red / Rojo : Battery (+) / Bateria (+)</p>	2456 HondaATCES / SX250 1985 198731600-HA0-000 HondaTRX250 1985 198731600-HA8-770
产品单重	300克			
检测程序	325 2456			
电线插头	50 70 CM			
内盒尺寸	12*9.5*6CM			
外箱尺寸	49.5*25.5*30.5CM			
输出电压	14.5±0.5V 25安培			
一箱只数	50			
铝壳尺寸				
重要说明				
产品编号	R2012. 13		 <p>1. Battery (+) / Bateria (+) 2. GND/ Masa 3. Battery (+) / Bateria (+) 4. GND/ Masa 5. Power Coil / Bobina de Carga 6. Power Coil / Bobina de Carga 7. Power Coil / Bobina de Carga</p>	2581 ApriliaETVCa o Nord ABS1000 2004 2007A 8124831 ApriliaETVCa o Nord Rally1000 2001 2003A 8124831 ApriliaRSTFutura1000 2001 2004A 8124831
产品单重	300克			
检测程序	M325 2581			
电线插头	25CM			
内盒尺寸	12*9.5*6CM			
外箱尺寸	49.5*25.5*30.5CM			
输出电压	14.5±0.5V MOSFET 35安培			
一箱只数	50			
铝壳尺寸				
重要说明				

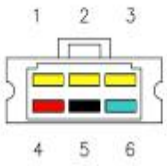

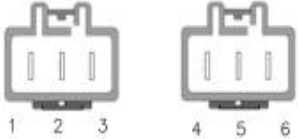

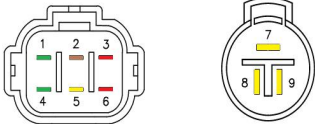

产品资料1		实物主图	接口图	适用范围
产品编号	R2012.14		 4 5 6 7 8 1. Battery (+) / Batería (+) 5. GND / Masa 2. GND / Masa 6. Power Coil / Bobina de Carga 3. Ignition Switch / Sensor 7. Power Coil / Bobina de Carga 4. Battery (+) / Batería (+) 8. Power Coil / Bobina de Carga	Honda CBR954RR
产品单重	300克			
检测程序	325			
电线插头	35CM			
内盒尺寸	12*9.5*6CM			
外箱尺寸	49.5*25.5*30.5CM			
输出电压	14.5±0.5V			
一箱只数	50	R2012.14	R2012.14	
铝壳尺寸			 1 2 5 3 4 6 7 1. Battery (+) / Batería (+) 5. Power Coil / Bobina de Carga 2. Battery (+) / Batería (+) 6. Power Coil / Bobina de Carga 3. GND / Masa 7. Power Coil / Bobina de Carga 4. GND / Masa	Arctic Cat - 3530-028 Arctic Cat ATV AUTO 4x4 400 2003 3402-682 Arctic Cat ATV AUTO 4x4 400 2004 2005 3402-682 Arctic Cat ATV TBX AUTO 4x4 400 2006 3402-682 Arctic Cat ATV V AUTO 4x4 400 2005 2006 3402-682 Arctic Cat ATV FIS AUTO 2x4 / 4x4 400 2003 2008 3402-682
重要说明				
产品编号	R2012.15			
产品单重	300克			
检测程序	325 2455			
电线插头	25CM			
内盒尺寸	12*9.5*6CM			
外箱尺寸	49.5*25.5*30.5CM			
输出电压	14.5±0.5V 35安培	R2012.15	R2012.15	
一箱只数	50		 1 2 5 6 8 3 4 7 1. Battery (+) / Batería (+) 5. Power Coil / Bobina de Carga 2. Battery (+) / Batería (+) 6. Power Coil / Bobina de Carga 3. GND / Masa 7. Power Coil / Bobina de Carga 4. GND / Masa 8. Ignition Switch / Sensor	2356 Honda XRV Africa Twin 650 hasta 1990
重要说明	3黄线2红线2绿线1黑线检测			
产品编号	R2012.16			
产品单重	240克			
检测程序	325 2356			
电线插头	25CM			
内盒尺寸	12*9.5*6CM			
外箱尺寸	49.5*25.5*30.5CM			
输出电压	14.5±0.5V 35安培	R2012.16	R2012.16	
一箱只数	50		 1 2 5 6 3 4 7 1. Battery (+) 2. GND (-) 3. Ignition 4. Charge lamp 5. Power Coil 6. Power Coil 7. Power Coil	Yamaha XV Virago 700 1984 1985 4X7-81960-A0-00 Yamaha XV Virago 750 1981 1983 4X7-81960-A0-00 Yamaha XV Virago Shaftdrive 920 1981 1983 4X7-81960-A0-00 Yamaha XV SE 1000 1983 1985 4X7-81960-A0-00 Yamaha XZ Vision 550 1982 1984 4X7-81960-A0-00 Yamaha YX Radian 600 1989 1990 3LT-
重要说明	3白线交流1红正1黑负1棕检测1白指示			
产品编号	R2012.17			
产品单重	300克			
检测程序	325 参考 2333			
电线插头	3白线AC25 红黑黄棕35CM			
内盒尺寸	12*9.5*6CM			
外箱尺寸	49.5*25.5*30.5CM			
输出电压	14.5±0.5V 35安培	R2012.17	R2012.17	
一箱只数	50			
铝壳尺寸				
重要说明				

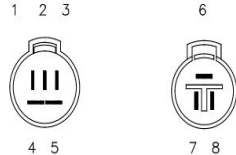

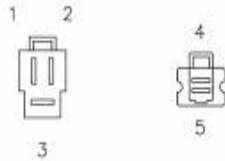

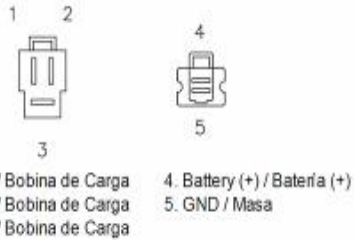

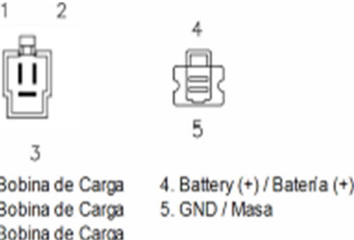
产品资料1		实物主图	接口图	适用范围						
产品编号	R2012.17A		 <p>1. Battery (+) / Bateria (+) 5. Power Coil / Bobina de Carga 2. GND / Masa 6. Power Coil / Bobina de Carga 3. Charge Lamp / Lampara Piloto 7. Power Coil / Bobina de Carga</p>	Yamaha XV Virago 700 de 1984 a 1985 4X7-81960-A0-00 Yamaha XV Virago 750 de 1981 a 1983 4X7-81960-A0-00 Yamaha XV Virago Shaftdrive 920 de 1981 a 1983 4X7-81960-A0-00 Yamaha XV SE 1000 de 1983 a 1985 4X7- 81960-A0-00 Yamaha XZ Vision 550 de 1982 a 1984 4X7-81960-A0-00 Yamaha YX Radian 600 de 1989 a 1990						
产品单重	300克			R2012.17A	R2012.17A	2332 35A Yamaha XVZ Venture 1200 1983 1985 26H-81960-A0 Yamaha XVZ Venture Royale 1300 1988 1989 26H-81960-A0 Yamaha XVZ Venture Royale 1300 1986 1993 2WR-81960-A0				
检测程序	325 参考 2333				 <p>1. Battery (+) / Bateria (+) 5. Power Coil / Bobina de Carga 2. GND / Masa 6. Power Coil / Bobina de Carga 3. Battery (+) / Bateria (+) 7. Power Coil / Bobina de Carga 4. GND / Masa</p>					
电线插头	黄线25 红绿35CM					R2012.18	R2012.18	2064 25A Kawasaki EX Ninja R 250 2008 2012 21066-0027 Kawasaki KLR 650 2008 2018 21066- 0027 Kawasaki KLX 250 2018 2019 21066- 0027 Kawasaki KLX S 250 2009 2014 21066- 0027 Kawasaki VN Vulcan 1500 1996 1999 21066-1089		
内盒尺寸	12*9.5*6CM						 <p>1. Battery (+) / Bateria (+) 2. Ignition Switch / Sensor 3. GND / Masa 4. Power Coil / Bobina de Carga 5. Power Coil / Bobina de Carga 6. Power Coil / Bobina de Carga</p>			
外箱尺寸	49.5*25.5*30.5CM							R2012.19	R2012.19	2376 Arctic Cat - H1 650 2005 2006 0824- 037 Arctic Cat - H1 550 2009 2011 0824- 037 Arctic Cat - H1 700 2009 2011 0824- 037 Arctic Cat FIS H1 650 2007 2008 0824-037 Arctic Cat FIS 700 2006 2008 0824- 037
输出电压	14.5±0.5V 35安培									
一箱只数	50									
铝壳尺寸										
重要说明	3白线交流1红正1黑负 1白指示灯									
产品编号	R2012.18									
产品单重	320克									
检测程序	325 2332									
电线插头	35CM									
内盒尺寸	12*9.5*6CM									
外箱尺寸	49.5*25.5*30.5CM									
输出电压	14.5±0.5V 35安培									
一箱只数	50									
铝壳尺寸										
重要说明	3白线交流2红正2黑负									
产品编号	R2012.19									
产品单重	260克									
检测程序	325 2443 2078 2064 2078									
电线插头	6针插头									
内盒尺寸	12*9.5*6CM									
外箱尺寸	49.5*25.5*30.5CM									
输出电压	14.5±0.5V 25安培									
一箱只数	50									
铝壳尺寸										
重要说明	6针插头									
产品编号	R2012.19A									
产品单重	260克									
检测程序	325 2364 2375 2376									
电线插头	6插只用5针									
内盒尺寸	12*9.5*6CM									
外箱尺寸	49.5*25.5*30.5CM									
输出电压	14.5±0.5V 35安培									
一箱只数	50									
铝壳尺寸										
重要说明										
		R2012.19A	R2012.19A							

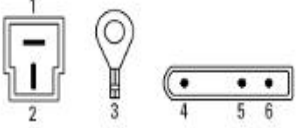

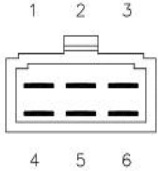

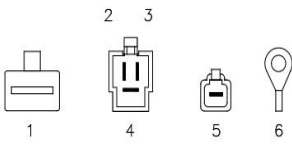
产品资料1		实物主图	接口图	适用范围
产品编号	R2012.19B		 <ol style="list-style-type: none"> 1. Battery (+) 2. GND 3. Power Coil 4. Power Coil 5. Power Coil 	2504 35A Reem lazo Shin ngen SH719AA Yamaha FZ6 Fazer 600 2004 2009 5VX-81960-00-00 2349 35A Benelli Velvet 250 1999 2003 R51540071A0 MBK Skyliner 250 2000 2001 4JH-81960-01 eugeot Elyseo 125 737918 eugeot Elyseo 150 737918
产品单重	260克			
检测程序	325 2504 2349			
电线插头	5针插头			
内盒尺寸	12*9.5*6CM			
外箱尺寸	49.5*25.5*30.5CM			
输出电压	14.5±0.5V 35安培			
一箱只数	50			
铝壳尺寸				
重要说明	5针插头			
产品编号	R2012.20		 <ol style="list-style-type: none"> 1. Power Coil / Bobina de Carga 2. Power Coil / Bobina de Carga 3. Power Coil / Bobina de Carga 4. Battery (+) / Bateria (+) 5. Battery (+) / Bateria (+) 6. GND/ Masa 	2561 KTM Adventure 990 2006 2007 60011034000 KTM Adventure 950 2003 2006 60011034000 KTM Adventure 990 2008 2012 60011034100 KTM Duke Orange / White 690 2008 60011034000 KTM Duke 690 2009 2018 60011034100 KTM Duke R 690 2010 2016
产品单重	300克			
检测程序	M325 2561 2504			
电线插头	25 CM			
内盒尺寸	12*9.5*6CM			
外箱尺寸	49.5*25.5*30.5CM			
输出电压	14.5±0.5V 35安培			
一箱只数	50			
铝壳尺寸				
重要说明	另一种做法是25+黄线65CM			
产品编号	R2012.20A		 <ol style="list-style-type: none"> 1. Power Coil / Bobina de Carga 2. Power Coil / Bobina de Carga 3. Power Coil / Bobina de Carga 4. Battery (+) / Bateria (+) 5. Battery (+) / Bateria (+) 6. GND/ Masa 	2561 KTM Adventure 990 2006 2007 60011034000 KTM Adventure 950 2003 2006 60011034000 KTM Adventure 990 2008 2012 60011034100 KTM Duke Orange / White 690 2008 60011034000 KTM Duke 690 2009 2018 60011034100 KTM Duke R 690 2010 2016
产品单重	300克			
检测程序	M325 2561 2504			
电线插头	25 CM			
内盒尺寸	12*9.5*6CM			
外箱尺寸	49.5*25.5*30.5CM			
输出电压	14.5±0.5V 35安培			
一箱只数	50			
铝壳尺寸				
重要说明	3插 是公插			
产品编号	R2012.21		 <ol style="list-style-type: none"> 1. GND / Masa 2. GND / Masa 3. Battery (+) / Bateria (+) 4. Battery (+) / Bateria (+) 5. Power Coil / Bobina de Carga 6. Power Coil / Bobina de Carga 7. Power Coil / Bobina de Carga 	2585 BMW F GS Dakar 650 de 2000 a 2007 61312346550 BMW F GS 700 de 2011 a 2016 61312346550 BMW F S 800 de 2005 a 2008 61312346550 BMW F ST 800 de 2005 a 2013 61312346550 BMW F CS 650 de 2001 a 2005 61312346550
产品单重	300克			
检测程序	M325 2585 2586			
电线插头	35CM			
内盒尺寸	12*9.5*6CM			
外箱尺寸	49.5*25.5*30.5CM			
输出电压	14.5±0.5V MOSFET 35安培			
一箱只数	50			
铝壳尺寸				
重要说明	长线款			



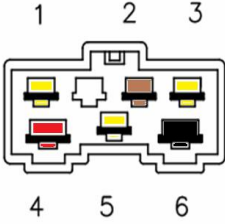

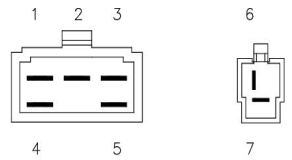
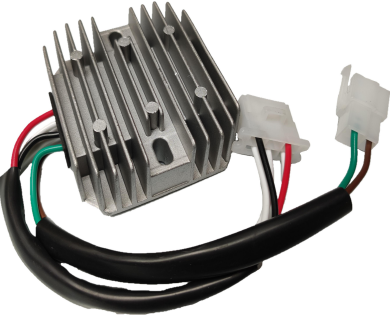
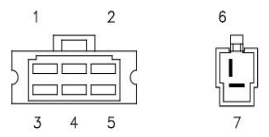

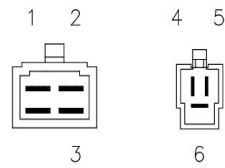
产品资料1		实物主图	接口图	适用范围
产品编号	R2012.21A		 <p>1. GND / Masa 2. GND / Masa 3. Battery (+) / Bateria (+) 4. Battery (+) / Bateria (+) 5. Power Coil / Bobina de Carga 6. Power Coil / Bobina de Carga 7. Power Coil / Bobina de Carga</p>	2586 BMW C GT 400 de 2018 a 2019 61317707943 BMW C X 400 de 2018 a 2019 61317707943 BMW F R 800 de 2016 a 2018 61317707943 BMW F GT 800 de 2016 a 2018 61317707943 BMW F GS 800 de 2015 a 2018 61317707943
产品单重	300克			
检测程序	M325 2585 2586			
电线插头	25CM			
内盒尺寸	12*9.5*6CM			
外箱尺寸	49.5*25.5*30.5CM			
输出电压	14.5±0.5V MOSFET 35安培			
一箱只数	50			
铝壳尺寸				
重要说明	短线款 以后此款 会停产			
产品编号	R2012.22		 <p>1. Battery (+) / Bateria (+) 2. Power Coil / Bobina de Carga 3. GND / Masa 4. Battery (+) / Bateria (+) 5. Power Coil / Bobina de Carga 6. Power Coil / Bobina de Carga 7. GND / Masa 8. Ignition Switch/ Sensor</p>	2307 25A Honda CB HondaMatic 750 1977 1978 31700-371-000 Honda GL Goldwing 1100 1980 1983 31600-MG9-010 Honda GL Goldwing 1100 1980 1983 31600-463-008 Honda GL Goldwing DG 1200 1984 1987 31600-MG9-000 Honda GL Goldwing DG 1200 1984 1987 31600-MG9-010
产品单重	320克			
检测程序	325 2307			
电线插头	25CM			
内盒尺寸	12*9.5*6CM			
外箱尺寸	49.5*25.5*30.5CM			
输出电压	14.5±0.5V 25安培			
一箱只数	50			
铝壳尺寸				
重要说明	3黄2红2绿1黑检测			
产品编号	R2012.33		 <p>1. Ignition Switch/ Sensor 2. Battery (+) / Bateria (+) 3. Battery (+) / Bateria (+) 4. GND / Masa 5. GND / Masa 6. Power Coil / Bobina de Carga 7. Power Coil / Bobina de Carga 8. Power Coil / Bobina de Carga</p>	2360 Honda XRV Africa Twin 750 1990 1991 31600-MV1-003 Reem lazo ietcard 1431 HONDA XRV 750 AFRICA TWIN '90/91 RIF. SH538A-11
产品单重	净重300克盒重325克			
检测程序	325 2360			
电线插头	25CM			
内盒尺寸	12*9.5*6CM			
外箱尺寸	49.5*25.5*30.5CM			
输出电压	14.5±0.5V 35安培			
一箱只数	50			
铝壳尺寸	安装孔是平整的			
重要说明	3黄2红2绿1黑检测			
产品编号	R2012.35		 <p>1. Power Coil / Bobina de Carga 2. Power Coil / Bobina de Carga 3. Power Coil / Bobina de Carga 4. Battery (+) / Bateria (+) 5. Ignition Switch / Sensor 6. GND / Masa</p>	YHC068 Honda FES125 (ANTHEON) 2003-2005 Honda FES150 (ANTHEON) 2003-2005
产品单重	300克			
检测程序	315			
电线插头	25CM			
内盒尺寸	12*9.5*6CM			
外箱尺寸	49.5*25.5*30.5CM			
输出电压	14.5±0.5V			
一箱只数	50			
铝壳尺寸				
重要说明				

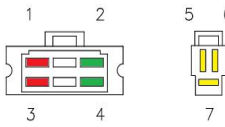

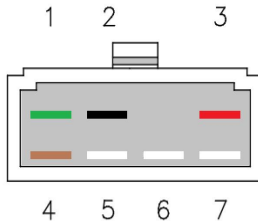

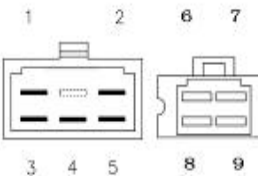

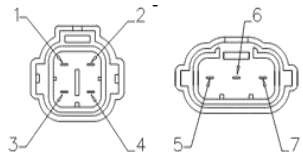
产品资料1		实物主图	接口图	适用范围
产品编号	R2012.36		 <p>1. Power Coil / Bobina de Carga 2. Power Coil / Bobina de Carga 3. Power Coil / Bobina de Carga 4. Battery (+) / Bateria (+) 5. Ignition Switch / Sensor 6. GND / Masa</p>	Honda FES150 (S-WING)2007-2012 Honda FES125 (S-WING)2007-2009
产品单重	300克			
检测程序	325			
电线插头	35CM			
内盒尺寸	12*9.5*6CM			
外箱尺寸	49.5*25.5*30.5CM			
输出电压	14.5±0.5V			
一箱只数	50			
铝壳尺寸				
重要说明				
产品编号	R2012.37		 <p>1. GND / Masa 2. Ignition Switch/ Sensor 3. Battery (+) / Bateria (+) 4. GND / Masa 5. AC Signal Out / Salida Señal CA 6. Battery (+) / Bateria (+) 7. Power Coil / Bobina de Carga 8. Power Coil / Bobina de Carga 9. Power Coil / Bobina de Carga</p>	Arctic Cat V-2 4X4 FIS 650 2004 2005 0430-035 Arctic Cat V-Twin Automatic 4X4 FIS 650 2006 0430-046 0430-035
产品单重	370克			
检测程序	325 2542			
电线插头	15 100CM			
内盒尺寸	12*9.5*6CM			
外箱尺寸	49.5*25.5*30.5CM			
输出电压	14.5±0.5V 35安培			
一箱只数	50			
铝壳尺寸				
重要说明				
产品编号	R2012.38		 <p>1. Battery (+) / Bateria (+) 2. Ignition Switch/ Sensor 3. GND / Masa 4. 5. AC Output / Salida AC 6. Power Coil / Bobina de Carga 7. Power Coil / Bobina de Carga 8. Power Coil / Bobina de Carga</p>	2398 接口待客户确认 KawasakiKLFBayou300 2002 200521066-1112 KawasakiKSVKFX700700 2004 200921066-1112 KawasakiKVF rairie650 2002 2003 21066-1112 KawasakiKVF rairie300 1999 2002 21066-1112 KawasakiKVF rairie700 2004 2006 21066-1112
产品单重	300克			
检测程序	325 2398			
电线插头	25CM			
内盒尺寸	12*9.5*6CM			
外箱尺寸	12*9.5*6CM			
输出电压	14.5±0.5V 35安培			
一箱只数	50			
铝壳尺寸				
重要说明				
产品编号	R2012.38A		 <p>1. Battery (+) / Bateria (+) 2. Ignition Switch/ Sensor 3. GND / Masa 4. Battery (+) / Bateria (+) 5. GND / Masa 6. Power Coil / Bobina de Carga 7. Power Coil / Bobina de Carga 8. Power Coil / Bobina de Carga</p>	2398 KawasakiKLFBayou300 2002 200521066-1112 KawasakiKSVKFX700700 2004 200921066-1112 KawasakiKVF rairie650 2002 2003 21066-1112 KawasakiKVF rairie300 1999 2002 21066-1112 KawasakiKVF rairie700 2004 2006 21066-1112
产品单重				
检测程序	325 2398			
电线插头	20CM			
内盒尺寸	12*9.5*6CM			
外箱尺寸	49.5*25.5*30.5CM			
输出电压	14.5±0.5V 35安培			
一箱只数	50			
铝壳尺寸				
重要说明				



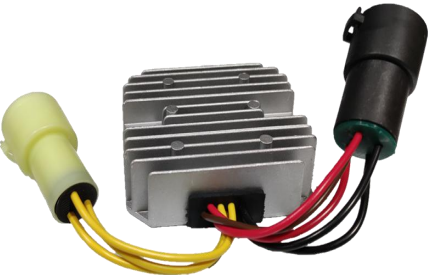
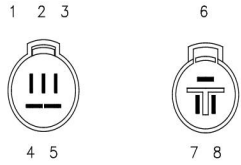

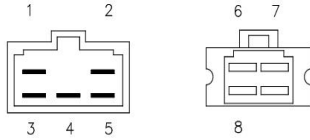

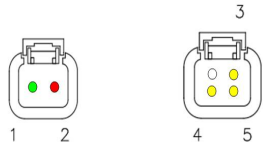
产品资料1		实物主图	接口图	适用范围
产品编号	R2012.40			
产品单重				
检测程序	325			
电线插头	25CM			
内盒尺寸	12*9.5*6CM			
外箱尺寸	49.5*25.5*30.5CM			
输出电压	14.5±0.5V			
一箱只数	50			
铝壳尺寸				
重要说明				
产品编号	R2012.44		 <p>1. Power Coil / Bobina de Carga 2. Power Coil / Bobina de Carga 3. Power Coil / Bobina de Carga 4. Battery (+) / Bateria (+) 5. GND / Masa</p>	Honda VT750 Shadow VT750DC 01-07 31600-MCR-A01 也适用于 31600-SAB-0000-M1 DAELIM SV125 SABA-0901
产品单重	克			
检测程序	325			
电线插头	45CM			
内盒尺寸	12*9.5*6CM			
外箱尺寸	49.5*25.5*30.5CM			
输出电压	14.5±0.5V			
一箱只数	50			
铝壳尺寸				
重要说明	安装孔是平整的			
产品编号	R2012.44A		 <p>1. Power Coil / Bobina de Carga 2. Power Coil / Bobina de Carga 3. Power Coil / Bobina de Carga 4. Battery (+) / Bateria (+) 5. GND / Masa</p>	Daelim 125 VL Daystar FI 2007-2012
产品单重	克			
检测程序	325			
电线插头	45CM			
内盒尺寸	12*9.5*6CM			
外箱尺寸	49.5*25.5*30.5CM			
输出电压	14.5±0.5V			
一箱只数	50			
铝壳尺寸				
重要说明	安装孔是平整的			
产品编号	R2012.45		 <p>1 sensor / ignition switch 2 bateria (+) / battery (+) 3 masa / GND 4-5-6 bobina de carga / power coil</p>	2432 Aprilia Leonardo ST 250 300 1999 2005 A 8112941 Aprilia MOTO 650 1995 1999 A 8112941 Aprilia egaso 3 / IE 6501996 2004 A 8112941 BMW F Funduro 650 1993 2000 61 31 2 346 432 BMW F ST 650 1997 2000 61 31 2 346 432
产品单重	克			
检测程序	325 2432			
电线插头	25CM 1.5平方			
内盒尺寸	12*9.5*6CM			
外箱尺寸	49.5*25.5*30.5CM			
输出电压	14.5±0.5V 35安培			
一箱只数	50			
铝壳尺寸	安装孔是平整的			
重要说明	3黄线1红1棕负极 1 绿是检测线			
产品编号	R2012.45			

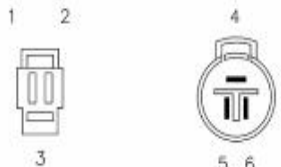

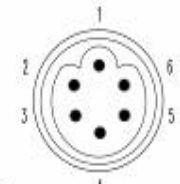

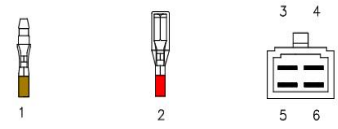
产品资料1		实物主图	接口图	适用范围
产品编号	R2012.47		 <p>1. Battery (+) / Bateria (+) 2. Ignition Switch / Sensor 3. GND / Masa 4. Power Coil / Bobina de Carga 5. Power Coil / Bobina de Carga 6. Power Coil / Bobina de Carga</p>	2080 25A Gilera - Dakota 350 328041 Gilera - Saturno 500 328041 Gilera - XRT 350 328041 Gilera - Nord West 600 328041 Gilera - RC / R / Cobra 600 328041 Reem lazo Shin ngen SH238 Yamaha XTZ Su er Tenere 750 1992 1994 5A8-81960-A0 Yamaha XTZ Tenere 660 1992 1993 5A8-81960-A0
产品单重	300克			
检测程序	315 2087			
电线插头	25CM			
内盒尺寸	12*9.5*6CM			
外箱尺寸	49.5*25.5*30.5CM			
输出电压	14.5±0.5V 25			
一箱只数	50			
铝壳尺寸	安装孔是平整的			
重要说明	3白线1红1 绿1 黑检测			
产品编号	R2012B.23		 <p>1. Battery (+) / Bateria (+) 2. Power Coil / Bobina de Carga 3. Power Coil / Bobina de Carga 4. Power Coil / Bobina de Carga 5. Power Coil / Bobina de Carga 6. Power Coil / Bobina de Carga 7. GND / Masa</p>	2464 Bajaj Rouser NS 200 JL402002
产品单重	240克			
检测程序	325 2464			
电线插头	12 20 30 32CM			
内盒尺寸	12*9.5*6CM			
外箱尺寸	49.5*25.5*30.5CM			
输出电压	14.5±0.5V 35安培			
一箱只数	50			
铝壳尺寸				
重要说明				
产品编号	R2012B.24		 <p>1. GND / Masa 2. Battery (+) / Bateria (+) 3. Power Coil / Bobina de Carga 4. Power Coil / Bobina de Carga 5. Power Coil / Bobina de Carga 6. Power Coil / Bobina de Carga</p>	2382 Honda NX Falcon 400 hasta 2014 31600-MCG-850 Reem lazo Shin ngen SH532GF
产品单重	280克净重			
检测程序	325 2482			
电线插头	25CM			
内盒尺寸	12*9.5*6CM			
外箱尺寸	49.5*25.5*30.5CM			
输出电压	14.5±0.5V 35安培			
一箱只数	50			
铝壳尺寸				
重要说明				
产品编号	R2012B.25		 <p>1. Power Coil 2. Ignition Switch 3. Power Coil 4. Battery (+) 5. Power Coil 6. GND</p>	Kawasaki KLF 4x4 400 de 1993 a 1999 21066-1078 Kawasaki KLF Bayou 400 de 1996 a 1999 21066-1078 Kawasaki KVF raire 400 de 1997 a 1998 21066-1078 Reem lazo Shindengen SH541E-12
产品单重	300克			
检测程序	M325 2624			
电线插头	黄红绿1.5 X 15CM			
内盒尺寸	12*9.5*6CM			
外箱尺寸	49.5*25.5*30.5CM			
输出电压	14.5±0.5V 35安培			
一箱只数	50			
铝壳尺寸				
重要说明				

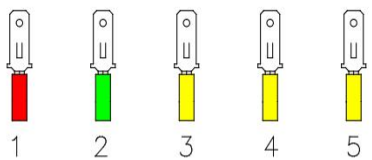
产品资料1		实物主图	接口图	适用范围
产品编号	R2012B. 26		 <p>1. Battery (+) / Bateria (+) 2. Power Coil / Bobina de Carga 3. Power Coil / Bobina de Carga 4. GND / Masa</p> <p>5. Power Coil / Bobina de Carga 6. Field Coil / Bobina de Campo 7. Ignition Switch / Sensor</p>	2331 25A Yamaha TX 650 1974 447-81970-10 & 1L9-81910-50 Yamaha TX 650 1973 256-81970-11 & 1L9-81910-50 Yamaha XS 400 1977 1978 1L9-81970-60 & 1L9-81910-50 Yamaha XS XS-1 650 1970 256-81970-11 & 1L9-81910-50 Yamaha XS XS-1B 650 1971 256-81970-11 & 1L9-81910-50
产品单重	300克			
检测程序	CB750+励磁 2331			
电线插头	25CM			
内盒尺寸	12*9.5*6CM			
外箱尺寸	49.5*25.5*30.5CM			
输出电压	14.5±0.5V 25			
一箱只数	50			
铝壳尺寸				
重要说明	3白线1红1黑负 1棕检测1绿线励磁			
产品编号	R2012B. 26A		 <p>1. Battery (+) / Bateria (+) 2. GND / Masa 3. Power Coil / Bobina de Carga 4. Power Coil / Bobina de Carga</p> <p>5. Power Coil / Bobina de Carga 6. Field Coil / Bobina de Campo 7. Ignition Switch / Sensor</p>	2412 Yamaha XS 1100 1978 1981 1T4-81960-A0-00 Yamaha XS 850 1980 1981 1T4-81960-A0-00 Yamaha XS 750 1978 1T4-81960-92-00 Yamaha XS 850 1980 1T4-81960-92-00 Yamaha XS 750 1977 1979 1T4-81960-A0-00 Yamaha XS 1100 1979 1980 1T4-81960-92-00
产品单重	300克 净重 325元总重			
检测程序	CB750+励磁 2412			
电线插头	25CM			
内盒尺寸	12*9.5*6CM			
外箱尺寸	49.5*25.5*30.5CM			
输出电压	14.5±0.5V 25安培			
一箱只数	50			
铝壳尺寸				
重要说明	3白线1红1黑负 1棕检测1绿线励磁			
产品编号	R2012B. 27		 <p>1. Battery (+) / Bateria (+) 2. GND / Masa 3. Charge Lamp / Lampara Piloto</p> <p>4. Power Coil / Bobina de Carga 5. Power Coil / Bobina de Carga 6. Power Coil / Bobina de Carga 7. Power Coil / Bobina de Carga</p>	2333 35A Yamaha XV Virago 700 1984 1985 4X7-81960-A0-00 Yamaha XV Virago 750 1981 1983 4X7-81960-A0-00 Yamaha XV Virago Shaftdrive 920 1981 1983 4X7-81960-A0-00 Yamaha XV SE 1000 1983 1985 4X7-81960-A0-00 Yamaha XZ Vision 550 1982 1984 4X7-81960-A0-00
产品单重	300克			
检测程序	CB750+励磁 2333			
电线插头	白线15 红黑35CM			
内盒尺寸	12*9.5*6CM			
外箱尺寸	49.5*25.5*30.5CM			
输出电压	14.5±0.5V 35安培			
一箱只数	50			
铝壳尺寸				
重要说明	3白线交流1红1黑负 1黄线交流大灯			
产品编号	R2012B. 28		 <p>1. Battery (+) / Bateria (+) 2. GND / Masa 3. Battery (+) / Bateria (+) 4. GND / Masa</p> <p>5. Power Coil / Bobina de Carga 6. Power Coil / Bobina de Carga 7. Power Coil / Bobina de Carga</p>	2310 35A Honda CX Custom 650 1983 31600-MA1-008 Honda CX Euros ort 650 1983 31600-MA1-008 Honda GL Silverwing 650 1983 31600-MA1-008 Honda GL Silverwing 500 1981 1982 31600-MA1-008 Honda NV C 650 1983 31600-MG8-008 Honda VF S V45 Sabre 700 1984 1985
产品单重	300克			
检测程序	325 2310			
电线插头	25CM			
内盒尺寸	12*9.5*6CM			
外箱尺寸	49.5*25.5*30.5CM			
输出电压	14.5±0.5V 35安培			
一箱只数	50			
铝壳尺寸				
重要说明				

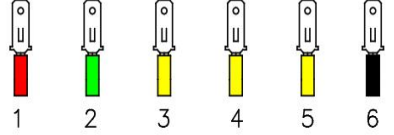

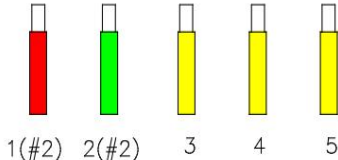

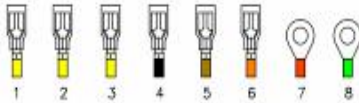

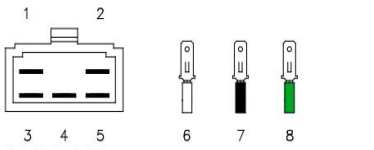
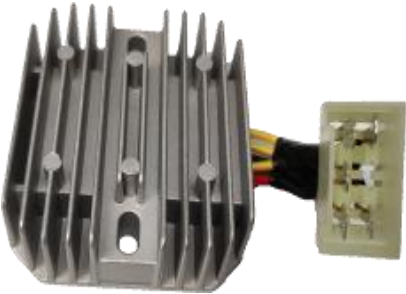
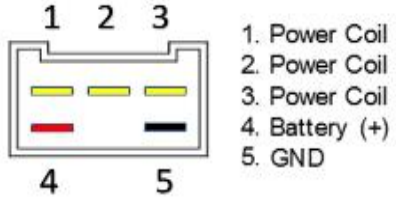
产品资料1		实物主图	接口图	适用范围
产品编号	R2012B. 29		 <ul style="list-style-type: none"> 1. Field Coil 2. GND 3. Battery (+) 4. Ignition Switch 5. Power Coil 6. Power Coil 7. Power Coil 	2481 25A CAM 0 - Reem lazo Shin ngen SH233-A12 Yamaha FJ 600 1984 1985 12R-81960-A1-00 Yamaha FZ 600 1986 1988 2XL-81960-A0-00 Yamaha XJ R Seca 650 1982 1983 4H7-81960-50 Yamaha XJ 600 1984 1986 12R-81960-A0-00 Yamaha XJ R Seca 900 1983 1984 12R-
产品单重	223克			
检测程序	325 2481			
电线插头	25CM			
内盒尺寸	12*9.5*6CM			
外箱尺寸	49.5*25.5*30.5CM			
输出电压	14.5±0.5V			
一箱只数	50			
铝壳尺寸				
重要说明				
产品编号	R2012B. 30		 <ul style="list-style-type: none"> 1. Field Coil 2. Ignition Switch 3. Power Coil 4. Power Coil 5. Power Coil 6. Battery (+) 7. GND (-) 8. Battery (-) 9. GND (-) 	Yamaha XJ 1100 Maxim 1982
产品单重	300克			
检测程序	CB750+励磁			
电线插头	20CM			
内盒尺寸	12*9.5*6CM			
外箱尺寸	49.5*25.5*30.5CM			
输出电压	14.5±0.5V			
一箱只数	50			
铝壳尺寸				
重要说明	3白线交流2红正2黑负 1棕检测1绿励磁			
产品编号	R2012B. 31		 <ul style="list-style-type: none"> 1. Battery (+) / Bateria (+) 2. Battery (+) / Bateria (+) 3. Battery (-) / Bateria (-) 4. Battery (-) / Bateria (-) 5. Power Coil / Generado 6. Power Coil / Generado 7. Power Coil / Generado 	2541 PolarisOutlaw450 2008 2010 4012536 PolarisOutlaw500 2006 20074012536 PolarisOutlawS / IRS525 2007 2011 4012536 Polaris redator500 2003 2007 4010654
产品单重	290克			
检测程序	325 2454 2541			
电线插头	25CM			
内盒尺寸	12*9.5*6CM			
外箱尺寸	49.5*25.5*30.5CM			
输出电压	14.5±0.5V 35安培			
一箱只数	50			
铝壳尺寸				
重要说明				
产品编号	R2012B. 32		 <ul style="list-style-type: none"> 1. Battery (+) / Bateria (+) 2. GND / Masa 3. Power Coil / Bobina de Carga 4. Power Coil / Bobina de Carga 5. Power Coil / Bobina de Carga 	2112-0557 Fits Early Mo l 2001 2001 Arctic Cat 400 2x4 Fits Early Mo l 2001 2001 Arctic Cat 400 4X4 2000 Arctic Cat 400 2x4 2000 Arctic Cat 400 4X4 Fits Early Mo l 2001 2001 Arctic Cat 500 4X4 2000 Arctic Cat 500 4X4
产品单重	300克			
检测程序	325			
电线插头	25CM			
内盒尺寸	12*9.5*6CM			
外箱尺寸	49.5*25.5*30.5CM			
输出电压	14.5±0.5V			
一箱只数	50			
铝壳尺寸				
重要说明				





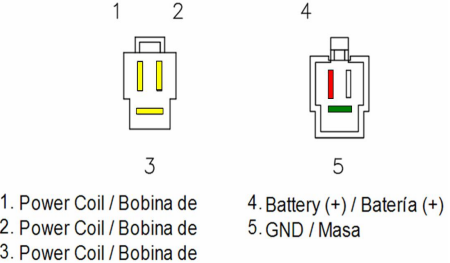

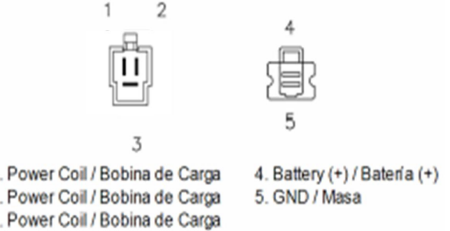
产品资料1		实物主图	接口图	适用范围
产品编号	R2012B. 38		 <p>1. Battery (+) / Bateria (+) 2. Ignition Switch/ Sensor 3. GND / Masa 4. Battery (+) / Bateria (+) 5. GND / Masa 6. Power Coil / Bobina de Carga 7. Power Coil / Bobina de Carga 8. Power Coil / Bobina de Carga</p>	AKI6034 SH541E-12 KAWASAKI KVF360 A1/A2/A3 rairie 360 4X4 2003-2005 KAWASAKI KVF360 C1 rairie 360 4X4 Advantage Classic 2003 KAWASAKI KVF360 B1/B2/B3/B6/B7/B8/B/B9 rairie 360 2003-2009 KAWASAKI KVF360 CAF/CBF rairie 360 4X4 Realtree A G HD 2010-2011 KAWASAKI KVF360
产品单重	300克			
检测程序	M325			
电线插头	15CM			
内盒尺寸	12*9.5*6CM			
外箱尺寸	49.5*25.5*30.5CM			
输出电压	14.5±0.5V 35安培			
一箱只数	50			
铝壳尺寸				
重要说明				
产品编号	R2012B. 39		 <p>1. GND / Masa 2. Battery (+) / Bateria (+) 3. GND / Masa 4. Ignition Switch/ Sensor 5. Battery (+) / Bateria (+) 6. Power Coil / Bobina de Carga 7. Power Coil / Bobina de Carga 8. Power Coil / Bobina de Carga</p>	Kawasaki ZN Voyager 1300 1987 1989 21066-1051 Reem lazo Shin ngen SH541-12D
产品单重				
检测程序	325 2531			
电线插头	15 CM			
内盒尺寸	12*9.5*6CM			
外箱尺寸	49.5*25.5*30.5CM			
输出电压	14.5±0.5V 35安培			
一箱只数	50			
铝壳尺寸				
重要说明				
产品编号	R2012B. 41		 <p>1. GND / Masa 2. Battery (+) / Bateria (+) 3. Power Coil / Bobina de Carga 4. Power Coil / Bobina de Carga 5. Power Coil / Bobina de Carga</p>	Ex edition V-800 S ort 2007 - 2008 Ski-Doo G GSX 500 SS S ort 2005 - 2007 Ski-Doo GSX 600 2005 Ski-Doo GSX 800 2005 Ski-Doo GSX 800 H.O. Limited 2006 Ski-Doo GSX 800 TEK 2007 Ski- Doo GTX 500 SS S ort 2005 - 2007 Ski-Doo GTX 600 2005 Ski-Doo GTX 800 2005 Ski-Doo GTX 800 H.O. Limited 2006 Ski-Doo Grand Touring 500 S ort 2003 Ski-Doo Grand Touring 600 SE 2003 Ski-Doo Grand Touring 600 S ort
产品单重				
检测程序	M325			
电线插头	20 CM			
内盒尺寸	12*9.5*6CM			
外箱尺寸	49.5*25.5*30.5CM			
输出电压	14.5±0.5V			
一箱只数	50			
铝壳尺寸				
重要说明	3黄线1红1黑负极			
产品编号	R2012. 42		 <p>1. Ignition Switch/ Sensor 2. Battery (+) / Bateria (+) 3. GND / Masa 4. Power Coil / Bobina de Carga 5. Power Coil / Bobina de Carga 6. Power Coil / Bobina de Carga</p>	Honda TRX Fourtrax 300 1988 1992 31600-HC4-010 / SH532B-12 Honda TRX Fourtrax FW 4x4 300 1988 31600-HC4-010 / SH532B-12 Honda TRX Fourtrax FW 4x4 300 1990 1992 31600-HC4-010 / SH532B-12
产品单重				
检测程序	315 2342			
电线插头	15 30CM			
内盒尺寸	12*9.5*6CM			
外箱尺寸	49.5*25.5*30.5CM			
输出电压	14.5±0.5V 25安培			
一箱只数	50			
铝壳尺寸				
重要说明	3黄线1红1绿1黑检测			

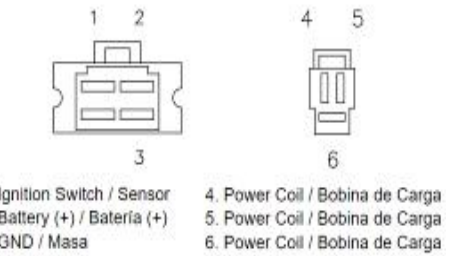

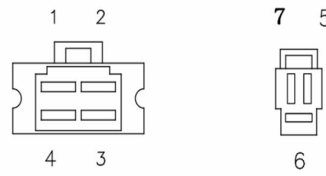
产品资料1		实物主图	接口图	适用范围
产品编号	R2012B. 46		 <p>1. GND / Masa 2. Ignition Switch / Sensor 3. Power Coil / Bobina de Carga 4. Power Coil / Bobina de Carga 5. Power Coil / Bobina de Carga 6. Battery (+) / Bateria (+)</p>	2340 Reem lazo Shin ngen SH235 Yamaha YFM Moto-4 225 1986 1988 59V-81960-A0-00 Yamaha YFM Moto-4 250 1989 1991 59V-81960-A0-00 Yamaha YFM FW 350 1987 1989 59V- 81960-A0-00 Yamaha YFM Big Bear F 350 1990 1994 59V-81960-A0-00 Yamaha YFM Warrior X 350 1987 1995
产品单重	净重270克盒重296克			
检测程序	315 2340			
电线插头	15CM			
内盒尺寸	12*9.5*6CM			
外箱尺寸	49.5*25.5*30.5CM			
输出电压	14.5±0.5V 25安培			
一箱只数	50			
铝壳尺寸				
重要说明	3白线1红1黑负 1棕检测			
产品编号	R2012B. 48		 <p>1. Ignition Switch/ Sensor 2. Battery (+) / Bateria (+) 3. GND / Masa 4. Power Coil / Bobina de Carga 5. Power Coil / Bobina de Carga 6. Power Coil / Bobina de Carga</p>	Yamaha YFB Timberwolf 250 1994 1996 4GB-81960-00-00 Yamaha YFB 250 1995 1996 4GB-81960- 00-00 Yamaha YFM Big Bear 350 1995 1996 4GB-81960-00-00 Yamaha YFM Moto-4 350 1995 4GB-81960- 00-00 Yamaha YFM Kodiak 400 1992 1995 4GB-81960-00-00
产品单重	300克			
检测程序	315 2339			
电线插头	15CM			
内盒尺寸	12*9.5*6CM			
外箱尺寸	49.5*25.5*30.5CM			
输出电压	14.5±0.5V 25安培			
一箱只数	50			
铝壳尺寸				
重要说明				
产品编号	R2012B. 49		 <p>1. Battery [+] / Bateria [+] (Red/Rojo) 2. GND / Masa (Green/Verde) 3. Power Coil / Bobina de Carga (Yellow/Amarillo) 4. Power Coil / Bobina de Carga (Yellow/Amarillo) 5. Power Coil / Bobina de Carga (Yellow/Amarillo)</p>	10183 Universal5 cables12V 35A s/s
产品单重	300克			
检测程序	325 10183			
电线插头	35CM			
内盒尺寸	12*9.5*6CM			
外箱尺寸	49.5*25.5*30.5CM			
输出电压	14.5±0.5V 35安培			
一箱只数	50			
铝壳尺寸				
重要说明				
产品编号	R2012B. 50		 <p>1. Battery [+] / Bateria [+] (Red/Rojo) 2. GND / Masa (Green/Verde) 3. Power Coil / Bobina de Carga (Yellow/Amarillo) 4. Power Coil / Bobina de Carga (Yellow/Amarillo) 5. Power Coil / Bobina de Carga (Yellow/Amarillo) 6. Ignition Switch/ Sensor (Black/Negro)</p>	10184 Universal6 cables12V 35A c/Sensor
产品单重	300克			
检测程序	325 10184 10186			
电线插头	35CM			
内盒尺寸	12*9.5*6CM			
外箱尺寸	49.5*25.5*30.5CM			
输出电压	14.5±0.5V 35安培			
一箱只数	50			
铝壳尺寸				
重要说明				

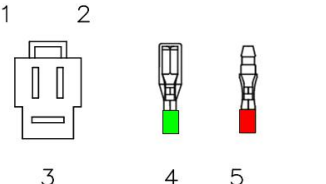

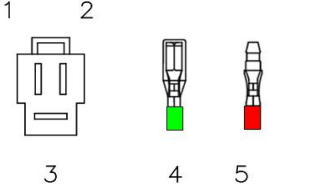

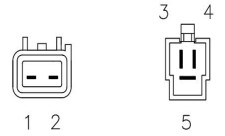

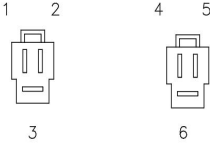
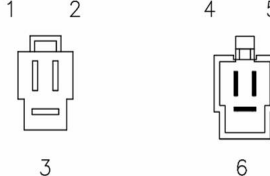
产品资料1		实物主图	接口图	适用范围
产品编号	R2012B. 51		 <p>1. Battery (+) / Bateria (+) (Red/Rojo) 2. GND / Masa (Green/ Verde) 3. Power Coil / Bobina de Carga (Yellow/Amarillo) 4. Power Coil / Bobina de Carga (Yellow/Amarillo) 5. Power Coil / Bobina de Carga (Yellow/Amarillo)</p>	10189 Universal7 cables12V 35A sin sensor
产品单重	300克			
检测程序	325 10189			
电线插头	25CM			
内盒尺寸	12*9.5*6CM			
外箱尺寸	49.5*25.5*30.5CM		 <p>1. Power Coil / Bobina de Carga (Yellow/ Amarillo) 2. Power Coil / Bobina de Carga (Yellow/ Amarillo) 3. Power Coil / Bobina de Carga (Yellow/ Amarillo) 4. Field Coil (-) / Bobina de Campo (-) (Black/ Negro) 5. Field Coil (+) / Bobina de Campo (+) (Brown/ Marrón) 6. Ignition Switch / Sensor (Orange/ Naranja) 7. Battery (+) / Bateria (+) (Red/ Rojo) 8. GND / Masa (Green/ Verde)</p>	2512 BMWR60/5600197312321244409 + 12311244063 BMW60/7600 1977 197812321244409 + 12311244063 BMW75/7750197712321244409 + 12311244063 BMW60/6600 1974 197612321244409 + 12311244063 BMW50/5500 1970 197312321244409 + 12311244063 BMW80RT800 1982 198712321244409 +
产品单重	300克			
检测程序	CB750 2512			
电线插头				
内盒尺寸	12*9.5*6CM			
外箱尺寸	49.5*25.5*30.5CM		 <p>1. Battery (+) / Bateria (+) 2. GND / Masa 3. Power Coil / Bobina de Carga 4. Power Coil / Bobina de Carga 5. Power Coil / Bobina de Carga 6. Field Coil / Bobina de Campo (White/ Blanco) 7. Ignition Switch / Sensor (Black/ Negro) 8. GND / Masa (Green/ Verde) CAMPO +</p>	10007 HondaCB750hasta 1976
产品单重	240克			
检测程序	CB750+励磁 10007			
电线插头	25CM			
内盒尺寸	12*9.5*6CM			
外箱尺寸	49.5*25.5*30.5CM		 <p>1. Power Coil 2. Power Coil 3. Power Coil 4. Battery (+) 5. GND</p>	Honda VFR 750 FA566023077 RC24 Bj. 1989
产品单重	240克			
检测程序	M325			
电线插头	15CM			
内盒尺寸	12*9.5*6CM			
外箱尺寸	49.5*25.5*30.5CM			
输出电压	14.5±0.5V 25安培			
一箱只数	50			
铝壳尺寸				
重要说明				

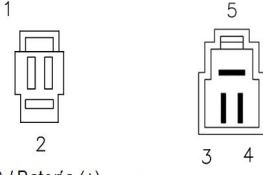

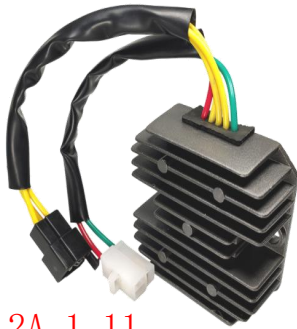

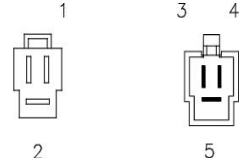

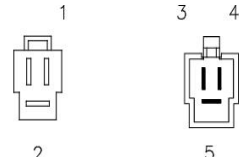
产品资料1		实物主图	接口图	适用范围
产品编号	R2012B.56			Honda VFR 750 F RC24 Bj. 1989 A566023077
产品单重	368克			
检测程序	M325 10007			
电线插头	25CM 黑线负极60CM			
内盒尺寸	12*9.5*6CM			
外箱尺寸	49.5*25.5*30.5CM			
电压电流	14.5±0.5V 50安培			
一箱只数	50			
铝壳尺寸				
重要说明	3黄2 红2 黑			
产品编号	R2012.57			2054 25A Honda VIZ400
产品单重	310克			
检测程序	325 2054			
电线插头	25CM			
内盒尺寸	12*9.5*6CM			
外箱尺寸	49.5*25.5*30.5CM			
输出电压	14.5±0.5V 25安培			
一箱只数	50			
铝壳尺寸				
重要说明				
产品编号	R2012A.0			2432 ApriliaLeonardoST250 1999 2005A 8112941 ApriliaLeonardoST300 1999 2005A 8112941 ApriliaMOTO650 1995 1999A 8112941 Aprilia egaso3 / IE650 1996 2004A 8112941 BMWFFunduro650 1993 200061 31 2 346 432 BMWFFST650 1997 200061 31 2 346 432 Reem lazoShin ngenSH532B-12r 2002-
产品单重	220克			
检测程序	325 2432			
电线插头	25CM			
内盒尺寸	12*9.5*6CM			
外箱尺寸	49.5*25.5*30.5CM			
输出电压	14.5±0.5V 35安培			
一箱只数	50			
铝壳尺寸				
重要说明				
产品编号	R2012A.1			Honda: GL1000 Goldwing 1975-1979 1978 1977 1976 Honda: VT1100, CH250, CBR250, G1100 1100 1200, VF750, VF1100S, Honda: STEED 400, VT700C, VT500C, TV600, VT1100C, XLV750R, TRX200SX Honda: NX650 NX 650 1988-1989 Honda: XV750 Virago XV920 XZ550 Vizion 1982-1983 Honda STEED400 VT600C VLX600
产品单重	207克			
检测程序	315			
电线插头	25CM			
内盒尺寸	12*9.5*6CM			
外箱尺寸	49.5*25.5*30.5CM			
输出电压	14.5±0.5V			
一箱只数	50			
铝壳尺寸				
重要说明				

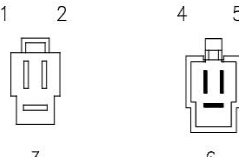

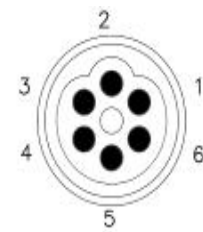

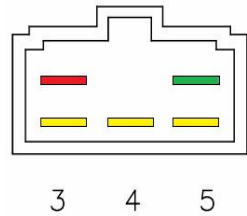

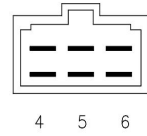
产品资料1		实物主图	接口图	适用范围
产品编号	R2012A.1D		 <p>1. Power Coil / Bobina de Carga 2. Power Coil / Bobina de Carga 3. Power Coil / Bobina de Carga 4. Battery (+) / Bateria (+) 5. GND / Masa</p>	DAE-31600-SAB-0000-M1 Daelim VJF VJ Roadwin Fi 125 VL Fi daystar 31600-SAB-0000-M1 31600-BA1-R300
产品单重	310克			
检测程序	325 2054			
电线插头	25CM			
内盒尺寸	12*9.5*6CM			
外箱尺寸	49.5*25.5*30.5CM			
输出电压	14.5±0.5V 25安培			
一箱只数	50			
铝壳尺寸				
重要说明				
产品编号	R2012A.1.1		 <p>1. Power Coil / Bobina de 2. Power Coil / Bobina de 3. Power Coil / Bobina de 4. Battery (+) / Bateria (+) 5. GND / Masa</p>	Honda CH125 Elite 125-149cc Honda CBT125 1982-1993 Honda CMX450 1986-1988
产品单重	220克			
检测程序	315			
电线插头	25CM			
内盒尺寸	12*9.5*6CM			
外箱尺寸	49.5*25.5*30.5CM			
输出电压	14.5±0.5V			
一箱只数	50			
铝壳尺寸				
重要说明	3黄1红1绿1黑检测			
产品编号	R2012A.1.2		 <p>1. Power Coil / Bobina de Carga 2. Power Coil / Bobina de Carga 3. Power Coil / Bobina de Carga 4. Battery (+) / Bateria (+) 5. GND / Masa</p>	2059 25A Honda XR L 650 1993 2009 31600-MY6-671 Honda XR L 650 2012 2017 31600-MY6-671 Reem lazo ietcard 1369 Reem lazo Shin ngen SH532C-13
产品单重	220克			
检测程序	315 2059			
电线插头	60CM			
内盒尺寸	12*9.5*6CM			
外箱尺寸	49.5*25.5*30.5CM			
输出电压	14.5±0.5V 25安培			
一箱只数	50			
铝壳尺寸				
重要说明	3插是带钩的			
产品编号	R2012A.1.3		 <p>1. Ignition Switch / Sensor 2. Battery (+) / Bateria (+) 3. GND / Masa 4. Power Coil / Bobina de Carga 5. Power Coil / Bobina de Carga 6. Power Coil / Bobina de Carga</p>	Betamotor Eikon 125 Betamotor Eikon 150 Daelim S2 250 31600-SZ1-900 Honda CH / AC 250 1985 1988 31600-KS4-841 Honda CH / AC 250 1985 1988 31600-KM1-008 Honda CH / AC 150 1985 1986 31600-KM1-008 Honda CH / AC 150 1985 1986 31600-KS4-841
产品单重	220克			
检测程序	325 2056			
电线插头	25CM			
内盒尺寸	12*9.5*6CM			
外箱尺寸	49.5*25.5*30.5CM			
输出电压	14.5±0.5V 35安培			
一箱只数	50			
铝壳尺寸				
重要说明				

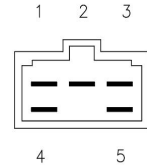
产品资料1		实物主图	接口图	适用范围
产品编号	R2012A. 1. 4		 <p>1. Ignition Switch / Sensor 2. Battery (+) / Bateria (+) 3. GND / Masa 4. Charge Lamp/三个二极管引出+</p> <p>5. Power Coil / Bobina de Carga 6. Power Coil / Bobina de Carga 7. Power Coil / Bobina de Carga</p>	31600-413-008;31600-LBA7-900; SH532B-12;SH 532-12;31600-M56-000 ; OE A 8112941;026001800;31600-KV8-681;31600-KS4-770; 00168780;026001800;32800-24;4X7-81960-A0-00 ;SH232-12 Honda CBR250 MC18 CAN-AM DS250;CAN-AM DS250CE ;BETA EIKON 125 OE=026001800 Honda Steed400 ,BMW F650GS F650ST Strada Funduro Dakar MOTO:
产品单重	220克			
检测程序	315			
电线插头	25CM			
内盒尺寸	12*9.5*6CM			
外箱尺寸	49.5*25.5*30.5CM			
输出电压	14.5±0.5V			
一箱只数	50			
铝壳尺寸				
重要说明	3黄线 1棕检测 1白线大灯 1红正1黑负			
产品编号	R2012A. 1. 5		 <p>1. Power Coil 2. Power Coil 3. Power Coil</p> <p>4. GND 5. Battery (+)</p>	Honda Rebel CMX250 CA250 SH561-12 大地鹰王DD250E/金太子CA250/嘉陵JH250 Honda CMX 250 C Rebel 2001 250 Honda CMX 250 C Rebel 2002 250 Honda CMX 250 C Rebel 2003 250 Honda CMX 250 C Rebel 2004 250 Honda CMX 250 C Rebel 2005 250 Honda CMX 250 C Rebel 2006 250 Honda CMX 250 C Rebel 2007 250 Honda CMX 250 C Rebel 2008 250 Honda CMX 250 C Rebel 2009 250
产品单重	220克			
检测程序	315			
电线插头	黄线20红黑线25CM			
内盒尺寸	12*9.5*6CM			
外箱尺寸	49.5*25.5*30.5CM			
输出电压	14.5±0.5V			
一箱只数	50			
铝壳尺寸				
重要说明	3黄1红1黑负			
产品编号	R2012A. 1. 5A		 <p>1. Power Coil 2. Power Coil 3. Power Coil</p> <p>4. GND 5. Battery (+)</p>	HONDA CA125 Rebel 125 1995-2000 CMX250C Rebel MC32A 1997 1998 1999 MC13B 1996 Honda CMX250C Rebel MC32A 1997-99 MC13B 1996 B7
产品单重	盒 重273克			
检测程序	315			
电线插头	黄线35红绿线50CM			
内盒尺寸	12*9.5*6CM			
外箱尺寸	49.5*25.5*30.5CM			
输出电压	14.5±0.5V			
一箱只数	50			
铝壳尺寸				
重要说明				
产品编号	R2012A. 1. 6		 <p>1. GND / Masa 2. Battery (+) / Bateria (+)</p> <p>3. Power Coil / Bobina de Carga 4. Power Coil / Bobina de Carga 5. Power Coil / Bobina de Carga</p>	SUZUKI DRZ400 DR-Z400 2000-2011 01 02 03 04 05
产品单重	220克			
检测程序	315			
电线插头	25CM			
内盒尺寸	12*9.5*6CM			
外箱尺寸	49.5*25.5*30.5CM			
输出电压	14.5±0.5V			
一箱只数	50			
铝壳尺寸				
重要说明				

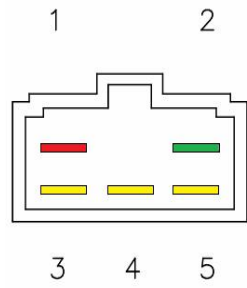
产品资料1		实物主图	接口图	适用范围
产品编号	R2012A. 1. 7		 <p>1. Ignition Switch/ Sensor 2. Battery (+) / Batería (+) 3. GND / Masa</p> <p>4. Power Coil / Bobina de Carga 5. Power Coil / Bobina de Carga 6. Power Coil / Bobina de Carga</p>	2345 25A Honda CX 500 1978 1981 31600-415-008 Reem lazo Shin ngen SH532-12
产品单重	220克			
检测程序	315 2345			
电线插头	25CM			
内盒尺寸	12*9. 5*6CM			
外箱尺寸	49. 5*25. 5*30. 5CM			
输出电压	14. 5±0. 5V 25安培			
一箱只数	50			
铝壳尺寸				
重要说明				
产品编号	R2012A. 1. 8		 <p>1. Power Coil / Bobina de 2. Power Coil / Bobina de 3. Power Coil / Bobina de</p> <p>4. Ignition Switch/ Sensor 5. Battery (+) / Batería (+) 6. GND / Masa</p>	59V-81960-A0-00 Yamaha SR 500 from 1978 to 1979 Yamaha YFM Moto-4 225 from 1986-1988 Yamaha YFM Moto-4 250 from 1989-1991 Yamaha YFM Warrior X 350 from 1987-1995 Yamaha YFM FW 350 from 1987-1989 Yamaha YFM Big Bear F 350 from 1990-1994 Honda CH125 Elite 125-149cc Honda CBT125 1982-1993
产品单重	220克			
检测程序	315			
电线插头	25CM			
内盒尺寸	12*9. 5*6CM			
外箱尺寸	49. 5*25. 5*30. 5CM			
输出电压	14. 5±0. 5V			
一箱只数	50			
铝壳尺寸				
重要说明				
产品编号	R2012A. 1. 9		 <p>1. Power Coil / Bobina de Carga 2. Power Coil / Bobina de Carga 3. Power Coil / Bobina de Carga</p> <p>4. Battery (+) / Batería (+) 5. GND / Masa</p>	2059 25A Honda XR L 650 1993 2009 31600-MY6-671 Honda XR L 650 2012 2017 31600-MY6-671 Reem lazo ietcard 1369 Reem lazo Shin ngen SH532C-13
产品单重	220克			
检测程序	315 2059			
电线插头	25CM			
内盒尺寸	12*9. 5*6CM			
外箱尺寸	49. 5*25. 5*30. 5CM			
输出电压	14. 5±0. 5V 25安培			
一箱只数	50			
铝壳尺寸				
重要说明				
产品编号	R2012A. 1. 10		 <p>1. Battery (+) / Batería (+) 2. GND / Masa</p> <p>3. Power Coil / Bobina de Carga 4. Power Coil / Bobina de Carga 5. Power Coil / Bobina de Carga</p>	Reemplazo Shindengen SH535C-12 Suzuki VX 800 de 1990 a 1993 32800-45C00 Suzuki VZ Marauder 800 de 1997 a 2004 32800-45C01
产品单重	220克			
检测程序	315			
电线插头	25CM			
内盒尺寸	12*9. 5*6CM			
外箱尺寸	49. 5*25. 5*30. 5CM			
输出电压	14. 5±0. 5V			
一箱只数	50			
铝壳尺寸				
重要说明				

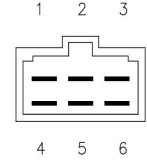

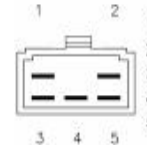

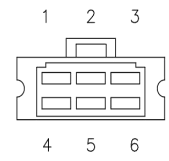

产品资料1		实物主图	接口图	适用范围
产品编号	R2012A. 1. 11		 <p>1. Battery (+) / Bateria (+) 2. GND / Masa</p> <p>3. Power Coil / Bobina de Carga 4. Power Coil / Bobina de Carga 5. Power Coil / Bobina de Carga</p>	Honda CBT125 1982-1993 Honda CMX450 1986-1988
产品单重	220克			
检测程序	315			
电线插头	25CM			
内盒尺寸	12*9.5*6CM			
外箱尺寸	49.5*25.5*30.5CM			
输出电压	14.5±0.5V			
一箱只数	50			
铝壳尺寸				
重要说明				
产品编号	R2012A. 1. 12		 <p>1. Battery (+) / Bateria (+) 2. GND / Masa</p> <p>3. Power Coil / Bobina de Carga 4. Power Coil / Bobina de Carga 5. Power Coil / Bobina de Carga</p>	HondaNXDominator650 1995 199931600-MAN-621 HondaNXDominator650200231600-MAN-621 Reem lazoShin ngenSH532
产品单重	220克			
检测程序	325 2547			
电线插头	45CM			
内盒尺寸	12*9.5*6CM			
外箱尺寸	49.5*25.5*30.5CM			
输出电压	14.5±0.5V 30安培			
一箱只数	50			
铝壳尺寸				
重要说明				
产品编号	R2012A. 1. 13		 <p>1. Battery (+) / Bateria (+) 2. GND / Masa</p> <p>3. Power Coil / Bobina de Carga 4. Power Coil / Bobina de Carga 5. Power Coil / Bobina de Carga</p>	HondaNXDominator650 1992 199431600-MY2-621 Reem lazoShin ngenSH532
产品单重	220克			
检测程序	325 2548			
电线插头	红绿15 黄线20CM			
内盒尺寸	12*9.5*6CM			
外箱尺寸	49.5*25.5*30.5CM			
输出电压	14.5±0.5V 25安培			
一箱只数	50			
铝壳尺寸				
重要说明				
产品编号	R2012A. 1. 14		 <p>1. Ignition Switch/ Sensor 2. Battery (+) / Bateria (+) 3. GND / Masa</p> <p>4. Power Coil / Bobina de Carga 5. Power Coil / Bobina de Carga 6. Power Coil / Bobina de Carga</p>	2058 25A Honda NX Dominator 650 1988 1991 31600-MN9-000 Reem lazo Shin ngen SH532B
产品单重	220克			
检测程序	325 2058			
电线插头	45CM			
内盒尺寸	12*9.5*6CM			
外箱尺寸	49.5*25.5*30.5CM			
输出电压	14.5±0.5V 25安培			
一箱只数	50			
铝壳尺寸				
重要说明				



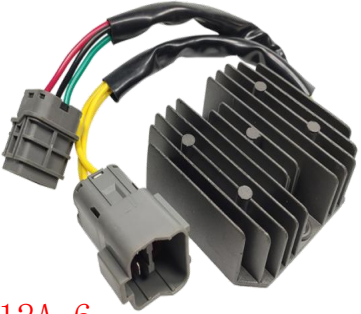
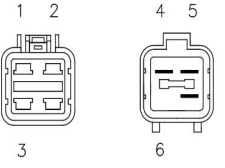

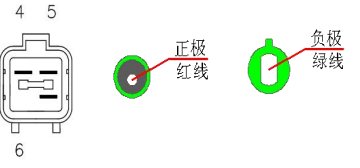
产品资料1		实物主图	接口图	适用范围
产品编号	R2012A. 2	 <p>R2012A. 2</p>	 <p>1. Battery (+) / Bateria (+) 2. GND / Masa 3. Ignition Switch / Sensor 4. Power Coil / Bobina de Carga 5. Power Coil / Bobina de Carga 6. Power Coil / Bobina de Carga</p> <p>R2012A. 2</p>	2340 Reem lazo Shin ngen SH235 Yamaha YFM Moto-4 225 1986 1988 59V-81960-A0-00 Yamaha YFM Moto-4 250 1989 1991 59V-81960-A0-00 Yamaha YFM FW 350 1987 1989 59V-81960-A0-00 Yamaha YFM Big Bear F 350 1990 1994 59V-81960-A0-00 Yamaha YFM Warrior X 350 1987 1995
产品单重	220克			
检测程序	315 2340			
电线插头	15CM			
内盒尺寸	12*9.5*6CM			
外箱尺寸	49.5*25.5*30.5CM			
输出电压	14.5±0.5V 25安培			
一箱只数	50			
铝壳尺寸				
重要说明				
产品编号	R2012A. 3	 <p>R2012A. 3</p>	 <p>1. Battery (+) 2. GND 3. Power Coil 4. Power Coil 5. Power Coil</p> <p>R2012A. 3</p>	MBK Skyliner 180 2002 2010 4HM-81960-00 MBK Skyliner 125 2002 2010 4HM-81960-00 MBK Skyliner 150 2002 2010 4HM-81960-00 Suzuki DR SE 650 1996 2017 32800-32E00 Suzuki XF Freewind 650 s 1997 32800-32E00 Yamaha Flame X 125 4HM-81960-00
产品单重	220克			
检测程序	315			
电线插头	5针插头			
内盒尺寸	12*9.5*6CM			
外箱尺寸	49.5*25.5*30.5CM			
输出电压	14.5±0.5V			
一箱只数	50			
铝壳尺寸				
重要说明				
产品编号	R2012A. 3. 1	 <p>R2012A. 3. 1</p>	<p>常用款</p>  <p>1. Battery (+) / Bateria (+) 2. Ignition Switch / Sensor 3. GND / Masa 4. Power Coil / Bobina de Carga 5. Power Coil / Bobina de Carga 6. Power Coil / Bobina de Carga</p> <p>R2012A. 3. 1</p>	2443 KawasakiKEFLakota300 1995 200021066-1089 KawasakiKEFLakota S ort300 2001 200321066-1089 KawasakiKFX300 2001 200421066-1089 KawasakiKLFBayou300 1988 199121066-1101 KawasakiKLFBayou 4x4300 1989 2002 21066-1089 KawasakiKLFBayou300 1988 199121066-
产品单重	220克			
检测程序	315 2443			
电线插头	6针插头			
内盒尺寸	12*9.5*6CM			
外箱尺寸	49.5*25.5*30.5CM			
输出电压	14.5±0.5V 25安培			
一箱只数	50			
铝壳尺寸				
重要说明				
产品编号	R2012A. 3. 2	 <p>R2012A. 3. 2</p>	 <p>1. Battery (+) / Bateria (+) 2. Ignition Switch / Sensor 3. GND / Masa 4. Power Coil / Bobina de Carga 5. Power Coil / Bobina de Carga</p> <p>R2012A. 3. 2</p>	Honda H 5013 A2/AC2 A4/AC4 31600-890-951 / SH547-12 Honda HT 3810 Lawn Tractor 31600-890-951 / SH547-12 Honda HT 3813 Lawn Tractor 31600-890-951 / SH547-12 Honda HT 4213 Lawn Tractor 31600-890-951 / SH547-12 Honda RT 5000 31600-890-951 / SH547-12
产品单重	220克			
检测程序	215 2320			
电线插头	5针插头			
内盒尺寸	12*9.5*6CM			
外箱尺寸	49.5*25.5*30.5CM			
输出电压	14.5±0.5V 20安培			
一箱只数	50			
铝壳尺寸				
重要说明				

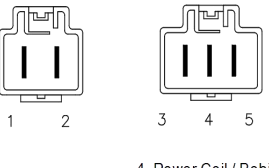

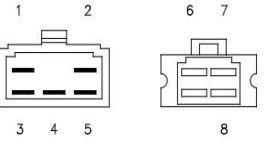

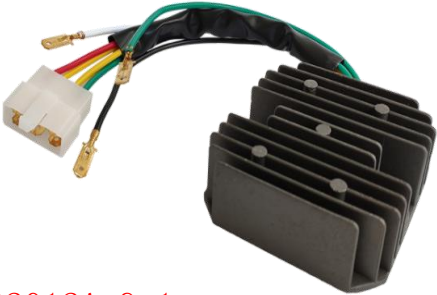
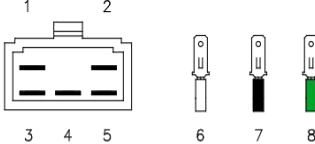
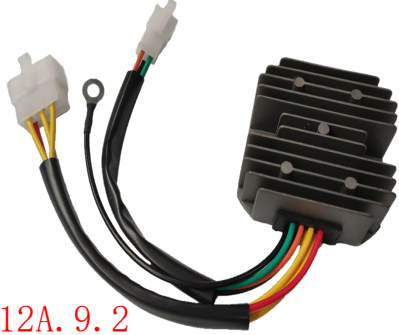
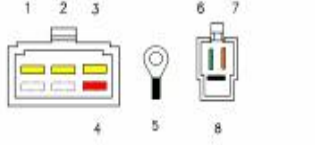

产品资料1		实物主图	接口图	适用范围
产品编号	R2012A. 4		 <p>1. Battery (+) 2. GND 3. Power Coil 4. Power Coil 5. Power Coil</p>	2543 Gas Gas Wild H 450 de 2003 a 2007 MFS400134009 Suzuki AN Burgman 400 de 1999 a 2002 32800-14F01 Suzuki AN Burgman 250 de 1998 a 2002 32800-14F00 Suzuki DR S 800 de 1990 a 1995 32800-34A01 Suzuki DR RSE 650 de 1991 a 1996 32800-34A01
产品单重	230克			
检测程序	315 2543			
电线插头	20CM			
内盒尺寸	12*9.5*6CM			
外箱尺寸	49.5*25.5*30.5CM			
输出电压	14.5±0.5V 35安培			
一箱只数	50			
铝壳尺寸				
重要说明				
产品编号	R2012A. 4. 1		 <p>1. Battery (+) / Bateria (+) 2. Ignition Switch / Sensor 3. GND / Masa 4. Power Coil / Bobina de Carga 5. Power Coil / Bobina de Carga 6. Power Coil / Bobina de Carga</p>	OEM 21066-1083 KAWASAKI ZX600 ZX 600 D2-D4 NINJA ZX-6R 2001-2003
产品单重	220克			
检测程序	315			
电线插头	15CM			
内盒尺寸	12*9.5*6CM			
外箱尺寸	49.5*25.5*30.5CM			
输出电压	14.5±0.5V 15安培			
一箱只数	50			
铝壳尺寸				
重要说明	3黄1红1黑1棕检测			
产品编号	R2012A. 4. 2		 <p>1. Battery (+) / Bateria (+) 2. GND / Masa 3. Power Coil / Bobina de Carga 4. Power Coil / Bobina de Carga 5. Power Coil / Bobina de Carga</p>	OEM 0453025 0453375 0452760 VoorPolaris 0452760 VoorPolaris 0453025 VoorPolaris 0453375 VoorPolaris 0455311 VoorPolaris hoenix 200 2005-2017 VoorPolaris Zaagtand 200 2006-2007 Polaris hoenix 200 2005-2014 Polaris hoenix 200 Quadricycle
产品单重	220克			
检测程序	315			
电线插头	20CM			
内盒尺寸	12*9.5*6CM			
外箱尺寸	49.5*25.5*30.5CM			
输出电压	14.5±0.5V 25安培			
一箱只数	50			
铝壳尺寸				
重要说明	3黄1红1黑负			
产品编号	R2012A. 4. 3		 <p>1. Ignition Switch / Sensor 2. Battery (+) / Bateria (+) 3. GND / Masa 4. Power Coil / Bobina de Carga 5. Power Coil / Bobina de Carga 6. Power Coil / Bobina de Carga</p>	2068 25A Kawasaki - 21066-1028 Kawasaki BJ Estrella 250 1994 21066-1030 Kawasaki EL Eliminator 250 1988 2003 21066-1030 Kawasaki EL HS 250 1991 1994 21066-1030 Kawasaki EN LTD 454 1985 1990 21066-1030 Kawasaki EN Vulcan 400 1989 1994
产品单重	220克			
检测程序	315 2077 2068			
电线插头	20CM			
内盒尺寸	12*9.5*6CM			
外箱尺寸	49.5*25.5*30.5CM			
输出电压	14.5±0.5V 25安培			
一箱只数	50			
铝壳尺寸				
重要说明	3黄1红1黑1棕检测			

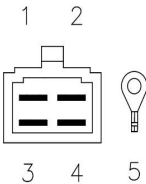
产品资料1		实物主图	接口图	适用范围
产品编号	R2012A. 5		 <p>1. Power Coil / Bobina de Carga 2. Power Coil / Bobina de Carga 3. Power Coil / Bobina de Carga 4. Battery (+) / Bateria (+) 5. GND / Masa</p>	2341 25A Honda TRX Fourtrax 300 1993 2000 31600-HC5-970 Honda TRX Fourtrax FW 300 1993 2000 31600-HC5-970 Reem lazo Shin ngen SH532C-13
产品单重	220克			
检测程序	315 2341			
电线插头	20CM			
内盒尺寸	12*9.5*6CM			
外箱尺寸	49.5*25.5*30.5CM			
输出电压	14.5±0.5V 25安培			
一箱只数	50			
铝壳尺寸				
重要说明	3黄1红1黑			
产品编号	R2012A. 5F		 <p>1. Battery (+) / Bateria (+) 2. GND / Masa 3. Power Coil / Bobina de Carga 4. Power Coil / Bobina de Carga 5. Power Coil / Bobina de Carga</p>	2628 35A Honda TRX Sportrax EX 300 de 1993 a 2004 31600-HM3-003 Reemplazo Shindengen SH532C-13
产品单重	220克			
检测程序	325 2628			
电线插头	25CM			
内盒尺寸	12*9.5*6CM			
外箱尺寸	49.5*25.5*30.5CM			
输出电压	14.5±0.5V 35安培			
一箱只数	50			
铝壳尺寸				
重要说明	3黄1红1绿			
产品编号	R2012A. 5. 1		 <p>1. Ignition Switch/ Sensor 2. Battery (+) / Bateria (+) 4. Power Coil / Bobina de Carga 5. Power Coil / Bobina de Carga 6. Power Coil / Bobina de Carga</p>	YUC085/ Honda AVT TRX300 EX S ORTRAX 300EX 2001-2006 FOURTRAX 300 EX 1993- 20
产品单重	220克			
检测程序	325			
电线插头	20 50CM			
内盒尺寸	12*9.5*6CM			
外箱尺寸	49.5*25.5*30.5CM			
输出电压	14.5±0.5V			
一箱只数	50			
铝壳尺寸				
重要说明				
产品编号	R2012A. 5. 2		 <p>1. Ignition Switch/ Sensor 2. Battery (+) / Bateria (+) 3. GND / Masa 4. Power Coil / Bobina de Carga 5. Power Coil / Bobina de Carga 6. Power Coil / Bobina de Carga</p>	Honda TRX Fourtrax 300 1988 1992 31600-HC4-010 / SH532B-12 Honda TRX Fourtrax FW 4x4 300 1988 31600-HC4-010 / SH532B-12 Honda TRX Fourtrax FW 4x4 300 1990 1992 31600-HC4-010 / SH532B-12
产品单重	220克			
检测程序	325 2342			
电线插头	20 50CM			
内盒尺寸	12*9.5*6CM			
外箱尺寸	49.5*25.5*30.5CM			
输出电压	14.5±0.5V 25安培			
一箱只数	50			
铝壳尺寸				
重要说明				

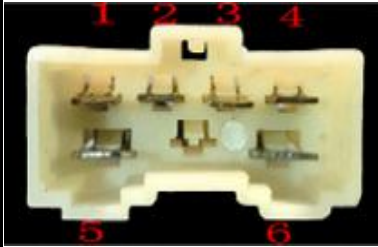

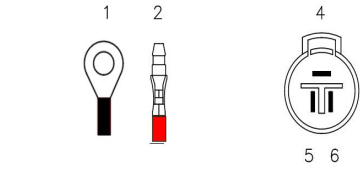

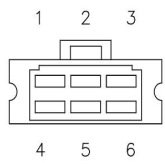

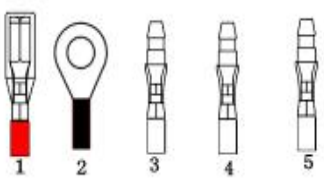
产品资料1		实物主图	接口图	适用范围
产品编号	R2012A. 5. 3		 <p>1. Power Coil / Bobina de Carga 2. Power Coil / Bobina de Carga 3. Power Coil / Bobina de Carga 4. GND / Masa 5. GND / Masa 6. Ignition Switch / Sensor 7. Battery (+) / Bateria (+)</p>	2456 HondaATCES / SX250 1985 198731600- HA0-000 HondaTRX250 1985 198731600-HA8-770
产品单重	220克			
检测程序	325 2456			
电线插头	20CM			
内盒尺寸	12*9.5*6CM			
外箱尺寸	49.5*25.5*30.5CM			
输出电压	14.5±0.5V 25安培			
一箱只数	50			
铝壳尺寸				
重要说明				
产品编号	R2012A. 5. 4		 <p>1. Battery (+) / Bateria (+) 2. Ignition Switch / Sensor 3. GND / Masa 4. Power Coil / Bobina de Carga 5. Power Coil / Bobina de Carga 6. Power Coil / Bobina de Carga</p>	Buyang Feishen Xingyue Linhai 300cc D300 ATV 300 BUYANG FA-D300 H300 ATVs Quad Bike Jian She 400CC ATV 飞神300整流器FS林 海260
产品单重	净重236克，盒重260克			
检测程序	325			
电线插头	2025CM			
内盒尺寸	12*9.5*6CM			
外箱尺寸	49.5*25.5*30.5CM			
输出电压	14.5±0.5V			
一箱只数	50			
铝壳尺寸				
重要说明				
产品编号	R2012A. 5. 5			2433 JiansheATV250 MotomeIQuest250 ZanellaG-ce250
产品单重	220克			
检测程序	315 2433			
电线插头	20CM			
内盒尺寸	12*9.5*6CM			
外箱尺寸	49.5*25.5*30.5CM			
输出电压	14.5±0.5V 12安培			
一箱只数	50			
铝壳尺寸				
重要说明				
产品编号	R2012A. 5. 6		 <p>1. Battery (+) / Bateria (+) 2. GND / Masa 3. Power Coil / Bobina de Carga 4. Power Coil / Bobina de Carga 5. Power Coil / Bobina de Carga</p>	BUYANG FA-D300
产品单重	净重 222克			
检测程序	325			
电线插头	20CM			
内盒尺寸	12*9.5*6CM			
外箱尺寸	49.5*25.5*30.5CM			
输出电压	14.5±0.5V			
一箱只数	50			
铝壳尺寸				
重要说明				

产品资料1		实物主图	接口图	适用范围
产品编号	R2012A. 6		 <p>1. Ignition Switch / Sensor 2. Battery (+) / Bateria (+) 3. GND / Masa</p> <p>4. Power Coil / Bobina de Carga 5. Power Coil / Bobina de Carga 6. Power Coil / Bobina de Carga</p>	2468 Arctic CatUtility250 2006 20093303-836 Arctic CatUtility300 2010 20163303-836 Arctic CatUtility150 2009 20193303-836 Can AmDS250 2006 2015S31600RCA000 KymcoMXU250 2004 200831600-LBA7-900 KymcoMXU300 2005 201131600-LBA7-900 KymcoMXU150 2005 201131600-LBA7-900
产品单重	220克			
检测程序	M325 2468 2467			
电线插头	25CM			
内盒尺寸	12*9.5*6CM			
外箱尺寸	49.5*25.5*30.5CM			
输出电压	14.5±0.5V 35安培			
一箱只数	50			
铝壳尺寸				
重要说明				
产品编号	R2012A. 6. 1		 <p>4. Power Coil / Bobina de Carga 5. Power Coil / Bobina de Carga 6. Power Coil / Bobina de Carga</p>	Kymco MXU 300 05-11 MXU 250 04-08 MXU 150 05-11 KYMCO MXU250 2004-2007 31600-LBA7-900 KYMCO UXV 500/MXU 500/4X4 IRS (2010~2014) Adly ATV/Quad 300 S ort 2004-2005 Adly ATV/Quad 300 Utility 2004-2005 Adly ATV/Quad 300 XS Hurricane 2007-2010 Adly ATV/Quad 300 Interceptor 2007-2010
产品单重	220克			
检测程序	325			
电线插头	25CM			
内盒尺寸	12*9.5*6CM			
外箱尺寸	49.5*25.5*30.5CM			
输出电压	14.5±0.5V			
一箱只数	50			
铝壳尺寸				
重要说明				
产品编号	R2012A. 7		 <p>1. GND / Masa 2. Battery (+) / Bateria (+) 3. Power Coil / Bobina de Carga</p> <p>4. Power Coil / Bobina de Carga 5. Power Coil / Bobina de Carga</p>	HONDA CBR1000RR CBR 1000RR VOLTAGE REGULATOR RECTIFIER 05 06 07 08 09 2007-2012 HONDA CBR600RR 2004-2007 HONDA CBR1000RR
产品单重	220克			
检测程序	315			
电线插头	25CM			
内盒尺寸	12*9.5*6CM			
外箱尺寸	49.5*25.5*30.5CM			
输出电压	14.5±0.5V			
一箱只数	50			
铝壳尺寸				
重要说明				
产品编号	R2012A. 9		 <p>1. Field Coil / Bobina de Campo 2. Ignition Switch / Sensor 3. Power Coil / Bobina de Carga 4. Power Coil / Bobina de Carga</p> <p>5. Power Coil / Bobina de Carga 6. GND / Masa 7. Battery (+) / Bateria (+) 8. Ignition Switch / Sensor</p>	2514 HondaCBSC NightHawk700 1984 1986 31600-MJ1-780 HondaCBX E750198431600-MJ1-671 HondaCBX 2750 1994 199831600-MJ1-672 HondaCBX 2H750198731600-MJ1-672 HondaCBX 21750200131600-MJ1-672 Reem lazoShingenSH255-12
产品单重	250克			
检测程序	CB750+励磁 2514			
电线插头	35CM			
内盒尺寸	12*9.5*6CM			
外箱尺寸	49.5*25.5*30.5CM			
输出电压	14.5±0.5V 25安培			
一箱只数	50			
铝壳尺寸				
重要说明				



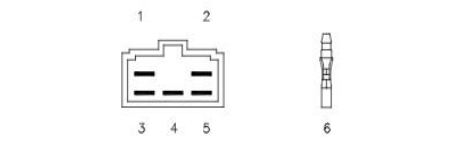

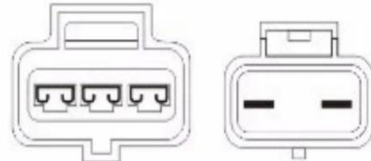
产品资料1		实物主图	接口图	适用范围
产品编号	R2012A. 9. 1		 <p>1. Battery (+) / Bateria (+) 2. GND / Masa 3. Power Coil / Bobina de Carga 4. Power Coil / Bobina de Carga 5. Power Coil / Bobina de Carga 6. Field Coil / Bobina de Campo (White/ Blanco) 7. Ignition Switch / Sensor (Black/ Negro) 8. GND / Masa (Green/ Verde) CAMPO +</p>	2330 25A CAM 0 + Honda CB F 400 1976 1978 31400-333-004 Honda CB F 350 1972 1975 Honda CB K 500 1971 1973 Honda CB F Su er S ort 550 1975 1977 31400-300-035 Honda CB Hondamatic 750 1976 1978 31400-300-035 Honda CB F Su er S ort SOHC 750 1975 1978 31400-300-035
产品单重	240克			
检测程序	CB750+励磁 10007			
电线插头	25CM			
内盒尺寸	12*9. 5*6CM			
外箱尺寸	49. 5*25. 5*30. 5CM			
输出电压	14. 5±0. 5V 25安培			
一箱只数	50			
铝壳尺寸				
重要说明				
产品编号	R2012A. 9. 2		 <p>1. Power Coil / Bobina de Carga 2. Power Coil / Bobina de Carga 3. Power Coil / Bobina de Carga 4. Battery (+) / Bateria (+) 5. GND / Masa 6. Field Coil / Bobina de Campo 7. Ignition Switch / Sensor 8. GND / Masa</p>	SUZUKI GT380 GT550 GT750 GT 380 550 750 SUZUKI TS 400 TS400 1972-1977 32800-31021 32800-37010
产品单重	240克			
检测程序	CB750+励磁 10007			
电线插头	25CM			
内盒尺寸	12*9. 5*6CM			
外箱尺寸	49. 5*25. 5*30. 5CM			
输出电压	14. 5±0. 5V 25安培			
一箱只数	50			
铝壳尺寸				
重要说明				
产品编号	R2012A. 10		 <p>1. Power Coil / Generator 2. Power Coil / Generator 3. Power Coil / Generator 4. Battery (-) / Bateria (-) 5. Battery (+) / Bateria (+)</p>	cfmoto电喷春风水冷摩托车150NK调压整流器CF150-3
产品单重	220克			
检测程序	M325			
电线插头	25CM			
内盒尺寸	12*9. 5*6CM			
外箱尺寸	49. 5*25. 5*30. 5CM			
输出电压	14. 5±0. 5V			
一箱只数	50			
铝壳尺寸				
重要说明				
产品编号	R2012A. 11		 <p>1. Battery (+) / Bateria (+) 2. Power Coil / Bobina de Carga 3. Power Coil / Bobina de Carga 4. Power Coil / Bobina de Carga 5. GND / Masa</p>	2556 Suzuki LT QuadRunner 230 1987 1993 32800-35B00
产品单重	220克			
检测程序	315 2556			
电线插头	25CM 绿线20CM			
内盒尺寸	12*9. 5*6CM			
外箱尺寸	49. 5*25. 5*30. 5CM			
输出电压	14. 5±0. 5V 20安培			
一箱只数	50			
铝壳尺寸				
重要说明				

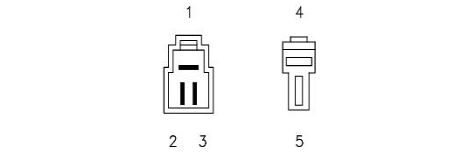



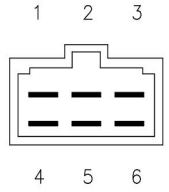
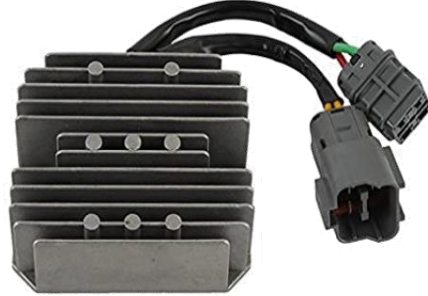
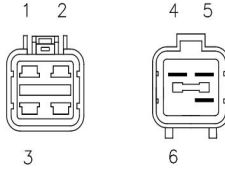

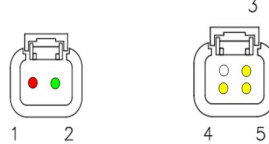
产品资料1		实物主图	接口图	适用范围
产品编号	R2012A.12		 1. 检测 2. AC 3. AC 4. AC 5. 正极 6. 负极	Kawasaki ZX-9R整流器 YHC093 SH579A-12 A llocation: Kawasaki VN1500 Vulcan & ZX900C ZX9R Kawasaki ZX-9R (ZX900B1/2) 1998-1999 KAWASAKI rairie 400 KVF400 1998
产品单重	220克			
检测程序	M325			
电线插头	20CM			
内盒尺寸	12*9.5*6CM			
外箱尺寸	49.5*25.5*30.5CM			
输出电压	14.5±0.5V			
一箱只数	50			
铝壳尺寸				
重要说明				
产品编号	R2012A.13		 1. GND / Masa 2. Battery (+) / Batería (+) 4. Power Coil / Bobina de Carga 5. Power Coil / Bobina de Carga 6. Power Coil / Bobina de Carga	Yamaha 67F-81960-12 Mercury 804278A12, 804278T11
产品单重	220克			
检测程序	315			
电线插头	25CM			
内盒尺寸	12*9.5*6CM			
外箱尺寸	49.5*25.5*30.5CM			
输出电压	14.5±0.5V			
一箱只数	50			
铝壳尺寸				
重要说明				
产品编号	R2012A.14		 1. Ignition Switch / Sensor 2. Battery (+) / Batería (+) 3. GND / Masa 4. Power Coil / Bobina de Carga 5. Power Coil / Bobina de Carga 6. Power Coil / Bobina de Carga	KAWASAKI: EL250, G X250, G Z250R, ZR400R*, EN450/454, EX500, KLE500, GT550, KZ550, Z550LTD*, ZR550F*, G Z750 Ninja/Turbo, GT750, Z750 Turbo*, ZL900, Z1000/J/R/LTD/MKII/ST, ZL1000, G Z1100 Unitrak, G Z1100, Z1100G /LTD/R/ST YAMAHA: RD250E, RD350E, RD400E, YFB250*, YFM225, YFU1W
产品单重	220克			
检测程序	315			
电线插头	20CM			
内盒尺寸	12*9.5*6CM			
外箱尺寸	49.5*25.5*30.5CM			
输出电压	14.5±0.5V			
一箱只数	50			
铝壳尺寸				
重要说明	3黄1红1 黑1棕检测			
产品编号	R2012A.15		 1. Battery (+) 2. GND 3. Power Coil 4. Power Coil 5. Power Coil	Kawasaki: Z900, Z1000A/A1, Z1R Suzuki: DR250, DR650R, DR650RE, DR650RS, DR750S, DR800S, GN125, GN250, GN400, GR650, GS250, GS400, GS425, GS450E, GS450L, GS550, GS550L, GS650E, GS650L, GS750E, GS750L, GS850GL, GS850GT, GS1000GL, GS1000GT, GS1000 Katana, GSX240, GSX250, GSX400T, GSX1100, GT550, GZ125, RV125, VL125 Yamaha: XVS125 Laverda: RGS1000,
产品单重	220克			
检测程序	315			
电线插头	25CM			
内盒尺寸	12*9.5*6CM			
外箱尺寸	49.5*25.5*30.5CM			
输出电压	14.5±0.5V			
一箱只数	50			
铝壳尺寸				
重要说明	3白1红1黑			

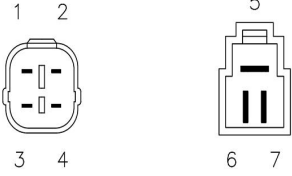

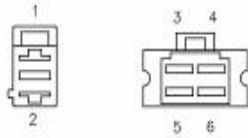
产品资料1		实物主图	接口图	适用范围
产品编号	R2012A.16		 <ul style="list-style-type: none"> 1. Power Coil / Bobina de Carga 2. Battery (+) / Bateria (+) 3. Power Coil / Bobina de Carga 4. Power Coil / Bobina de Carga 5. GND / Masa 	Suzuki: GSX750/E/L/S, GSX1000/E, GSX1100/LS
产品单重	220克			
检测程序	315			
电线插头	25CM			
内盒尺寸	12*9.5*6CM			
外箱尺寸	49.5*25.5*30.5CM			
输出电压	14.5±0.5V			
一箱只数	50			
铝壳尺寸				
重要说明	3黄1红1黑			
产品编号	R2012A.17		 <ul style="list-style-type: none"> 1. Power Coil / Bobina de Carga 2. Battery (+) / Bateria (+) 3. Power Coil / Bobina de Carga 4. Power Coil / Bobina de Carga 5. GND / Masa 	Suzuki: GS550L, GSX550, GSX750, XN850
产品单重	220克			
检测程序	315			
电线插头	25CM			
内盒尺寸	12*9.5*6CM			
外箱尺寸	49.5*25.5*30.5CM			
输出电压	14.5±0.5V			
一箱只数	50			
铝壳尺寸				
重要说明	3黄1红1黑			
产品编号	R2012A.18		 <ul style="list-style-type: none"> 1. Power Coil / Bobina de Carga 2. Battery (+) / Bateria (+) 3. Power Coil / Bobina de Carga 4. GND / Masa 	
产品单重	240克			
检测程序	208			
电线插头	25CM			
内盒尺寸	12*9.5*6CM			
外箱尺寸	49.5*25.5*30.5CM			
输出电压	14.5±0.5V			
一箱只数	50			
铝壳尺寸				
重要说明	2黄1红1绿 4插 带钩			
产品编号	R2012A.18.1		 <ul style="list-style-type: none"> 1. Power Coil / Bobina de Carga 2. Battery (+) / Bateria (+) 3. Power Coil / Bobina de Carga 4. GND / Masa 	
产品单重	220克			
检测程序	208			
电线插头	25CM			
内盒尺寸	12*9.5*6CM			
外箱尺寸	49.5*25.5*30.5CM			
输出电压	14.5±0.5V			
一箱只数	50			
铝壳尺寸				
重要说明	2黄1红1绿 4插不带钩			

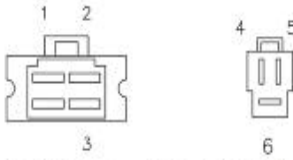

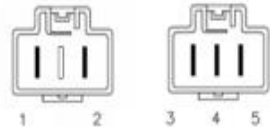

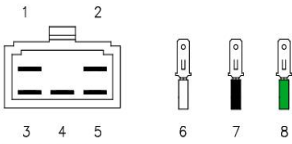
产品资料1		实物主图	接口图	适用范围
产品编号	R2012A.19		 <p>1. GND / Masa 2. Battery (+) / Bateria (+) 3. Power Coil / Bobina de Carga 5. Power Coil / Bobina de Carga 8. Power Coil / Bobina de Carga</p>	31600-MAK-000 Honda FX 650 Vigor 1999- 2000 Honda FX 650 Vigor 1999- 2000 Honda SLR 650 # RD09A # 1997 Honda SLR 650 # RD09A # 1998 Honda SLR 650 # RD09C # 1997 Honda SLR 650 # RD09C # 1998
产品单重	220克			
检测程序	325			
电线插头	20CM			
内盒尺寸	12*9.5*6CM			
外箱尺寸	49.5*25.5*30.5CM			
输出电压	14.5±0.5V			
一箱只数	50			
铝壳尺寸				
重要说明				
产品编号	R2012A.20		 <p>1. Ignition Switch/ Sensor 2. GND / Masa 3. Power Coil / Bobina de Carga 4. Power Coil / Bobina de Carga 5. Power Coil / Bobina de Carga 6. Battery (+) / Bateria (+)</p>	Kawasaki KZ LTD 750 1980 1983 21066-1027 Kawasaki KZ olice 1000 1979 1981 21066-1008 Kawasaki KZ CSR 1000 1981 1982 21066-1008 Kawasaki KZ 750 1980 1982 21066-1008 Kawasaki KZ CSR 650 1981 1983 21066-1027 Kawasaki KZ Classic 1000 1980 21066-
产品单重	220克			
检测程序	315			
电线插头	25CM			
内盒尺寸	12*9.5*6CM			
外箱尺寸	49.5*25.5*30.5CM			
输出电压	14.5±0.5V			
一箱只数	50			
铝壳尺寸				
重要说明	3黄1红1黑1棕检测			
产品编号	R2012A.21			钱江贝纳利 小黄龙BJ250-15/15A QJ198MR-2235170410 Benali BN251 TNT25
产品单重	236克			
检测程序	M325			
电线插头	20CM			
内盒尺寸	12*9.5*6CM			
外箱尺寸	49.5*25.5*30.5CM			
输出电压	14.5±0.5V			
一箱只数	50			
铝壳尺寸				
重要说明				
产品编号	R2012A.22		 <p>1. Power Coil / Bobina de Carga 2. Power Coil / Bobina de Carga 3. Power Coil / Bobina de Carga 4. Battery (+) / Bateria (+) 5. Battery (-) / Bateria (-)</p>	2466 Hyosung GT S / R FI 650 2007 2013 32800HN9101 Hyosung GT /R 250 2008 2013 32800HN9110 Hyosung GT /R FI 250 2010 2013 32800HN9110 Hyosung GV Mirage 650 2007 2013 32800HN9101 Hyosung GV Comet 650 2007 2013 32800HN9101
产品单重	净重230克			
检测程序	325 2466			
电线插头	20CM			
内盒尺寸	12*9.5*6CM			
外箱尺寸	49.5*25.5*30.5CM			
输出电压	14.5±0.5V 35安培			
一箱只数	50			
铝壳尺寸				
重要说明				

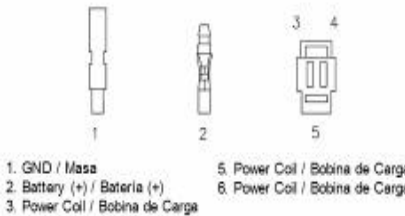
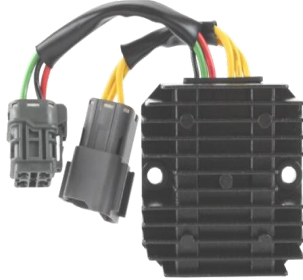
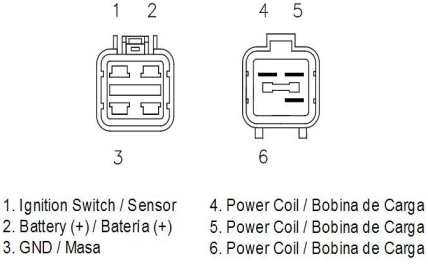
产品资料1		实物主图	接口图	适用范围
产品编号	R2012A. 23	 <p>R2012A. 23</p>	 <p>1. Power Coil / Bobina de Carga 2. Power Coil / Bobina de Carga 3. Power Coil / Bobina de Carga 4. GND / Masa 5. Battery (+) / Bateria (+)</p> <p>R2012A. 23</p>	2408 20A Reem lazo Shin ngen SH572MB Suzuki AN 125 2000 32800-22D11 Suzuki AN Burgman 250 1996 2000 32800-22D10 Suzuki AN Burgman 125 1995 2000 32800-22D10 Suzuki EN 125 2004 2008 32800-22D20 Suzuki EN A2 125 32800-37G10-000 Suzuki GN 125 32800-37G10-000 Suzuki GSX 250 1991 1997 32800-
产品单重	克			
检测程序	315 2408			
电线插头	25 CMX 1平方 3黄1红1黑			
内盒尺寸	12*9.5*6CM			
外箱尺寸	49.5*25.5*30.5CM			
输出电压	14.5±0.5V 20安培 25安培			
一箱只数	50			
铝壳尺寸				
重要说明				
产品编号	R2012A. 24	 <p>R2012A. 24</p>	 <p>1. Battery (+) 2. GND 3. Power Coil 4. Power Coil 5. Power Coil</p> <p>R2012A. 24</p>	AEO-31600213-00 Aeon CROSSLAND 350 AEon cobra 4x4 400cc OE号: 31600215-000 Scooters Daelim 125 B-Bone 2009 To
产品单重	净重234克			
检测程序	M325			
电线插头	20CM			
内盒尺寸	12*9.5*6CM			
外箱尺寸	49.5*25.5*30.5CM			
输出电压	14.5±0.5V			
一箱只数	50			
铝壳尺寸				
重要说明				
产品编号	R2012A. 25	 <p>R2012A. 25</p>	 <p>1. Battery (+) 2. GND 3. Power Coil 4. Power Coil 5. Power Coil</p> <p>R2012A. 25</p>	Yamaha FZR600 - '95-99 Yamaha YZF R1 - '98-01 Yamaha YZF R6 - '99-02 Yamaha YZF600 - '95-00 & '02-06 Yamaha YZF R1 - '98-01 Yamaha YZF R6 - '99-02 Yamaha YZF600 - '95-00 & '02-06
产品单重				
检测程序	325			
电线插头	20CM			
内盒尺寸	12*9.5*6CM			
外箱尺寸	49.5*25.5*30.5CM			
输出电压	14.5±0.5V			
一箱只数	50			
铝壳尺寸				
重要说明				
产品编号	R2012C. 1	 <p>R2012C. 1</p>	 <p>1. Battery (+) 2. GND 3. Power Coil 4. Power Coil 5. Power Coil</p> <p>R2012C. 1</p>	Yamaha FZR600 - '95-99 Yamaha YZF R1 - '98-01 Yamaha YZF R6 - '99-02 Yamaha YZF600 - '95-00 & '02-06 Yamaha YZF R1 - '98-01 Yamaha YZF R6 - '99-02 Yamaha YZF600 - '95-00 & '02-06
产品单重	220克			
检测程序	M325			
电线插头	5针插头			
内盒尺寸	12*9.5*6CM			
外箱尺寸	49.5*25.5*30.5CM			
输出电压	14.5±0.5V			
一箱只数	50			
铝壳尺寸				
重要说明	5针插头			

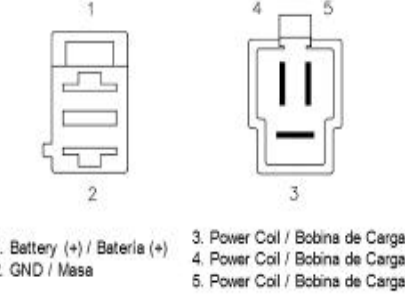

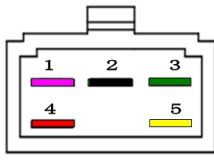
产品资料1		实物主图	接口图	适用范围
产品编号	R2012C. 1A		 <ol style="list-style-type: none"> 1. Battery (+) / Bateria (+) 2. Ignition Switch / Sensor 3. GND / Masa 4. Power Coil / Bobina de Carga 5. Power Coil / Bobina de Carga 6. Power Coil / Bobina de Carga 	KAWASAKI VN700A Vulcan 1985 KAWASAKI VN750A Vulcan 1986 - 1993 KAWASAKI ZL600A 1986 - 1987 KAWASAKI ZL600A 1996 - 1997 KAWASAKI ZN1100B Ltd 1983 - 1985 KAWASAKI ZN700A Ltd 1984 - 1985 KAWASAKI ZX600A Ninja 600R 1986 - 1987 KAWASAKI ZX600B Ninja 600RX 1987
产品单重	220克			
检测程序	M325 2443			
电线插头	6针插头			
内盒尺寸	12*9.5*6CM			
外箱尺寸	49.5*25.5*30.5CM			
输出电压	14.5±0.5V 25安培			
一箱只数	50			
铝壳尺寸				
重要说明	6针插头			
产品编号	R2012C. 2		 <ol style="list-style-type: none"> 1. Ignition Switch / Sensor 2. Battery (+) / Bateria (+) 3. GND / Masa 4. Power Coil / Bobina de Carga 5. Power Coil / Bobina de Carga 6. Power Coil / Bobina de Carga 	Arctic Cat Utility 250 2006 2009 3303-836 Arctic Cat Utility 300 2010 2016 3303-836 Arctic Cat Utility 150 2009 2019 3303-836 Can Am DS 250 2006 2015 S3160ORCA000 Kymco MXU 250 2004 2008 31600-LBA7-900 Kymco MXU 300 2005 2011 31600-
产品单重	220克			
检测程序	M325 2467 2468			
电线插头	25CM			
内盒尺寸	12*9.5*6CM			
外箱尺寸	49.5*25.5*30.5CM			
输出电压	14.5±0.5V 35安培			
一箱只数	50			
铝壳尺寸				
重要说明				
产品编号	R2012C. 3		 <ol style="list-style-type: none"> 1. Battery (+) / Bateria (+) 2. GND / Masa 3. Power Coil / Bobina de Carga 4. Power Coil / Bobina de Carga 5. Power Coil / Bobina de Carga 	Ski Doo S I-S ort art SM-01141 Ski-Doo MXZ600 HO MXZ800 Re laces OEM # 515175968 515-1759-68
产品单重	220克			
检测程序	M325			
电线插头	所有1.5 X 20CM			
内盒尺寸	12*9.5*6CM			
外箱尺寸	49.5*25.5*30.5CM			
输出电压	14.5±0.5V			
一箱只数	50			
铝壳尺寸				
重要说明				
产品编号	R2012C. 4		 <ol style="list-style-type: none"> 1. Battery (+) / Bateria (+) 2. Battery (+) / Bateria (+) 3. GND / Masa 4. GND / Masa 5. Power Coil / Bobina de Carga 6. Power Coil / Bobina de Carga 7. Power Coil / Bobina de Carga 	32800-44D31 479065300
产品单重	克			
检测程序	M325			
电线插头	黑1.5 X 25CM			
内盒尺寸	12*9.5*6CM			
外箱尺寸	49.5*25.5*30.5CM			
输出电压	14.5±0.5V			
一箱只数	50			
铝壳尺寸				
重要说明				

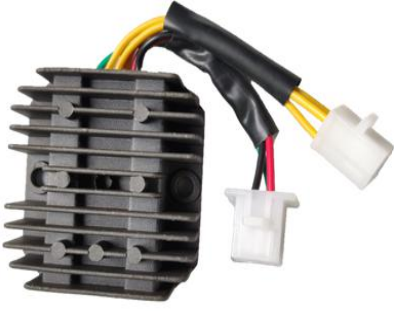
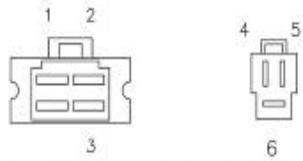

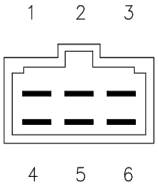

产品资料1		实物主图	接口图	适用范围
产品编号	R2012C. 5		 <p>1. Battery (+) / Bateria (+) 2. GND/ Masa 3. Power Coil / Bobina de Carga 4. Power Coil / Bobina de Carga 5. Ignition Switch / Sensor 6. Power Coil / Bobina de Carga</p>	2554 Kymco AK 550 31600-LKF5-E00 Kymco K-XCT 125 31600-LKF5-E00 Kymco Xciting 4T 400 31600-LKF5-E00
产品单重	克			
检测程序	M325 2554			
电线插头	黑1.5 X 25CM			
内盒尺寸	12*9.5*6CM			
外箱尺寸	49.5*25.5*30.5CM			
输出电压	14.5±0.5V 35安培			
一箱只数	50			
铝壳尺寸				
重要说明				
产品编号	R2012C. 6		 <p>1. Ignition Switch / Sensor 2. Battery (+) / Bateria (+) 3. GND / Masa 4. Power Coil / Bobina de Carga 5. Power Coil / Bobina de Carga 6. Power Coil / Bobina de Carga</p>	Daelim X-Motion 125 Neu Original TGB TGB-552803
产品单重	220克			
检测程序	325 2056			
电线插头	25CM			
内盒尺寸	12*9.5*6CM			
外箱尺寸	49.5*25.5*30.5CM			
输出电压	14.5±0.5V 35安培			
一箱只数	50			
铝壳尺寸				
重要说明				
产品编号	R2012C. 7		 <p>1. GND / Masa 2. Battery (+) / Bateria (+) 3. Power Coil / Bobina de Carga 4. Power Coil / Bobina de Carga 5. Power Coil / Bobina de Carga</p>	31600-HJA-900 SYM MAXSYM TL 500 ABS hja 900
产品单重	净重362克			
检测程序	M325			
电线插头	25CM			
内盒尺寸	12*9.5*6CM			
外箱尺寸	49.5*25.5*30.5CM			
输出电压	14.5±0.5V 35安培			
一箱只数	50			
铝壳尺寸				
重要说明				
产品编号	R2012D. 1		 <p>1. Battery (+) / Bateria (+) 2. GND / Masa 3. Power Coil / Bobina de Carga 4. Power Coil / Bobina de Carga 5. Power Coil / Bobina de Carga 6. Field Coil / Bobina de Campo (White/ Blanco) 7. Ignition Switch / Sensor (Black/ Negro) 8. GND / Masa (Green/ Verde)</p>	Honda CB350F CB400F CB500K CB550 CB750
产品单重	220克			
检测程序	CB750+励磁			
电线插头	25CM			
内盒尺寸	12*9.5*6CM			
外箱尺寸	49.5*25.5*30.5CM			
输出电压	14.5±0.5V			
一箱只数	50			
铝壳尺寸				
重要说明				

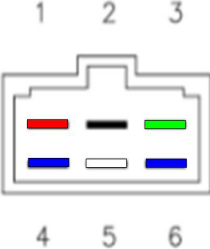



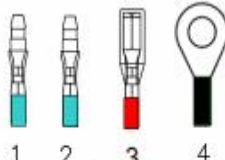
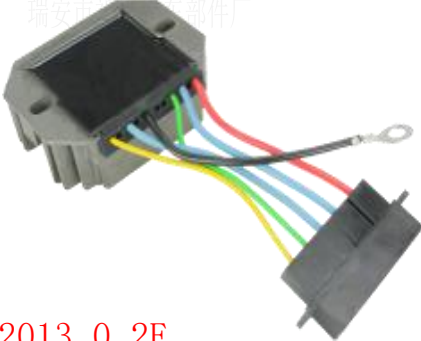
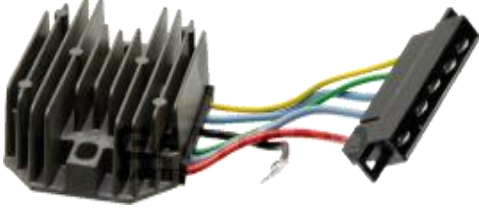
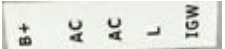

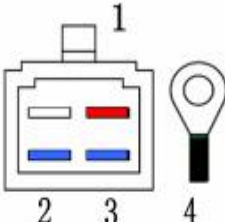
产品资料1		实物主图	接口图	适用范围
产品编号	R2012D. 2		 <p>1. GND / Masa 2. Battery (+) / Bateria (+) 3. Power Coil / Bobina de Carga 4. Power Coil / Bobina de Carga 5. Power Coil / Bobina de Carga 6. Power Coil / Bobina de Carga</p>	Honda NX Falcon 400 hasta 2014 31600-MCG-850 Reem lazo Shin ngen SH5326F
产品单重	220克			
检测程序	315			
电线插头	25CM			
内盒尺寸	12*9.5*6CM			
外箱尺寸	49.5*25.5*30.5CM			
输出电压	14.5±0.5V			
一箱只数	50			
铝壳尺寸				
重要说明				
产品编号	R2012D. 3		 <p>1. Ignition Switch / Sensor 2. Battery (+) / Bateria (+) 3. GND / Masa 4. Power Coil / Bobina de Carga 5. Power Coil / Bobina de Carga 6. Power Coil / Bobina de Carga</p>	2468 Arctic CatUtility250 2006 20093303-836 Arctic CatUtility300 2010 20163303-836 Arctic CatUtility150 2009 20193303-836 Can AmDS250 2006 2015S31600RCA000 KymcoMXU250 2004 200831600-LBA7-900 KymcoMXU300 2005 201131600-LBA7-900 KymcoMXU150 2005 201131600-LBA7-900
产品单重	220克			
检测程序	325 2468 2467			
电线插头	20 CM			
内盒尺寸	12*9.5*6CM			
外箱尺寸	49.5*25.5*30.5CM			
输出电压	14.5±0.5V 35安培			
一箱只数	50			
铝壳尺寸				
重要说明				
产品编号	R2012D. 4			VOLTAGE REGULATOR KYMCO SCOOTER E0 LE S 250 2005, 2006, 2007, KYMCO 31600-LDH1-E00
产品单重	220克			
检测程序	325			
电线插头	10 20CM			
内盒尺寸	12*9.5*6CM			
外箱尺寸	49.5*25.5*30.5CM			
输出电压	14.5±0.5V			
一箱只数	50			
铝壳尺寸				
重要说明				
产品编号	R2012D. 5		 <p>1. Battery (+) / Bateria (+) 2. GND / Masa 3. Power Coil / Bobina de Carga 4. Power Coil / Bobina de Carga 5. Power Coil / Bobina de Carga</p>	2599 M325 Kymco Dink IE Euro 3 200 de 2008 a 2013 31600-KED9-910 Kymco Downtown i 200 de 2010 a 2013 31600-KED9-910 Kymco Downtown i 300 de 2009 a 2013 31600-KED9-910 Kymco Downtown i 125 de 2009 a 2013 31600-KED9-910 Kymco eo le S IE 300 de 2008 a 2012 31600-KED9-910
产品单重	220克			
检测程序	325 2599			
电线插头	20CM			
内盒尺寸	12*9.5*6CM			
外箱尺寸	49.5*25.5*30.5CM			
输出电压	14.5±0.5V			
一箱只数	50			
铝壳尺寸				
重要说明				

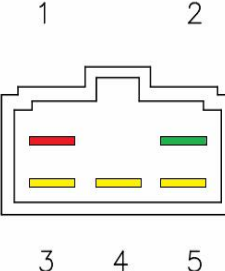

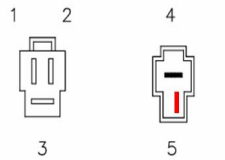
产品资料1		实物主图	接口图	适用范围
产品编号	2012D.6		 <ol style="list-style-type: none"> 1. Power Coil 2. Ignition Switch 3. GND 4. Battery (+) 5. Power Coil 	光阳整流器
产品单重	220克			
检测程序	215			
电线插头	20CM			
内盒尺寸	12*9.5*6CM			
外箱尺寸	49.5*25.5*30.5CM			
输出电压	14.5±0.5V			
一箱只数	50			
铝壳尺寸				
重要说明				
产品编号	2012D.7		 <ol style="list-style-type: none"> 1. Power Coil / Bobina de Carga 2. Ignition Switch / Sensor 3. GND / Masa 4. Battery (+) / Bateria (+) 5. Power Coil / Bobina de Carga 	31600-M9Q-000 Sym Jet basix 50 Sym Euro MX 125 2002-2005 SYM Euro MX 150 2002-2005 Sym Jet 50 Euro X 2003-2007 Sym Jet Euro X 50 2003-2012 Sym Jet ijl 50 2006 Sym Jet 5 125 2010-2012 Sym Jet 50 E2 2003-2012 Sym Jet V 125 2010-2012 Sym Metro Euro a 125
产品单重	220克			
检测程序	215			
电线插头	20CM			
内盒尺寸	12*9.5*6CM			
外箱尺寸	49.5*25.5*30.5CM			
输出电压	14.5±0.5V			
一箱只数	50			
铝壳尺寸				
重要说明				
产品编号	2012D.8		 <ol style="list-style-type: none"> 1. Ignition Switch / Sensor 2. Battery (+) / Bateria (+) 3. GND / Masa 4. Power Coil / Bobina de Carga 5. Power Coil / Bobina de Carga 6. Power Coil / Bobina de Carga 	Daelim X-Motion 125 Neu Original TGB TGB-552803
产品单重	净重 215克			
检测程序	215			
电线插头	20CM			
内盒尺寸	12*9.5*6CM			
外箱尺寸	49.5*25.5*30.5CM			
输出电压	14.5±0.5V			
一箱只数	50			
铝壳尺寸				
重要说明				
产品编号	R2013A.0		 <ol style="list-style-type: none"> 1. Battery (+) / Bateria (+) 2. Ignition Switch / Sensor 3. GND / Masa 4. Power Coil / Bobina de Carga 5. Charge Lamp/ Lámpara Piloto 6. Power Coil / Bobina de Carga 	OEM: M97348 AM70121 AM126304 21066-2056 21066-2070 JJOHN DEERE 130 15A M70121 JOHN DEERE 160 15A M70121 JOHN DEERE 165 15A M70121 JOHN DEERE 170 15A M70121 JOHN DEERE 172 15A M70121 JOHN DEERE 175 15A M70121 JOHN DEERE 176 15A M70121 JOHN DEERE 180 15A M70121 JOHN DEERE 185 15A M70121
产品单重	250克			
检测程序	QF2101新 2317 2316			
电线插头				
内盒尺寸	12*9.5*6CM			
外箱尺寸	49.5*25.5*30.5CM			
输出电压	14.5±0.5V 20安培			
一箱只数	50			
铝壳尺寸				
重要说明	6针插头			

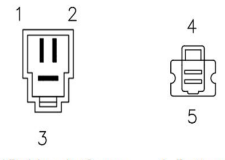

产品资料1		实物主图	接口图	适用范围
产品编号	R2013A.1		 <ol style="list-style-type: none"> 1. Battery (+) / Bateria (+) 2. Ignition Switch / Sensor 3. GND / Masa 4. Power Coil / Bobina de Carga 5. Charge Lamp / Lámpara Piloto 6. Power Coil / Bobina de Carga 	OEM: M97348 AM70121 AM126304 / 21066-2056 / 21066-2070 JJOHN DEERE 130 15A M70121 JOHN DEERE 160 15A M70121 JOHN DEERE 165 15A M70121 JOHN DEERE 170 15A M70121 JOHN DEERE 172 15A M70121 JOHN DEERE 175 15A M70121 JOHN DEERE 176 15A M70121 JOHN DEERE 180 15A M70121 JOHN DEERE 185 15A M70121
产品单重	净重200 克			
检测程序	QF2101新 2317 2316			
电线插头	6针插头			
内盒尺寸	12*9.5*6CM			
外箱尺寸	49.5*25.5*30.5CM			
输出电压	14.5±0.5V 20安培			
一箱只数	50			
铝壳尺寸				
重要说明	6针插头			
产品编号	R2013A.2		 <ol style="list-style-type: none"> 1. Battery (+) / Bateria (+) 2. Ignition Switch / Sensor 3. GND / Masa 4. Power Coil / Bobina de Carga 5. Power Coil / Bobina de Carga 	Honda 31600-890-951, 31600890951, 31600ZE2861, 31600-ZE2-861 SH586B-12
产品单重	净重200 克			
检测程序	215 2317 2316			
电线插头	5针插头			
内盒尺寸	12*9.5*6CM			
外箱尺寸	49.5*25.5*30.5CM			
输出电压	14.5±0.5V 20安培			
一箱只数	50			
铝壳尺寸				
重要说明	5针插头			
产品编号	R2013.0		 <ol style="list-style-type: none"> 1. Battery (+) 2. GND 3. Power Coil 4. Power Coil 5. Power Coil 	Suzuki AN250 AN400 SV650 32800-14F01-000 suzuki Burgman250/400 suzuki Skywave250/400 suzuki GS500/ GSF250/ GSF400 /GS850 suzuki 79A 7BA 7A suzuki GSF400 Bandit Suzuki GSXR400 GK76 GSXR 400 32800-33400, 32800-00A00, 32800-04A00
产品单重	210克			
检测程序	315			
电线插头	20CM			
内盒尺寸	12*9.5*6CM			
外箱尺寸	49.5*25.5*30.5CM			
输出电压	14.5±0.5V			
一箱只数	50			
铝壳尺寸				
重要说明				
产品编号	R2013.0.2		 <ol style="list-style-type: none"> 1. Power Coil 2. GND 3. Power Coil 4. Charge Lamp 5. Ignition Switch 6. Battery (+) 	Grassho er 1822D 185530 Grassho er 718D 185530 Grassho er 721D 185530 Grassho er 721G 185530 JOHN DEERE Tractor 750 M802471 JOHN DEERE Tractor 650 M802471 MIA881277 CH15589 Kubota 821G RS 5101 RS5101 RS5102 RS5104 RS5155 15351-64600 15351-64601 RP201-53710 KUBOTA GH5530 TRANSP0
产品单重	220克			
检测程序	QF2101			
电线长度	12CM			
内盒尺寸	12*9.5*6CM			
外箱尺寸	49.5*25.5*30.5CM			
输出电压	14.5±0.5V 20安培			
一箱只数	50			
铝壳尺寸				
重要说明	电线1平方粗, 颜色和图片一样			

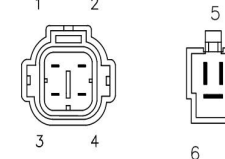
产品资料1		实物主图	接口图	适用范围
产品编号	R2013.0.2X	 <p>R2013.0.2X</p>	 <p>1. Power Coil 2. GND 3. Power Coil 4. Charge Lamp 5. Ignition Switch 6. Battery (+)</p> <p>R2013.0.2X</p>	18270169-A 19267-64600 19267-64600-A 19267-64601 19267-64601-A R 201- 53710 15531-64603 15531-64603-A 18270169 B2710HSD B2910HSD B7300HSD B7500DTN B7800HSD Kubota 久保田整流器
产品单重	200克盒重			
检测程序	QF2101 新 2328			
电线插头	12CM			
内盒尺寸	12*9.5*6CM			
外箱尺寸	49.5*25.5*30.5CM			
输出电压	14.5±0.5V 20安培			
一箱只数	50			
铝壳尺寸				
重要说明				
产品编号	R2013.0.2A	 <p>R2013.0.2A</p>	 <p>1. Battery (+) 2. Ignition Switch 3. GND 4. Power Coil 5. Charge Lamp 6. Power Coil</p> <p>R2013.0.2A</p>	OEM: M97348 AM70121 AM126304 / 21066- 2056 / 21066-2070 JJOHN DEERE 130 15A M70121 JOHN DEERE 160 15A M70121 JOHN DEERE 165 15A M70121 JOHN DEERE 170 15A M70121 JOHN DEERE 172 15A M70121 JOHN DEERE 175 15A M70121 JOHN DEERE 176 15A M70121 JOHN DEERE 180 15A M70121 JOHN DEERE 185 15A M70121
产品单重	220克			
检测程序	QF2101 新 2317 2316			
电线插头	12CM			
内盒尺寸	12*9.5*6CM			
外箱尺寸	49.5*25.5*30.5CM			
输出电压	14.5±0.5V 20安培			
一箱只数	50			
铝壳尺寸				
重要说明				
产品编号	R2013.0.2B	 <p>R2013.0.2B</p>	 <p>1. Power Coil / Bobina de Carga 2. GND / Masa 3. Power Coil / Bobina de Carga 4. Charge Lamp / Lámpara Piloto 5. Ignition Switch / Sensor 6. Battery (+) / Bateria (+) 7. GND / Masa</p> <p>R2013.0.2B</p>	Voltage Regulator that fits Kubota Tractor Models: B5200, B6200, B7200, B8200, B9200 Kubota 久保田整流器 洋马ATY3300柴油发电机充电模块 充电整 流器119660-77712调节器 Re laces art Number: EL 50-0019, H1550-64600, 15533-64600, 76611-55440
产品单重	净重204克 盒重206克			
检测程序	QF2101 新			
电线插头	12CM			
内盒尺寸	12*9.5*6CM			
外箱尺寸	49.5*25.5*30.5CM			
输出电压	14.5±0.5V			
一箱只数	50			
铝壳尺寸				
重要说明				
产品编号	R2013.0.2C	 <p>R2013.0.2C</p>	 <p>YELLOW WIRE 1. Power Coil / Bobina de Carga 2. GND / Masa 3. Power Coil / Bobina de Carga 4. Charge Lamp / Lámpara Piloto 5. Ignition Switch / Sensor 6. Battery (+) / Bateria (+) 7. GND / Masa</p> <p>R2013.0.2C</p>	119640-77710 119640-77711 RS5121 Regler Gleichrichter für TAKEUCHI KOMATSU YANMAR 119640-77710 12V NEU Laderegler 日本久保田KUBOTA发动机发电机冲电整流 器模块原厂配件Z482 D722 CUMMINS 康明斯
产品单重	净重200克 盒重226克			
检测程序	QF2101 新			
电线插头	12CM			
内盒尺寸	12*9.5*6CM			
外箱尺寸	49.5*25.5*30.5CM			
输出电压	14.5±0.5V			
一箱只数	50			
铝壳尺寸				
重要说明	14V 14.2V 18A 250W 安装孔59.7			

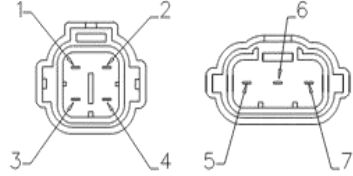

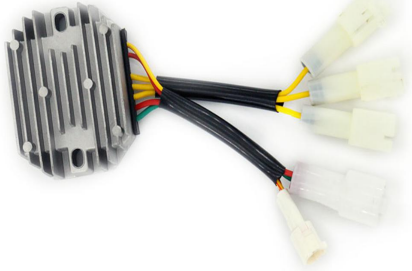
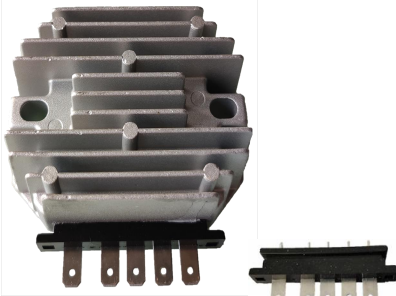
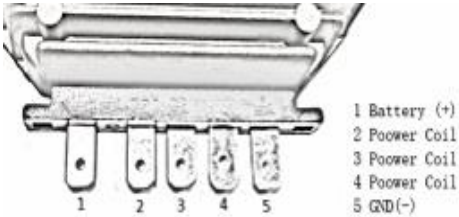

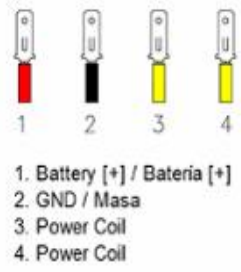
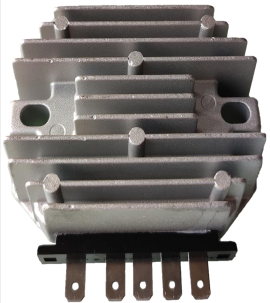
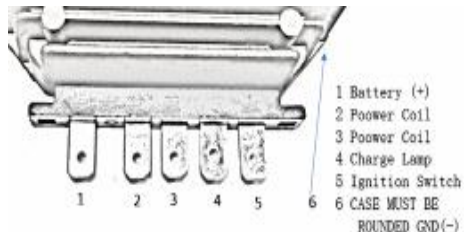
产品资料1		实物主图	接口图	适用范围
产品编号	R2013.0.2D		 <p>1 2 3 4</p> <p>1. Power Coil / Bobina de Carga 2. Power Coil / Bobina de Carga 3. Battery (+) / Bateria (+) 4. GND/ Masa</p>	Regulator Kubota Mo ls: B7100D B7100HST-D B7100HSTE 15372-64602 Kubota Tractor B4200 B5100E Kubota 66611- 55250 67211-55230 rs1104 j5000
产品单重	净重200克 盒重226克			
检测程序	168F			
电线插头	12CM			
内盒尺寸	12*9.5*6CM			
外箱尺寸	49.5*25.5*30.5CM			
输出电压	14.5±0.5V			
一箱只数	50			
铝壳尺寸				
重要说明				
产品编号	R2013.0.2E			MIA881279 AM101406 JOHN DEERE 332 JOHN DEERE: 1070, 2243, 415, 670, 770, 790, 870, 970, 990, F912, F915 洋马 YANMAR 
产品单重	净重 200克			
检测程序	QF2101 新			
电线插头	12CM			
内盒尺寸	12*9.5*6CM			
外箱尺寸	49.5*25.5*30.5CM			
输出电压	14.5±0.5V			
一箱只数	50			
铝壳尺寸				
重要说明				
产品编号	R2013.0.2F		 <p>1. Battery(+) 2. Power Coil (AC) 3. Power Coil (AC) 4. GND(-)</p>	Massey Ferguson RS5107 205-4 J5025 
产品单重	净重190克			
检测程序	168F			
电线插头	12CM			
内盒尺寸	12*9.5*6CM			
外箱尺寸	49.5*25.5*30.5CM			
输出电压	14.5±0.5V			
一箱只数	50			
铝壳尺寸				
重要说明	安装孔距63			
产品编号	R2013.0.3		 <p>1. Battery (+) 2. GND 3. Power Coil 4. Power Coil 5. Power Coil</p>	SUZUKISV650SV-650SV650S1999-2002
产品单重	220克			
检测程序	315			
电线插头	20CM			
内盒尺寸	12*9.5*6CM			
外箱尺寸	49.5*25.5*30.5CM			
输出电压	14.5±0.5V			
一箱只数	50			
铝壳尺寸				
重要说明				

产品资料1		实物主图	接口图	适用范围
产品编号	R2013.1		 <p>1. Power Coil / Bobina de Carga 2. Power Coil / Bobina de Carga 3. Power Coil / Bobina de Carga 4. GND / Masa 5. Battery (+) / Batería (+)</p>	2408 20A Reem lazo Shin ngen SH572MB Suzuki AN 125 2000 32800-22D11 Suzuki AN Burgman 250 1996 2000 32800-22D10 Suzuki AN Burgman 125 1995 2000 32800-22D10 Suzuki EN 125 2004 2008 32800-22D20 Suzuki EN A2 125 32800-37G10-000 Suzuki GN 125 32800-37G10-000 Suzuki GSX 250 1991 1997 32800-
产品单重	210克			
检测程序	315 2396 2408			
电线插头	25CM			
内盒尺寸	12*9.5*6CM			
外箱尺寸	49.5*25.5*30.5CM			
输出电压	14.5±0.5V 25安培			
一箱只数	50			
铝壳尺寸				
重要说明	3黑线交流1黑红正1黑白负			
产品编号	R2013.1.1		 <p>1. Power Coil / Bobina de Carga 2. Power Coil / Bobina de Carga 3. Power Coil / Bobina de Carga 4. Battery (+) / Batería (+) 5. GND / Masa</p>	SUZUK DR650S 1990-1991 胡思瓦纳 Husqvarna TC250R TC250
产品单重	210克			
检测程序	315			
电线插头	25CM			
内盒尺寸	12*9.5*6CM			
外箱尺寸	49.5*25.5*30.5CM			
输出电压	14.5±0.5V			
一箱只数	50			
铝壳尺寸				
重要说明				
产品编号	R2013.1.2		 <p>绿白线 12V5W 转向灯负极 黑白线 12V5W 大灯正极</p>	BAJAJ 175 205 (三轮车整流器)
产品单重	220克			
检测程序	315			
电线插头	20CM			
内盒尺寸	12*9.5*6CM			
外箱尺寸	49.5*25.5*30.5CM			
输出电压	14.5±0.5V			
一箱只数	50			
铝壳尺寸				
重要说明				
产品编号	R2013.1.4		 <p>1. Battery (+) / Batería (+) 2. Battery (+) / Batería (+) 3. GND / Masa 4. GND / Masa 5. Power Coil / Bobina de Carga 6. Power Coil / Bobina de Carga 7. Power Coil / Bobina de Carga</p>	2455 Arctic Cat - 3530-028 Arctic Cat ATV AUTO 4x4 400 2003 3402-682 Arctic Cat ATV AUTO 4x4 400 2004 2005 3402-682 Arctic Cat ATV TBX AUTO 4x4 400 2006 3402-682 Arctic Cat ATV V AUTO 4x4 400 2005 2006 3402-682 Arctic Cat ATV FIS AUTO 2x4 / 4x4 400
产品单重	克			
检测程序	M325			
电线插头	25 CM			
内盒尺寸	12*9.5*6CM			
外箱尺寸	49.5*25.5*30.5CM			
输出电压	14.5±0.5V			
一箱只数	50			
铝壳尺寸				
重要说明				

产品资料1		实物主图	接口图	适用范围
产品编号	R2013.1.5		 <p>1. Battery (+) / Bateria (+) 5. Power Coil / Generado 2. Battery (+) / Bateria (+) 6. Power Coil / Generado 3. Battery (-) / Bateria (-) 7. Power Coil / Generado 4. Battery (-) / Bateria (-)</p>	2541 PolarisOutlaw450 2008 20104012536 PolarisOutlaw500 2006 20074012536 PolarisOutlawS / IRS525 2007 2011 4012536 Polaris redator500 2003 2007 4010654
产品单重	210克			
检测程序	325 2454 2541			
电线插头	25CM			
内盒尺寸	12*9.5*6CM			
外箱尺寸	49.5*25.5*30.5CM			
输出电压	14.5±0.5V 35安培			
一箱只数	50			
铝壳尺寸				
重要说明				
产品编号	R2013.1.6		<p>R2013.1.6</p>	BAJAJ 225
产品单重	250克			
检测程序	315			
电线插头	20CM 电容线40CM			
内盒尺寸	12*9.5*6CM			
外箱尺寸	49.5*25.5*30.5CM			
输出电压	14.5±0.5V			
一箱只数	50			
铝壳尺寸				
重要说明				
产品编号	R2013.1.7		 <p>R2013.1.7</p>	BAJAJ
产品单重	250克			
检测程序	315			
电线插头	20CM 电容线40CM			
内盒尺寸	12*9.5*6CM			
外箱尺寸	49.5*25.5*30.5CM			
输出电压	14.5±0.5V			
一箱只数	50			
铝壳尺寸				
重要说明				
产品编号	R2013.2		 <p>1 Battery (+) 2 Power Coil 3 Power Coil 4 Power Coil 5 GND(-)</p> <p>R2013.2</p>	SUZUKI GS1150ES3 1984-1986 GS1150ESE 1984-1986 GS1150ESF 1984-1986 GS1150ESG 1984-1986 SUZUKI GS300 GS400 GS450 GR650 GS750 GS1150 32800- 33400, 32800-00A00, 32800-04A00 REGULATOR RECTIFIER Fits SUZUKI XN85- D GS850G 1982 1983
产品单重	210克			
检测程序	315			
电线插头				
内盒尺寸				
外箱尺寸	49.5*25.5*30.5CM			
输出电压	14.5±0.5V			
一箱只数	50			
铝壳尺寸				
重要说明				

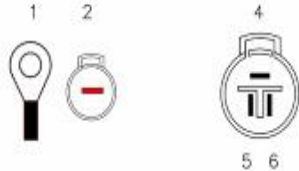

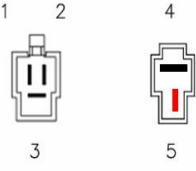

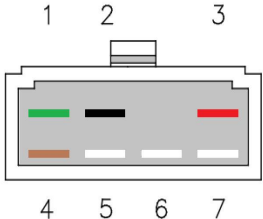
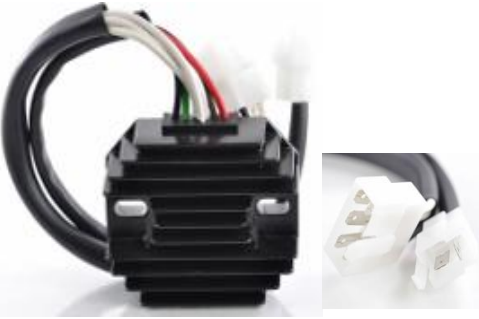
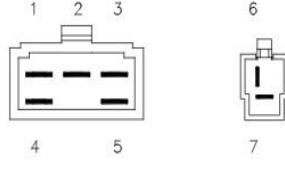

产品资料1		实物主图	接口图	适用范围
产品编号	R2013. 2F		 <p>负极 AC AC AC 正极 - AC AC AC +</p>	上海代购定做的
产品单重	210克			
检测程序	315			
电线插头				
内盒尺寸				
外箱尺寸	49.5*25.5*30.5CM			
输出电压	14.5±0.5V			
一箱只数	50			
铝壳尺寸				
重要说明				
产品编号	R2013. 2. 1		 <p>1 2 3 4</p> <p>1. Battery [+]/ Bateria [+] 2. GND / Masa 3. Power Coil 4. Power Coil</p>	SUZUKI GS1150ES3 1984-1986 GS1150ESE 1984-1986 GS1150ESF 1984-1986 GS1150ESG 1984-1986 SUZUKI GS300 GS400 GS450 GR650 GS750 GS1150 32800-33400, 32800-00A00, 32800-04A00
产品单重	210克			
检测程序	215			
电线插头				
内盒尺寸	12*9.5*6CM			
外箱尺寸	49.5*25.5*30.5CM			
输出电压	14.5±0.5V			
一箱只数	50			
铝壳尺寸				
重要说明				
产品编号	R2013. 2. 2		 <p>1 Battery (+) 2 Power Coil 3 Power Coil 4 Charge Lamp 5 Ignition Switch 6 CASE MUST BE ROUNDED GND(-)</p>	YANMAR TRACTOR 129150-77710, AM101406M, MIA881279
产品单重	210克			
检测程序	QF2101 新			
电线插头				
内盒尺寸	12*9.5*6CM			
外箱尺寸	49.5*25.5*30.5CM			
输出电压	14.5±0.5V			
一箱只数	50			
铝壳尺寸				
重要说明				
产品编号	R2013. 3			OEM=4012263 北极星M121265-162-S I-A 2009 Polaris 600 IQ Shift 136 RMK Shift 144 155 2010 2011 Polaris 600 ro-Ri Rush Wi trak IQ Rush ES LX Retro ro-R Retro ES 2010 Polaris 600 Wi trak IQ 2011 Polaris 800 ro RMK 155 163 2011 Polaris 800 RMK 155 ES 2011 Polaris 800 RMK Assault 155 2011 Polaris 800 Rush
产品单重	210克			
检测程序	215			
电线插头	细线15 1 平方线20CM			
内盒尺寸	12*9.5*6CM			
外箱尺寸	49.5*25.5*30.5CM			
输出电压	14.5±0.5V			
一箱只数	50			
铝壳尺寸				
重要说明				



产品资料1		实物主图	接口图	适用范围
产品编号	R2013.6		 <p>1. Battery (+) / Bateria (+) 2. GND / Masa 3. Power Coil / Bobina de Carga 4. Power Coil / Bobina de Carga 5. Power Coil / Bobina de Carga</p>	2384 Cagiva Ra tor 650 2001 2005 Reem lazo ietcard 1184 Suzuki DR SE 350 1997 1999 32800-14D11 Suzuki DR SE 250 1990 1995 32800-14D10 Suzuki DR SE 350 1990 1996 32800-14D10 Suzuki LS Savage LS650 K1 K2 K3 650 1996 2004 32800-24B01
产品单重	210克			
检测程序	315			
电线插头	20CM			
内盒尺寸	12*9.5*6CM			
外箱尺寸	49.5*25.5*30.5CM			
输出电压	14.5±0.5V			
一箱只数	50			
铝壳尺寸				
重要说明				
产品编号	R2013.6L		 <p>1. Battery (+) / Bateria (+) 2. GND / Masa 3. Power Coil / Bobina de Carga 4. Power Coil / Bobina de Carga 5. Power Coil / Bobina de Carga</p>	龙华专用 Suzuki SV 650 32800-24B01
产品单重	210克			
检测程序	315			
电线插头	20CM			
内盒尺寸	12*9.5*6CM			
外箱尺寸	49.5*25.5*30.5CM			
输出电压	14.5±0.5V			
一箱只数	50			
铝壳尺寸				
重要说明	和2013.6红线位置 不一样			
产品编号	R2013.7		 <p>1. Power Coil / Bobina de Carga 2. Power Coil / Bobina de Carga 3. Power Coil / Bobina de Carga 4. GND / Masa 5. Battery (+) / Bateria (+)</p>	YHC073/SKU255845/ Application: Suzuki GSXR400 GK76A 1990-1995 Suzuki GS500 1989-2003 Suzuki GS500E 1989-2000 Suzuki DR650S 1990-1991
产品单重	210克			
检测程序	315			
电线插头	25CM			
内盒尺寸	12*9.5*6CM			
外箱尺寸	49.5*25.5*30.5CM			
输出电压	14.5±0.5V			
一箱只数	50			
铝壳尺寸				
重要说明				
产品编号	R2013.8		 <p>1. Battery (+) / Bateria (+) 2. Power Coil / Bobina de Carga 3. GND / Masa 4. Power Coil / Bobina de Carga 5. Power Coil / Bobina de Carga 6. Power Coil / Bobina de Carga</p>	Yamaha Outboard 1998 50HP62Y-81960-00-00 (A16-2F) 船舷 整流器
产品单重	210克			
检测程序	315			
电线插头	20CM			
内盒尺寸	12*9.5*6CM			
外箱尺寸	49.5*25.5*30.5CM			
输出电压	14.5±0.5V			
一箱只数	50			
铝壳尺寸				
重要说明	3插的 默认是黑色插头			

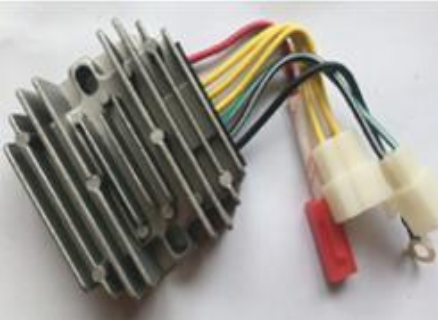

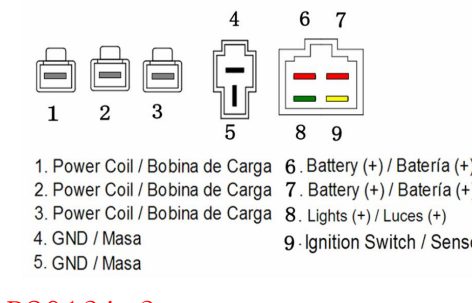

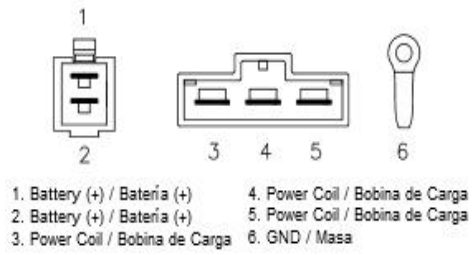

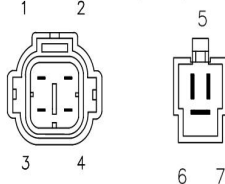
产品资料1		实物主图	接口图	适用范围
产品编号	R2013.9		 <p>1. GND / Masa 2. Battery (+) / Batería (+) 4. Power Coil / Bobina de Carga 5. Power Coil / Bobina de Carga 6. Power Coil / Bobina de Carga</p>	32800-87J00 船舷 整流器 JOHNSON OUTBOARD 50H RECTIFIER REGULATOR 5032615 5030795 Suzuki 32800-87J00 Suzuki 32800-87J10 Suzuki DF40 QHS/L; TS/L 1999-2004 Suzuki DF50 QHS/L; TS/L 1999-2004
产品单重	210克			
检测程序	325			
电线插头	2530CM			
内盒尺寸	12*9.5*6CM			
外箱尺寸	49.5*25.5*30.5CM			
输出电压	14.5±0.5V			
一箱只数	50			
铝壳尺寸				
重要说明				
产品编号	R2013.10		 <p>1. Power Coil / Bobina de Carga 2. Power Coil / Bobina de Carga 3. Power Coil / Bobina de Carga 4. GND / Masa 5. Battery (+) / Batería (+)</p>	SUZUKI SV 650
产品单重	210克			
检测程序	315			
电线插头	25 35 0CM			
内盒尺寸	12*9.5*6CM			
外箱尺寸	49.5*25.5*30.5CM			
输出电压	14.5±0.5V			
一箱只数	50			
铝壳尺寸				
重要说明				
产品编号	R2013.11		 <p>1. Field Coil 2. GND 3. Battery (+) 4. Ignition Switch 5. Power Coil 6. Power Coil 7. Power Coil</p>	Reemplazo Shindengen SH233-A12 Yamaha FJ 600 de 1984 a 1985 12R-81960-A1-00 Yamaha FZ 600 de 1986 a 1988 2XL-81960-A0-00 Yamaha XJ R Seca 650 de 1982 a 1983 4H7-81960-50 Yamaha XJ 600 de 1984 a 1986 12R-81960-A0-00 Yamaha XJ R Seca 900 de 1983 a 1984 12R-81960-A0-00
产品单重	210克			
检测程序	CB750+励磁 2481			
电线插头	25CM			
内盒尺寸	12*9.5*6CM			
外箱尺寸	49.5*25.5*30.5CM			
输出电压	14.5±0.5V			
一箱只数	50			
铝壳尺寸				
重要说明				
产品编号	R2013.12		 <p>1. Battery (+) / Batería (+) 2. Power Coil / Bobina de Carga 3. Power Coil / Bobina de Carga 4. GND / Masa 5. Power Coil / Bobina de Carga 6. Field Coil / Bobina de Campo 7. Ignition Switch / Sensor</p>	2331 25A Yamaha TX 650 1974 447-81970-10 & 1L9-81910-50 Yamaha TX 650 1973 256-81970-11 & 1L9-81910-50 Yamaha XS 400 1977 1978 1L9-81970-60 & 1L9-81910-50 Yamaha XS XS-1 650 1970 256-81970-11 & 1L9-81910-50 Yamaha XS XS-1B 650 1971 256-81970-11 & 1L9-81910-50
产品单重	210克			
检测程序	CB750+励磁 2331			
电线插头	35CM			
内盒尺寸	12*9.5*6CM			
外箱尺寸	49.5*25.5*30.5CM			
输出电压	14.5±0.5V 25安培			
一箱只数	50			
铝壳尺寸				
重要说明				

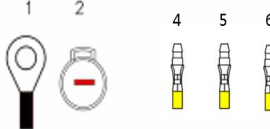
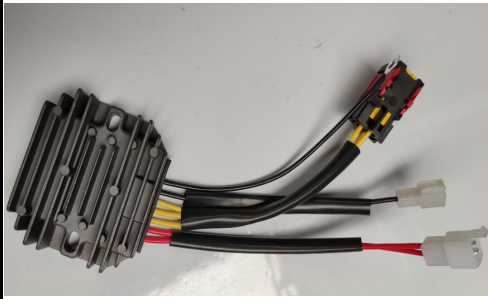

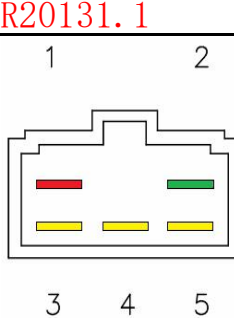

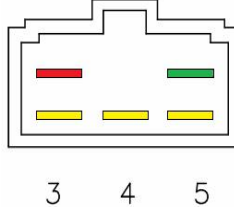

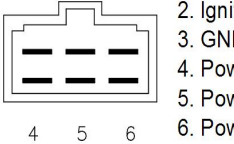
产品资料1		实物主图	接口图	适用范围
产品编号	R2013.13			Yamaha TX 650 1974 447-81970-10 & 1L9-81910-50 Yamaha TX 650 1973 256-81970-11 & 1L9-81910-50 Yamaha XS 400 1977 1978 1L9-81970-60 & 1L9-81910-50 Yamaha XS XS-1 650 1970 256-81970-11 & 1L9-81910-50 Yamaha XS XS-1B 650 1971 256-81970-11 & 1L9-81910-50 Yamaha XS XS-2 650 1972 256-81970-11
产品单重	210克			
检测程序	CB750+励磁			
电线插头	25CM			
内盒尺寸	12*9.5*6CM			
外箱尺寸	49.5*25.5*30.5CM			
输出电压	14.5±0.5V			
一箱只数	50			
铝壳尺寸				
重要说明				
产品编号	R2013.14			Regulator Rectifier 2540322 2540322-S Yamaha XS 360 1976 1977 1L9-81970-60 & 1L9-81910-50
产品单重	克			
检测程序				
电线插头	12M			
内盒尺寸	12*9.5*6CM			
外箱尺寸	49.5*25.5*30.5CM			
输出电压	14.5±0.5V			
一箱只数	50			
铝壳尺寸				
重要说明				
产品编号	R2013.15			898103T14 Mercury 25 30 H 4-Stroke 3 Cyl 853811T10
产品单重	克			
检测程序	M325 50安培			
电线插头	10 15 25CM			
内盒尺寸	12*9.5*6CM			
外箱尺寸	49.5*25.5*30.5CM			
输出电压	14.5±0.5V			
一箱只数	50			
铝壳尺寸				
重要说明				
产品编号	R2013.16		 <p>1. GND / Masa 2. Battery (+) / Bateria (+) 4. Power Coil / Bobina de Carga 5. Power Coil / Bobina de Carga 6. Power Coil / Bobina de Carga</p>	Tohatsu 25 30 40 50 70 75 90 H 2002-2010 东发 (TOHATSU) GG3E22509 Tohatsu 50 H Rectifier Regulator Assembly N 3T5760600 Fits 2002-2010
产品单重	净重210克			
检测程序	M325			
电线插头	15 CM			
内盒尺寸	12*9.5*6CM			
外箱尺寸	49.5*25.5*30.5CM			
输出电压	14.5±0.5V			
一箱只数	50			
铝壳尺寸				
重要说明				

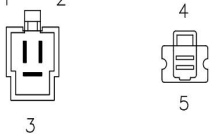

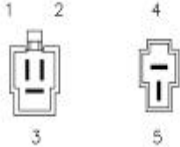

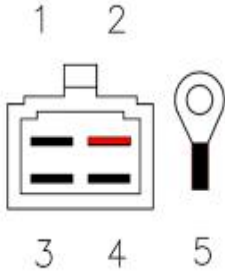

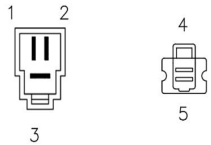
产品资料1		实物主图	接口图	适用范围
产品编号	R2013.17		<p>1. Power Coil 2. Power Coil 3. Power Coil</p> <p>4. GND 5. Battery (+)</p>	KTM 400 EGS-E 1997 KTM 400 LSE 1997 KTM 400 RXC-E 1997-98 KTM 400 LC4 1998-2001 KTM 400 LC4 EXC 2000-2001 KTM 400 RXC 1998 KTM 450 Rally 2005 KTM 620 DUKE 1996- KTM 620 DUKE-E 1997 KTM 620 EGS-E 1997 KTM 620 ENDURO LIMITED 1997
产品单重	克			
检测程序	M325			
电线插头	20 45CM			
内盒尺寸	12*9.5*6CM			
外箱尺寸	49.5*25.5*30.5CM			
输出电压	14.5±0.5V			
一箱只数	50			
铝壳尺寸				
重要说明				
产品编号	R2013.18		<p>1. Battery (+) / Bateria (+) 2. GND / Masa</p> <p>5. Power Coil / Bobina de Carga 6. Power Coil / Bobina de Carga 7. Power Coil / Bobina de Carga</p>	KTM XC SX 450 505 525 2008 2009
产品单重	净重 260克			
检测程序	M325			
电线插头	35 CM			
内盒尺寸	12*9.5*6CM			
外箱尺寸	49.5*25.5*30.5CM			
输出电压	14.5±0.5V			
一箱只数	50			
铝壳尺寸				
重要说明				
产品编号	R2013.19		<p>1. GND / Masa 2. Battery (+) / Bateria (+)</p> <p>4. Power Coil / Bobina de Carga 5. Power Coil / Bobina de Carga 6. Power Coil / Bobina de Carga</p>	Suzuki DF 200 225 250 32800-93J03
产品单重	净重 225克			
检测程序	M325			
电线插头	15 25 40 CM			
内盒尺寸	12*9.5*6CM			
外箱尺寸	49.5*25.5*30.5CM			
输出电压	14.5±0.5V			
一箱只数	50			
铝壳尺寸				
重要说明				
产品编号	R2013.20			Tohatsu 15HP 20HP Tohatsu MFS15C MFS20C MFS15D MFS20D Buitenboordmotor 3BJ-76060-0 3BJ-76060-1
产品单重	净重210克			
检测程序	M325-1			
电线插头	其他线25CM 白色线40CM			
内盒尺寸	12*9.5*6CM			
外箱尺寸	49.5*25.5*30.5CM			
输出电压	14.5±0.5V			
一箱只数	50			
铝壳尺寸				
重要说明				

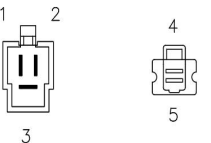

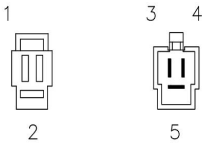

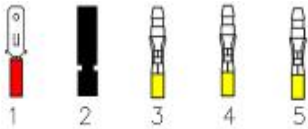

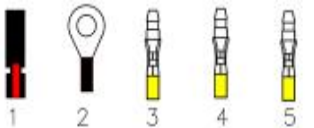
产品资料1		实物主图	接口图	适用范围
产品编号	R2013. 21			Tohatsu 15HP 20HP Tohatsu MFS15C MFS20C MFS15D MFS20D Buitenboordmotor 3BJ-76060-0 3BJ-76060-1
产品单重	净重210克			
检测程序	M325-1			
电线插头	40CM			
内盒尺寸	12*9.5*6CM			
外箱尺寸	49.5*25.5*30.5CM			
输出电压	14.5±0.5V			
一箱只数	50			
铝壳尺寸				
重要说明				
产品编号	R2013A. 2			BAJAJ 175 205
产品单重				
检测程序	315			
电线插头	25CM			
内盒尺寸	12*9.5*6CM			
外箱尺寸	49.5*25.5*30.5CM			
输出电压	14.5±0.5V			
一箱只数	50			
铝壳尺寸				
重要说明				
产品编号	R2013A. 3			19000-77711 11900077711 119000-77713 11900077713 Yanmar 3TNE84 Motor 洋马YANMAR AM877958, MIA881692 All JOHN DEERE Tractors - Utility 2210 Yanmar 23HP Dsl All JOHN DEERE Tractors - Utility 2305 Yanmar 24.1HP Dsl All JOHN DEERE Tractors - Utility 2320 Yanmar 24.1HP Dsl All JOHN DEERE Tractors - Utility
产品单重				
检测程序				
电线插头	12CM			
内盒尺寸	12*9.5*6CM			
外箱尺寸	49.5*25.5*30.5CM			
输出电压	14.5±0.5V 35安培			
一箱只数	50			
铝壳尺寸				
重要说明				
产品编号	R2013A. 4			KTM Duke 125 2017 2019 93011034000 KTM Duke 250 2017 2019 93011034000 KTM Duke 390 2017 2019 93011034000
产品单重	克			
检测程序	M325 50安培			
电线插头	15 25CM			
内盒尺寸	12*9.5*6CM			
外箱尺寸	49.5*25.5*30.5CM			
输出电压	14.5±0.5V			
一箱只数	50			
铝壳尺寸				
重要说明				

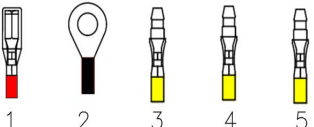

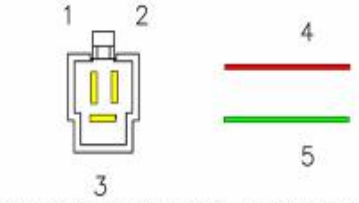

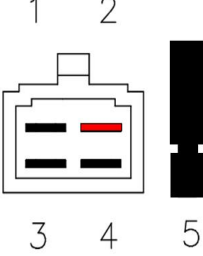
产品资料1		实物主图	接口图	适用范围
产品编号	R2013A.5		 <p>1. Battery (+) / Batería (+) 2. Battery (+) / Batería (+) 3. Power Coil / Bobina de Carga 4. Power Coil / Bobina de Carga 5. Power Coil / Bobina de Carga 6. GND / Masa</p>	KTM Duke 125 2017 2019 93011034000 KTM Duke 250 2017 2019 93011034000 KTM Duke 390 2017 2019 93011034000
产品单重	克			
检测程序	M325 50安培			
电线插头	20CM			
内盒尺寸	12*9.5*6CM			
外箱尺寸	49.5*25.5*30.5CM			
输出电压	14.5±0.5V			
一箱只数	50			
铝壳尺寸				
重要说明				
产品编号	R2013B.2		 <p>1. Battery (+) / Batería (+) 2. Battery (+) / Batería (+) 3. GND / Masa 4. GND / Masa 5. Power Coil / Bobina de Carga 6. Power Coil / Bobina de Carga 7. Power Coil / Bobina de Carga</p>	Suzuki VZ 800 VL 800
产品单重				
检测程序	M325			
电线插头	20CM			
内盒尺寸	12*9.5*6CM			
外箱尺寸	49.5*25.5*30.5CM			
输出电压	14.5±0.5V			
一箱只数	50			
铝壳尺寸				
重要说明				
产品编号	R2013B.3		 <p>1. GND / Masa 2. Battery (+) / Batería (+) 4. Power Coil / Bobina de Carga 5. Power Coil / Bobina de Carga 6. Power Coil / Bobina de Carga</p>	FN1T15004 Tohatsu Nissan 115 H Regulator Rectifier N 3C7760650 Fits 2002-2005
产品单重				
检测程序	M325			
电线插头	12CM			
内盒尺寸	12*9.5*6CM			
外箱尺寸	49.5*25.5*30.5CM			
输出电压	14.5±0.5V			
一箱只数	50			
铝壳尺寸				
重要说明				
产品编号	R2013B.4			587356/C ROYAL ENFIELD HIMALAYAN 400 2017 2019 Fits Royal Enfield Himalayan Regulator Rectifier 3 hase
产品单重	净重255克			
检测程序	M325 50安培			
电线插头	25CM			
内盒尺寸	12*9.5*6CM			
外箱尺寸	49.5*25.5*30.5CM			
输出电压	14.5±0.5V			
一箱只数	50			
铝壳尺寸				
重要说明				

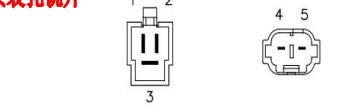

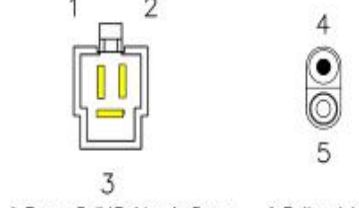

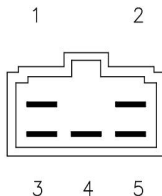

产品资料1		实物主图	接口图	适用范围
产品编号	R20131.1			洋马 Yanmar 119000-77711 119000-77713
产品单重	克			
检测程序				
电线插头	12CM			
内盒尺寸	12*9.5*6CM			
外箱尺寸	49.5*25.5*30.5CM			
输出电压	14.5±0.5V			
一箱只数	50			
铝壳尺寸				
重要说明				
产品编号	R2014.0		 <p>1. Battery (+) 2. GND 3. Power Coil 4. Power Coil 5. Power Coil</p>	2520 20A Benelli - R170077025000 Benelli Caffenero 125 s 2008 R050377025000 Benelli Caffenero 250 s 2008 R050377025000 Benelli Macis 250 s 2008 R050377025000 Benelli Macis 125 s 2008 R050377025000 Benelli Velvet 125 s 2008
产品单重	210克			
检测程序	325 2520 2469			
电线插头	5针插头			
内盒尺寸	12*9.5*6CM			
外箱尺寸	49.5*25.5*30.5CM			
输出电压	14.5±0.5V 20安培-35安培			
一箱只数	50			
铝壳尺寸				
重要说明	5针插头			
产品编号	R2014.1		 <p>1. Battery (+) / Bateria (+) 2. Ignition Switch / Sensor 3. GND / Masa 4. Power Coil / Bobina de Carga 5. Power Coil / Bobina de Carga 6. Power Coil / Bobina de Carga</p>	3DM-81960-00;SH661-12 Yamaha XV Virago 250 1996 2007 3DM-81960-00 Yamaha XV Virago 125 1997 1998 3DM-81960-00 Yamaha XV V-Star 250 2008 2015 3DM-81960-01 Yamaha XV 250 s 2016 3DM-81960-01
产品单重	210克			
检测程序	325			
电线插头	6针插头			
内盒尺寸	12*9.5*6CM			
外箱尺寸	49.5*25.5*30.5CM			
输出电压	14.5±0.5V			
一箱只数	50			
铝壳尺寸				
重要说明	6针插头			
产品编号	R2015.0		 <p>1. Power Coil / Bobina de Carga 2. Power Coil / Bobina de Carga 3. Power Coil / Bobina de Carga 4. Battery (+) / Bateria (+) 5. GND / Masa</p>	32800-29B-00; SH572A-12 SH572KA Arctic Cat 300 Quad 4x4 ATV ARCTIC CAT 300 1998至2003 THUN R 125STRTER+ENGKEL suzuki AN125 AN150 suzuki SV650 SV650S suzuki LS650 S40 Boulevard 2005-2009 2008 2007 suzuki GS1100 (E, G, GL, LT) Suzuki GN125 1982-2001 2000 Suzuki GZ125 1998-2011 GZ250 1999-
产品单重	盒重140克			
检测程序	308			
电线插头	15 CM			
内盒尺寸	12*9.5*6CM			
外箱尺寸	49.5*25.5*30.5CM			
输出电压	14.5±0.5V			
一箱只数	50			
铝壳尺寸				
重要说明				

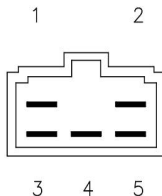
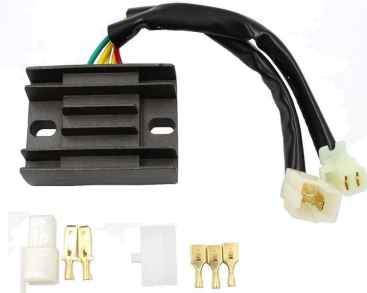
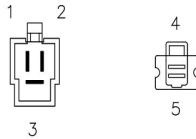

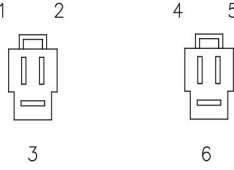

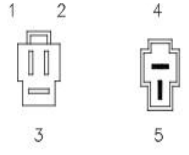

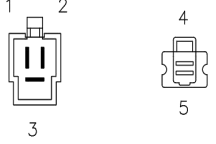
产品资料1		实物主图	接口图	适用范围
产品编号	R2015.0.1		 <p>1. Power Coil / Bobina de Carga 4. GND / Masa 2. Power Coil / Bobina de Carga 5. Battery (+) / Bateria (+) 3. Power Coil / Bobina de Carga</p>	suzuki AN125 AN150
产品单重	130克			
检测程序	308			
电线插头	20CM			
内盒尺寸	12*9.5*6CM			
外箱尺寸	49.5*25.5*30.5CM			
输出电压	14.5±0.5V			
一箱只数	50			
铝壳尺寸				
重要说明				
产品编号	R2015.1		 <p>1. Power Coil 2. Battery (+) 3. Power Coil 4. Power Coil 5. GND</p>	SUZUKI TU 250 XV (1997) GS 450 EE (1984-1985) SUZUKI GN250
产品单重	130克			
检测程序	308			
电线插头	25CM			
内盒尺寸	12*9.5*6CM			
外箱尺寸	49.5*25.5*30.5CM			
输出电压	14.5±0.5V			
一箱只数	50			
铝壳尺寸				
重要说明				
产品编号	R2015.2		 <p>1. Power Coil / Bobina de Carga 4. Battery (+) / Bateria (+) 2. Power Coil / Bobina de Carga 5. GND / Masa 3. Power Coil / Bobina de Carga</p>	32800-05300 32800-05320 32800-29B00 3530-014 Arctic Cat 250 2x4 1999-2003 Arctic Cat 300 2x4 1998-2001 Arctic Cat 300 4x4 1998-2001 Suzuki GN125 1982-1997 Suzuki GZ250 1999-2010 Arctic Cat 250 / 300 1998 1999 2000 2001 2003 THUN R 125STRTER+ENGKEL suzuki AN125 AN150
产品单重	130克			
检测程序	308			
电线插头	20CM			
内盒尺寸	12*9.5*6CM			
外箱尺寸	49.5*25.5*30.5CM			
输出电压	14.5±0.5V			
一箱只数	50			
铝壳尺寸				
重要说明	铝壳有缺口			
产品编号	R2015.2A		 <p>1. Power Coil / Bobina de Carga 4. Battery (+) / Bateria (+) 2. Power Coil / Bobina de Carga 5. GND / Masa 3. Power Coil / Bobina de Carga</p>	2435 Arctic CatATV4x4300 1998 2002 3530-014 Arctic CatATV4x4250 1999 20033530-014 Arctic CatATV2x4300 1998 20023530-014 Arctic CatATV2x4250 1999 20033530-014
产品单重	130克			
检测程序	308 2435			
电线插头	20CM			
内盒尺寸	12*9.5*6CM			
外箱尺寸	49.5*25.5*30.5CM			
输出电压	14.5±0.5V 20安培			
一箱只数	50			
铝壳尺寸				
重要说明	铝壳有缺口			

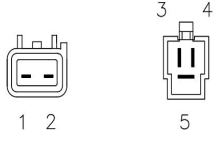



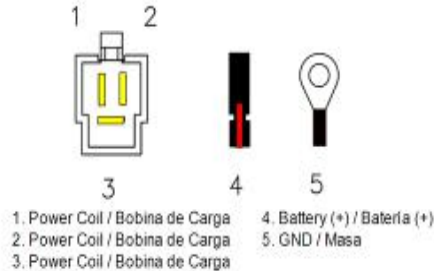

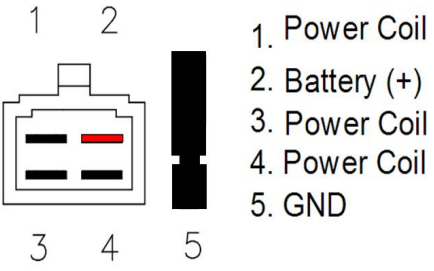
产品资料1		实物主图	接口图	适用范围
产品编号	R2015.2.1		 <p>1. Battery (+) / Bateria (+) 2. GND / Masa 3. Power Coil / Bobina de Carga 4. Power Coil / Bobina de Carga 5. Power Coil / Bobina de Carga</p>	32800-14F00 32800-24B00 32800-24B01 32800-24B10 32800-45C00 Suzuki LS650 Savage 1986-2004 Suzuki SV650 1999-2003 Suzuki SV650S 1999-2001 Suzuki VX800 1990-1993
产品单重	130克			
检测程序	308			
电线插头	20CM			
内盒尺寸	12*9.5*6CM			
外箱尺寸	49.5*25.5*30.5CM			
输出电压	14.5±0.5V			
一箱只数	50			
铝壳尺寸				
重要说明	铝壳有缺口			
产品编号	R2015.2.2		 <p>1. Battery (+) / Bateria (+) (Red/Rojo) 2. GND / Masa (Black/Negro) 3. Power Coil / Bobina de Carga (Yellow/Amarillo) 4. Power Coil / Bobina de Carga (Yellow/Amarillo) 5. Power Coil / Bobina de Carga (Yellow/Amarillo)</p>	Suzuki GS 450 G 1982 1983 1984 1985 1982 Suzuki GS1000S -- 1983 Suzuki GS1100ES -- 1984 Suzuki GS1100GK Tourer 1986 Suzuki GS1150EF -- 1985 Suzuki GS1150EF -- 1984 Suzuki GS1150EF -- 1985 Suzuki GS300L -- 1983 Suzuki GS300L -- 1982 Suzuki GS300L -- 1985 Suzuki GS450GA Suzukimatic
产品单重	130克			
检测程序	308			
电线插头	25CM			
内盒尺寸	12*9.5*6CM			
外箱尺寸	49.5*25.5*30.5CM			
输出电压	14.5±0.5V			
一箱只数	50			
铝壳尺寸				
重要说明	铝壳有缺口			
产品编号	R2015.2.3		 <p>1. Battery (+) / Bateria (+) (Red/Rojo) 2. GND / Masa (Black/Negro) 3. Power Coil / Bobina de Carga (Yellow/Amarillo) 4. Power Coil / Bobina de Carga (Yellow/Amarillo) 5. Power Coil / Bobina de Carga (Yellow/Amarillo)</p>	16440-45400 32500-45010 32500-45011 32500-45020 32500-45021 32800-43400 32800-44010 32800-44030 32800-44040 32800-44120 32800-44130 32800-45110 32800-45210 32800-45240 32800-47020 32800-47120 32800-49030 32800-49140 32800-49310 Volatge Regulator Rectifier Suzuki GS 550 E / L / T 1977 1978 1979 1980 1981 Suzuki GS1000 1978-1980
产品单重	130克			
检测程序	308			
电线插头	25CM			
内盒尺寸	12*9.5*6CM			
外箱尺寸	49.5*25.5*30.5CM			
输出电压	14.5±0.5V			
一箱只数	50			
铝壳尺寸				
重要说明	铝壳有缺口			
产品编号	R2015.2.3.1		 <p>1. Battery (+) / Bateria (+) (Red/Rojo) 2. GND / Masa (Black/Negro) 3. Power Coil / Bobina de Carga (Yellow/Amarillo) 4. Power Coil / Bobina de Carga (Yellow/Amarillo) 5. Power Coil / Bobina de Carga (Yellow/Amarillo)</p>	Suzuki GS425 1979-1979
产品单重	130克			
检测程序	308			
电线插头	20CM 黑线15CM			
内盒尺寸	12*9.5*6CM			
外箱尺寸	49.5*25.5*30.5CM			
输出电压	14.5±0.5V			
一箱只数	50			
铝壳尺寸				
重要说明	铝壳有缺口			

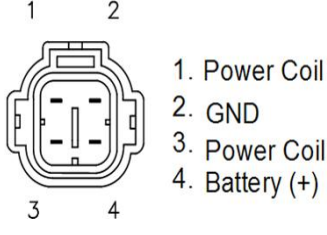
产品资料1		实物主图	接口图	适用范围
产品编号	R2015.2.4		 <p>1. Power Coil / Bobina de Carga 2. Power Coil / Bobina de Carga 3. Power Coil / Bobina de Carga</p> <p>4. Battery (+) / Bateria (+) 5. GND / Masa</p>	Kawasaki KLX 400 2003 2004 Suzuki DRZ400 -- 2003 Suzuki DRZ400 -- 2002 Suzuki DRZ400 -- 2001 Suzuki DRZ400 -- 2000 Suzuki DRZ400 -- 2007 Suzuki DRZ400E -- 2006 Suzuki DRZ400E -- 2005 Suzuki DRZ400E -- 2004 Suzuki DRZ400E -- 2003 Suzuki DRZ400E --
产品单重	130克			
检测程序	308			
电线插头	35CM			
内盒尺寸	12*9.5*6CM			
外箱尺寸	49.5*25.5*30.5CM			
输出电压	14.5±0.5V			
一箱只数	50			
铝壳尺寸				
重要说明	铝壳有缺口			
产品编号	R2015.2.5		 <p>1. Power Coil 2. Battery (+) 3. Power Coil 4. Power Coil 5. GND</p>	32800-09300 32800-24500 32800-43400 32800-44230 32800-45240 32800-47120 Suzuki LT 230 E Quadrunner 1987 Suzuki LT 230 G Quadrunner 1985-1993 Suzuki LT 300 E Quadrunner 1987-1989 Suzuki LTF 250 Quadrunner Manual 1988-1989 Suzuki GS1100E 1982-1983 Suzuki GS1100ES 1983 Suzuki GS1100G 1982-1983 Suzuki GS1100GL 1983
产品单重	130克			
检测程序	308			
电线插头	25CM			
内盒尺寸	12*9.5*6CM			
外箱尺寸	49.5*25.5*30.5CM			
输出电压	14.5±0.5V			
一箱只数	50			
铝壳尺寸				
重要说明	铝壳有缺口			
产品编号	R2015.2.6		安装孔铣开  <p>1. Power Coil / Bobina de Carga 2. Power Coil / Bobina de Carga 3. Power Coil / Bobina de Carga</p> <p>4. GND / Masa 5. Battery (+) / Bateria (+)</p>	2575 Arctic CatATV2x4 / 4x4250 2001 2005 3530-034 Arctic CatATV2x4 / 4x4300 2001 2005 3530-034 Reem lazoShin ngenSH572A-1 SuzukiLT-FKingQuad 4WD300 1999 2002 32800-29B10 SuzukiLT-FQuadRunner 4WD250 1999 200232800-29B10
产品单重	130克			
检测程序	308 2575			
电线插头	20CM			
内盒尺寸	12*9.5*6CM			
外箱尺寸	49.5*25.5*30.5CM			
输出电压	14.5±0.5V 20安培			
一箱只数	50			
铝壳尺寸				
重要说明	铝壳有缺口			
产品编号	R2015.2.7		 <p>1. Power Coil / Bobina de Carga 2. Power Coil / Bobina de Carga 3. Power Coil / Bobina de Carga</p> <p>4. Battery (+) / Bateria (+) 5. GND / Masa</p>	0530-006 Arctic Cat 400 2x4 2000 Arctic Cat 400 4x4 2000 Arctic Cat 500 4x4 Manual 2000-2001
产品单重	130克			
检测程序	308			
电线插头	25CM			
内盒尺寸	12*9.5*6CM			
外箱尺寸	49.5*25.5*30.5CM			
输出电压	14.5±0.5V			
一箱只数	50			
铝壳尺寸				
重要说明	铝壳有缺口			

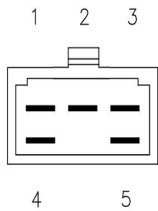

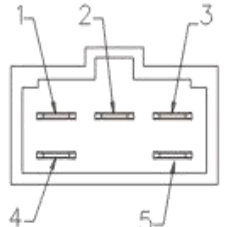

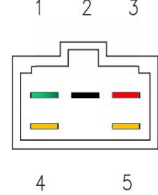

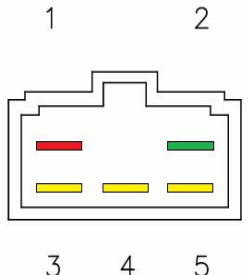
产品资料1		实物主图	接口图	适用范围
产品编号	R2015.2.9			SH572B-11 12V/CC-TRIFASE HONDA 125 XLR W (JD16A) 1998-2015
产品单重	130克			
检测程序	308			
电线插头	25CM			
内盒尺寸	12*9.5*6CM			
外箱尺寸	49.5*25.5*30.5CM			
输出电压	14.5±0.5V			
一箱只数	50			
铝壳尺寸				
重要说明				
产品编号	R2015.3		 <ol style="list-style-type: none"> 1. Battery (+) 2. GND 3. Power Coil 4. Power Coil 5. Power Coil 	Suzuki DR S 200 2015 2017 32800-19B11 Suzuki DR-Z 400 2009 32800-13E11 Suzuki DR-Z 250 2001 2007 32800-13E10 Suzuki LT QuadRunner 4WD 250 1987 1996 32800-19B10 Suzuki LT-F QuadRunner 4WD 250 1997 1998 32800-19B00 Suzuki LT-F King Quad 4WDX 300 1991 1998 32800-19B00
产品单重	带包装149.3克净重119.8克			
检测程序	308			
电线插头	20CM			
内盒尺寸	12*9.5*6CM			
外箱尺寸	49.5*25.5*30.5CM			
输出电压	14.5±0.5V			
一箱只数	50			
铝壳尺寸				
重要说明	铝壳 无缺口			
产品编号	R2015.3A		 <ol style="list-style-type: none"> 1. Battery (+) 2. GND 3. Power Coil 4. Power Coil 5. Power Coil 	Suzuki DR S 200 2015 2017 32800-19B11 Suzuki DR-Z 400 2009 32800-13E11 Suzuki DR-Z 250 2001 2007 32800-13E10 Suzuki LT QuadRunner 4WD 250 1987 1996 32800-19B10 Suzuki LT-F QuadRunner 4WD 250 1997 1998 32800-19B00 Suzuki LT-F King Quad 4WDX 300 1991 1998 32800-19B00
产品单重	130克			
检测程序	308			
电线插头	20CM			
内盒尺寸	12*9.5*6CM			
外箱尺寸	49.5*25.5*30.5CM			
输出电压	14.5±0.5V			
一箱只数	50			
铝壳尺寸				
重要说明	铝壳有缺口			
产品编号	R2015.4		 <ol style="list-style-type: none"> 1. Power Coil / Bobina de Carga 2. Power Coil / Bobina de Carga 3. Power Coil / Bobina de Carga 4. Battery (+) / Bateria (+) 5. GND / Masa 	Beta AL 200 2012 Beta Chrono 250 Beta Chrono 200 Beta Motard 250 Beta Motard 200 Euromot GTX B 250 Gilera SMX 400 Mondial TD 200 2013 Mondial VD 250 2013 Reem lazo Shin ngen SH572A-12 Suzuki EN 125 2003 2008 32800-29B00
产品单重	130克			
检测程序	308			
电线插头	20CM			
内盒尺寸	12*9.5*6CM			
外箱尺寸	49.5*25.5*30.5CM			
输出电压	14.5±0.5V			
一箱只数	50			
铝壳尺寸				
重要说明	一般成品要配对插			

产品资料1		实物主图	接口图	适用范围
产品编号	R2015.4.1		 <p>1. Ignition Switch/ Sensor 2. Battery (+) / Batería (+) 3. GND / Masa</p> <p>4. Power Coil / Bobina de Carga 5. Power Coil / Bobina de Carga 6. Power Coil / Bobina de Carga</p>	2489 Honda NX 250 1988 31600-KW3-000 Honda NX 250 1989 1993 31600-KW3-010 Reem lazo ietcard 1182 SH572MB[37]
产品单重	130克			
检测程序	308 2489			
电线插头	50CM			
内盒尺寸	12*9.5*6CM			
外箱尺寸	49.5*25.5*30.5CM			
输出电压	14.5±0.5V 20安培			
一箱只数	50			
铝壳尺寸				
重要说明				
产品编号	R2015.4.2		 <p>1. Power Coil / Bobina de Carga 2. Power Coil / Bobina de Carga 3. Power Coil / Bobina de Carga</p> <p>4. GND / Masa 5. Battery (+) / Batería (+)</p>	2408 20A Reem lazo Shin ngen SH572MB Suzuki AN 125 2000 32800-22D11 Suzuki AN Burgman 250 1996 2000 32800-22D10 Suzuki AN Burgman 125 1995 2000 32800-22D10 Suzuki EN 125 2004 2008 32800-22D20 Suzuki EN A2 125 32800-37G10-000 Suzuki GN 125 32800-37G10-000 Suzuki GSX 250 1991 1997 32800-
产品单重	130克			
检测程序	308 2408 2396			
电线插头	20CM			
内盒尺寸	12*9.5*6CM			
外箱尺寸	49.5*25.5*30.5CM			
输出电压	14.5±0.5V 25安培			
一箱只数	50			
铝壳尺寸				
重要说明	铝壳有缺口			
产品编号	R2015.5		 <p>1. Power Coil / Bobina de Carga 2. Power Coil / Bobina de Carga 3. Power Coil / Bobina de Carga</p> <p>4. Battery (+) / Batería (+) 5. GND / Masa</p>	Suzuki GN125
产品单重	130克			
检测程序	308			
电线插头	20CM			
内盒尺寸	12*9.5*6CM			
外箱尺寸	49.5*25.5*30.5CM			
输出电压	14.5±0.5V			
一箱只数	50			
铝壳尺寸				
重要说明				
产品编号	R2015.5.2		 <p>1. GND / Masa 2. Battery (+) / Batería (+)</p> <p>3. Power Coil / Bobina de Carga 4. Power Coil / Bobina de Carga 5. Power Coil / Bobina de Carga</p>	2511 Kawasaki KLX R / SR 400 s 2004 21066-S005 Reem lazo Shin ngen SH572E-12 Suzuki DR-Z S 400 2000 2017 32800-29F00 Suzuki DR-Z 400 2000 2004 32800-08D00 Suzuki DR-Z E 400 2004 2007 32800-29F00 Suzuki RM X 250 1998 1999 32800-
产品单重	130克			
检测程序	308 2511			
电线插头	25CM			
内盒尺寸	12*9.5*6CM			
外箱尺寸	49.5*25.5*30.5CM			
输出电压	14.5±0.5V 20			
一箱只数	50			
铝壳尺寸				
重要说明				

产品资料1		实物主图	接口图	适用范围
产品编号	R2015.7			Suzuki 32801-94J00 Suzuki 32801-94J01 Suzuki DF9.9 2005-2009 Suzuki DF15 2004-2012
产品单重	130克			
检测程序	308			
电线插头	25CM			
内盒尺寸	12*9.5*6CM			
外箱尺寸	49.5*25.5*30.5CM			
输出电压	14.5±0.5V			
一箱只数	50			
铝壳尺寸				
重要说明				
产品编号	R2015.8		 <p>1. Power Coil / Bobina de Carga 2. Power Coil / Bobina de Carga 3. Power Coil / Bobina de Carga 4. Battery (+) / Bateria (+) 5. GND / Masa</p>	Yamaha YFB 250 1997 4KB-81960-01 Yamaha YFB Timberwolf 250 1997 4KB-81960-01 Yamaha YFB Timberwolf 250 1998 2000 4KB-81960-02 Yamaha YFM Kodiak 400 1996 1997 4KB-81960-01 Yamaha YFM Wolverine 350 1996 1997 4KB-81960-01 Yamaha YFM 350 1997 4KB-81960-01 Yamaha YFM Grizzly 600 1998 4KB-32800-09300 32800-24500 32800-43400 32800-44230 32800-45240 32800-47120 Suzuki LT 230 E Quadrunner 1987 Suzuki LT 230 G Quadrunner 1985-1993 Suzuki LT 300 E Quadrunner 1987-1989 Suzuki LTF 250 Quadrunner Manual 1988-1989 Suzuki GS1100E 1982-1983 Suzuki GS1100ES 1983 Suzuki GS1100G 1982-1983 Suzuki GS1100GL 1983
产品单重	130克			
检测程序	308 2343			
电线插头	20CM			
内盒尺寸	12*9.5*6CM			
外箱尺寸	49.5*25.5*30.5CM			
输出电压	14.5±0.5V 25安培			
一箱只数	50			
铝壳尺寸				
重要说明	铝壳有缺口			
产品编号	R2015.8.1		 <p>1. Power Coil 2. Battery (+) 3. Power Coil 4. Power Coil 5. GND</p>	SUZUKI RM-Z250 RMZ250 2010 2011 2012 2013
产品单重	130克			
检测程序	308			
电线插头	20CM			
内盒尺寸	12*9.5*6CM			
外箱尺寸	49.5*25.5*30.5CM			
输出电压	14.5±0.5V			
一箱只数	50			
铝壳尺寸				
重要说明	铝壳有缺口			
产品编号	R2015.9		 <p>1. Power Coil 2. GND 3. Power Coil 4. Battery (+)</p>	SUZUKI RM-Z250 RMZ250 2010 2011 2012 2013
产品单重	130克			
检测程序	208			
电线插头	15CM			
内盒尺寸	12*9.5*6CM			
外箱尺寸	49.5*25.5*30.5CM			
输出电压	14.5±0.5V			
一箱只数	50			
铝壳尺寸				
重要说明				

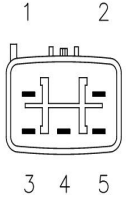

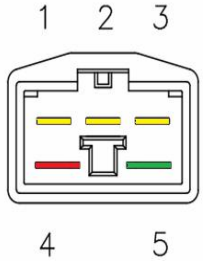

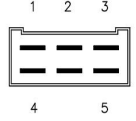

产品资料1		实物主图	接口图	适用范围
产品编号	R2015.10		 <ol style="list-style-type: none"> 1. Battery (+) / Bateria (+) 2. Ignition Switch / Sensor 3. GND / Masa 4. Power Coil / Bobina de Carga 5. Power Coil / Bobina de Carga 	产品编号2015.10 OEM: 54B-H1960-00 Note: please check the model and year of the motorcycle with the following list. YBR125 JYM125 WY125C JH125 FZ16 AKT150 Yamaha XT 125 R 2007 REGULATOR
产品单重	130克			
检测程序	308			
电线插头	5针插头			
内盒尺寸	100*85*30MM			
外箱尺寸	49.5*25.5*30.5CM			
输出电压	14.5±0.5V			
一箱只数	50			
铝壳尺寸				
重要说明				
产品编号	R2015.10.1		 <ol style="list-style-type: none"> 1. AC Generator / Generador 2. GND / Masa 3. Battery (+) / Bateria (+) 4. AC Generator / Generador 5. Lights (+) / Luces (+) 	Keller Big KN110-7 110 Keller Crono Classic KN110-8 110 Keller Crono Classic KN125-11 125 Keller Crono Trial KN125-12 125 Keller Crono Tuning KN125-11 125 Keller Excellence KN150-3 150 Keller Excellence KN250-3 250 Keller Miracle KN150GY 150 Keller Stratus KN260 260 Keller Stratus KN150-13 150 Keller Titan KN110-10 110
产品单重	130克			
检测程序	208			
电线插头	5针插头			
内盒尺寸	100*85*30MM			
外箱尺寸	49.5*25.5*30.5CM			
输出电压	14.5±0.5V			
一箱只数	50			
铝壳尺寸				
重要说明				
产品编号	待 确认的项目		 <ol style="list-style-type: none"> 1. GND / Masa 2. Ignition Switch / Sensor 3. Battery (+) / Bateria (+) 4. Power Coil / Bobina de Carga 5. Power Coil / Bobina de Carga 	Honda 31600-890-951, 31600-ZE2-861, 230-22065; 230-58017 ARROWHEAD AHA6020, 230-58017 ARROWHEAD (OEM) ESP2320 HONDA 31600-890-951, 31600-ZE2-861 J & N 230-58017 J & N (OLD) 230-22044, 230-22065 SHINDENGEN SH547-12
产品单重	130克			
检测程序	308 2372			
电线插头	5针插头			
内盒尺寸	100*85*30MM			
外箱尺寸	49.5*25.5*30.5CM			
输出电压	14.5±0.5V 12V12A			
一箱只数	50			
铝壳尺寸				
重要说明				
产品编号	R2015.10.5		 <ol style="list-style-type: none"> 1. Battery (+) 2. GND 3. Power Coil 4. Power Coil 5. Power Coil 	钱江QJ250F Vespa ET4 Voltage Regulator Rectifier ET 4 150 iaggio S003810-37 piaggio Aprilia Vespa S annungsregler 82501R S annungsregler incl. Blinkrelais Für Aprilia Gilera Runner, Vespa 82501R Hersteller Mo ll Ty Hubraum Fahrgestell Marca Modelo Versión Cilindrada Año
产品单重	130克			
检测程序	308 2372			
电线插头	5针插头			
内盒尺寸	100*85*30MM			
外箱尺寸	49.5*25.5*30.5CM			
输出电压	14.5±0.5V 12V12A			
一箱只数	50			
铝壳尺寸				
重要说明				



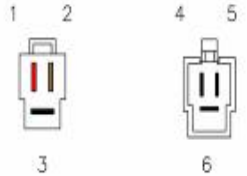

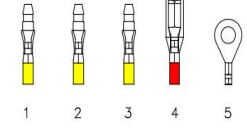
产品资料1		实物主图	接口图	适用范围
产品编号	R2015.10.7		 <ol style="list-style-type: none"> 1. Lights (+) / Luces (+) 2. Battery (+) / Bateria (+) 3. GND / Masa 4. AC Generator / Generador 5. AC Generator / Generador 6. AC Generator / Generador 	Corven Energy 110 Gilera G1 250 2013 21066-1038, SH548-12 21066-1039 SH552-12 Kawasaki KL650 KLR650 KLF220 Bayou 215cc 1996-11 ZN1300 Voyager 1300 ZR550 Ze hydr 550 ZX550 G z 550 ZX750 750R G z ER KDX KMX KR G a p r. 21066-1038, SH548-12 21066-1039 SH552-12
产品单重	130克			
检测程序	308			
电线插头	6针插头			
内盒尺寸	100*85*30MM			
外箱尺寸	49.5*25.5*30.5CM			
输出电压	14.5±0.5V			
一箱只数	50			
铝壳尺寸				
重要说明				
产品编号	R2015.10.7		 <ol style="list-style-type: none"> 1. Lights (+) / Luces (+) 2. Battery (+) / Bateria (+) 3. GND / Masa 4. AC Generator / Generador 5. AC Generator / Generador 6. AC Generator / Generador 	DAE-31600-BA6-0000 DAELIM > VJ 125 (Roadwin) DAELIM > NS 125 (Bj.98) DAELIM > Otello (Bj.'99) DAELIM > Otello (Bj.'00) DAELIM > Otello (Bj.'00) DAELIM > Otello (Bj.'01) DAELIM > Otello DLX (Bj.'02) DAELIM > Otello DLX (Bj.'03) DAELIM > Otello Eco Euro II (ab Bi.04)
产品单重	130克			
检测程序	308			
电线插头	6针插头			
内盒尺寸	100*85*30MM			
外箱尺寸	49.5*25.5*30.5CM			
输出电压	14.5±0.5V			
一箱只数	50			
铝壳尺寸				
重要说明				
产品编号	R2015.10.8		 <ol style="list-style-type: none"> 1. Battery (+) / Bateria (+) 2. GND / Masa 3. Power Coil / Bobina de Carga 4. Power Coil / Bobina de Carga 5. Power Coil / Bobina de Carga 	YAMAHA XC125
产品单重	130克			
检测程序	308			
电线插头	6插只用5针			
内盒尺寸	100*85*30MM			
外箱尺寸	49.5*25.5*30.5CM			
输出电压	14.5±0.5V			
一箱只数	50			
铝壳尺寸				
重要说明				
产品编号	R2015.20		 <ol style="list-style-type: none"> 1. Battery (+) / Bateria (+) 2. GND / Masa 3. Power Coil / Bobina de Carga 4. Power Coil / Bobina de Carga 5. Power Coil / Bobina de Carga 	HYOSUNG GT125, GT125R, GT250, GT250R, GA125, RX125, GPS125, MIR RECTIFIER NRR51 32800HG1412 32800HN9150
产品单重	130克			
检测程序	308			
电线插头	6插只用5针			
内盒尺寸	100*85*30MM			
外箱尺寸	49.5*25.5*30.5CM			
输出电压	14.5±0.5V			
一箱只数	50			
铝壳尺寸				
重要说明				

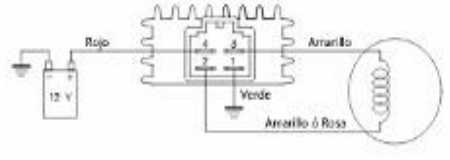

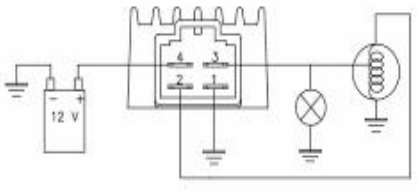

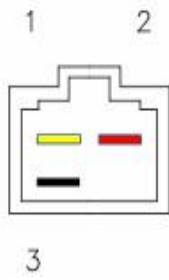

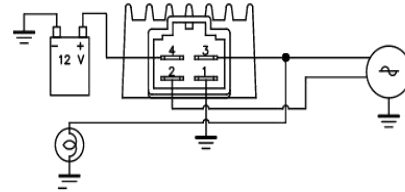
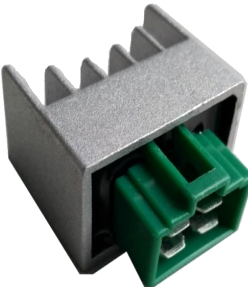
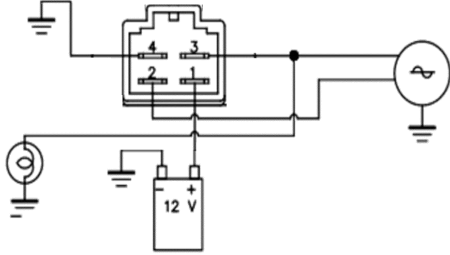
产品资料1		实物主图	接口图	适用范围
产品编号	R2015.11		 <ol style="list-style-type: none"> 1. Battery (+) / Bateria (+) 2. GND / Masa 3. Power Coil / Bobina de Carga 4. Power Coil / Bobina de Carga 	Kawasaki Ultra JET SKI 150 1999 2005 21066-3715
产品单重	130克			
检测程序	308			
电线插头	6插只用4针			
内盒尺寸	100*85*30MM			
外箱尺寸	49.5*25.5*30.5CM			
输出电压	14.5±0.5V			
一箱只数	50			
铝壳尺寸				
重要说明				
产品编号	R2015.11+D		 <ol style="list-style-type: none"> 1. Battery (+) / Bateria (+) 2. GND / Masa 3. Power Coil / Bobina de Carga 4. Power Coil / Bobina de Carga 5. Power Coil / Bobina de Carga 	Kawasaki 1066-3715 21066-3715 Kawasaki 1200 STX-R 2002-2005 21066-3716 Kawasaki Ultra 150 1999-2005 舷外机整流器 21066-3715 21066-3716 21066-S004 21066-S011
产品单重	130克			
检测程序	308			
电线插头	6插只用5针			
内盒尺寸	12*9.5*6CM			
外箱尺寸	49.5*25.5*30.5CM			
输出电压	14.5±0.5V			
一箱只数	50			
铝壳尺寸				
重要说明				
产品编号	R2015.12		 <ol style="list-style-type: none"> 1. Power Coil 2. Power Coil 3. Power Coil 4. Battery (+) 5. GND 	Aprilia RXV 550 A 9100424 Aprilia RXV 450 A 9100424 Aprilia SXV 450 A 9100424 Aprilia SXV 550 A 9100424 Honda CB F A/C 400 from 1989 to 1990 31600-MV4-000 Honda CB A/AC 250 from 1991 to 2007 31600-MV4-000 Honda CB 500 from 1993 to 2003 31600-MV4-000 Honda NSS AC 250 from 2001 to 2003
产品单重	130克			
检测程序	308			
电线插头	5针插头			
内盒尺寸	100*85*30MM			
外箱尺寸	49.5*25.5*30.5CM			
输出电压	14.5±0.5V			
一箱只数	50			
铝壳尺寸				
重要说明				
产品编号	R2015.13		 <ol style="list-style-type: none"> 1. Power Coil / Bobina de Carga 2. Power Coil / Bobina de Carga 3. Power Coil / Bobina de Carga 4. Battery (+) / Bateria (+) 5. Ignition Switch / Sensor 6. GND / Masa 	Aprilia RS 125 Regulator Rectifier SH572-12 RS125 Aprilia Classic 125 from 1995 to 1999 A 8112906 Aprilia Leonardo 150 from 1996 to 2004 A 8112906 Aprilia Leonardo 125 from 1996 to 2004 A 8112906 Aprilia MX 125 from 2004 to 2006 A 8112906 Aprilia egaso 650 from 1992 to 1995
产品单重	130克			
检测程序	308 2459			
电线插头	15 20CM			
内盒尺寸	12*9.5*6CM			
外箱尺寸	49.5*25.5*30.5CM			
输出电压	14.5±0.5V 20安培			
一箱只数	50			
铝壳尺寸				
重要说明	红正蓝负 绿白检测线			

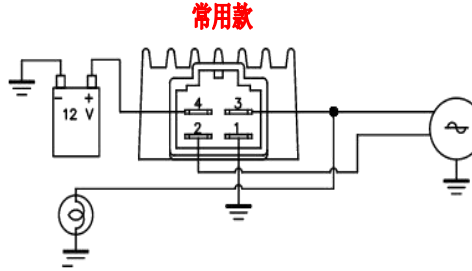

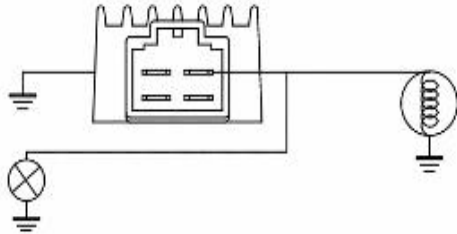

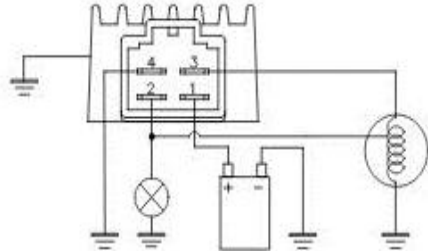

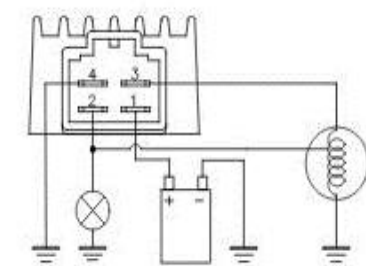
产品资料1		实物主图	接口图	适用范围
产品编号	R2015.14			仿大小公主摩托车充电整流器GY6四线直流充电器整流器
产品单重	130克			
检测程序	308			
电线插头	25CM			
内盒尺寸	12*9.5*6CM			
外箱尺寸	49.5*25.5*30.5CM			
输出电压	14.5±0.5V			
一箱只数	50			
铝壳尺寸				
重要说明				
产品编号	R2015.15		 <p>1. Power Coil / Bobina de Carga 2. Power Coil / Bobina de Carga 3. Power Coil / Bobina de Carga 4. Battery (+) / Bateria (+) 5. GND / Masa</p>	Honda 31600-KAK-781 Honda 31600-KAK-900 Honda CRM125 1990-1999
产品单重	130克			
检测程序	308			
电线插头	35CM			
内盒尺寸	12*9.5*6CM			
外箱尺寸	49.5*25.5*30.5CM			
输出电压	14.5±0.5V			
一箱只数	50			
铝壳尺寸				
重要说明				
产品编号	R2015.16			北极猫400 500 2 X 4 / 4 X 4 / 手动 2000 2001 OEM re 1.# 0530 - 006 0530 - 137
产品单重				
检测程序	M25			
电线插头	35CM			
内盒尺寸	12*9.5*6CM			
外箱尺寸	49.5*25.5*30.5CM			
输出电压	14.5±0.5V			
一箱只数	50			
铝壳尺寸				
重要说明	铝壳有缺口			
产品编号	R2015.17			Honda CLR125 X City Fly 99-03 SH572B-11
产品单重				
检测程序	M25			
电线插头	35CM			
内盒尺寸	12*9.5*6CM			
外箱尺寸	49.5*25.5*30.5CM			
输出电压	14.5±0.5V			
一箱只数	50			
铝壳尺寸				
重要说明				

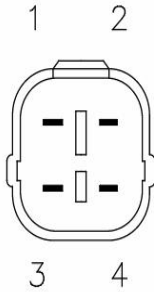
产品资料1		实物主图	接口图	适用范围
产品编号	R2015.18			Honda 31600-KAE-741 Honda CRM250 CRM250AR 1995-1999
产品单重				
检测程序	308			
电线插头	125CM			
内盒尺寸	12*9.5*6CM			
外箱尺寸	49.5*25.5*30.5CM			
输出电压	14.5±0.5V			
一箱只数	50			
铝壳尺寸				
重要说明				
产品编号	R2015.19			Honda CRM250 1989-1999
产品单重				
检测程序	308			
电线插头	80 125CM			
内盒尺寸	12*9.5*6CM			
外箱尺寸	49.5*25.5*30.5CM			
输出电压	14.5±0.5V			
一箱只数	50			
铝壳尺寸				
重要说明				
产品编号	R2015.20			Honda XR250L 1991-1996
产品单重				
检测程序	308			
电线插头	25CM			
内盒尺寸	12*9.5*6CM			
外箱尺寸	49.5*25.5*30.5CM			
输出电压	14.5±0.5V			
一箱只数	50			
铝壳尺寸				
重要说明	铝壳有缺口			
产品编号	R2015B.0			YBR125 天剑125 YB125E/S 天戟 天骐 天剑 川崎 KLX140L 雅马哈: VINO YYJ YJ 50 ; YI125 ; Yj50rn ; DTR 125 ; RT180 ; TTR90 TIGER是东南亚的名称 12A MBK MACH G OE 5RH-H196 KAWASAKI G Z 750 REGULATOR RECTIFIER Regulator Rectifier CBR600RR 03- 06, RVT1000R RC51 00-01 SH561-12 21066-1052
产品单重	120克			
检测程序	208			
电线插头	5针插头			
内盒尺寸	12*9.5*6CM			
外箱尺寸	49.5*25.5*30.5CM			
输出电压	14.5±0.5V			
一箱只数	50			
铝壳尺寸				
重要说明				

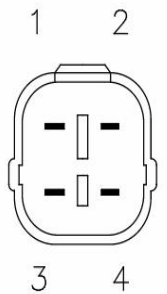

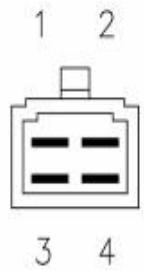

产品资料1		实物主图	接口图	适用范围
产品编号	R2015B.1		 <p>1. Battery (+) / Bateria (+) 2. Ignition Switch/ Sensor 3. GND / Masa 4. Power Coil / Bobina de Carga 5. Power Coil / Bobina de Carga 6. Power Coil / Bobina de Carga</p>	Yamaha SR 125 5H0-81960-A0 5H0-H0 SH239 1987-1996 RZ125 SR125 SR185 RD125LC TZR125
产品单重	160克盒重			
检测程序	308 削线路板			
电线插头	15 25 CM			
内盒尺寸	12*9.5*6CM			
外箱尺寸				
输出电压	14.5±0.5V			
一箱只数	50			
铝壳尺寸				
重要说明				
产品编号	R2015B.2		 <p>1. Power Coil / Bobina de Carga (Yellow/ Amarillo) 2. Power Coil / Bobina de Carga (Yellow/ Amarillo) 3. Power Coil / Bobina de Carga (Yellow/ Amarillo) 4. Battery (+) / Bateria (+) 5. GND/ Masa</p>	2352 25A Reem lazo Shin ngen SH590A-13 Suzuki - 32800-49X50 Suzuki - 32800-47121 Suzuki GS T 750 1982 1983 32800-47120 Suzuki GS L 450 1982 32800-44120 Suzuki GS E 650 1981 1982 32800-47020 Suzuki GS E 500 1982 1983 32800-47120
产品单重	240克			
检测程序	325 2303 2352			
电线插头	25CM			
内盒尺寸	12*9.5*6CM			
外箱尺寸	49.5*25.5*30.5CM			
输出电压	14.5±0.5V 25安培			
一箱只数	50			
铝壳尺寸				
重要说明				
产品编号	R2016.0			10154 Betamotor BS 110 Betamotor BS 100 Betamotor RB 100 Cerro Mov 125 Cerro R9 CE T-8 125 Corven Energy Tunning J 110 s 2010 Corven Mirage AD J 110 s 2010 Corven Mirage RT J 110 s 2010 Da Dalt DS 110
产品单重	103克			
检测程序	208 10154			
电线插头	4针插头			
内盒尺寸	100*85*30MM			
外箱尺寸	49.5*25.5*30.5CM			
输出电压	14.5±0.5V 12安培			
一箱只数	100			
铝壳尺寸				
重要说明				
产品编号	R2016.1			10108 12V 8A Gilera Smash 110 Zanella ZB 110 hasta 2010 2390 Beta Foxter 110 Beta anda 70 Cerro Sunny 50 Chirette AF 50 Guerrero GFT Ma uche 110 Konisa ATV Mini 110 Reem lazo ietcard 1298
产品单重	103克 净重84克			
检测程序	半波HS08 10108 2390			
电线插头	4针插头			
内盒尺寸	100*85*30MM			
外箱尺寸	49.5*25.5*30.5CM			
输出电压	14.5±0.5V 8A			
一箱只数	100			
铝壳尺寸				
重要说明				







产品资料1		实物主图	接口图	适用范围
产品编号	R2016.2		 <p>1. Power Coil 2. Battery (+) 3. GND</p>	大江整流器
产品单重	103克 净重84克			
检测程序	半波HS08			
电线插头	4针插头只用3 针			
内盒尺寸	100*85*30MM			
外箱尺寸	49.5*25.5*30.5CM			
输出电压	14.5±0.5V 8A			
一箱只数	100			
铝壳尺寸				
重要说明				
产品编号	R2017.0			2558 Honda 31600-GAG-K20 Honda CRF F 230 2005 2009 31600-GAG-K21 Honda CRF F 230 2012 2017 31600-GAG-K21 Honda CRF F 150 2006 2009 31600-GAG-K21 Honda CRF F 150 2012 2017 31600-GAG-K21 Reem lazo Shin ngen SH634DA
产品单重	净重45克, 盒重 55克			
检测程序	半波HS08 2558			
电线插头	4针插头			
内盒尺寸				
外箱尺寸	49.5*25.5*30.5CM			
输出电压	14.5±0.5V 12安培			
一箱只数	200			
铝壳尺寸				
重要说明	黑白插头线路通用 绿插头正负出线相			
产品编号	R2017.1			1054 BetamotorGrin r100 HondaBiz125 s 2016 HondaCGTitan15031600-KRM-851 HondaNXRBros15031600-KRM-851 HondaWave110 s 201431600-K09-C01 Reem lazo ietcard1424 Reem lazo ietcard1047 YamahaCrux110 YamahaCry tonNew110 s 20124S9-H1960-00
产品单重				
检测程序	半波HS08 10054			
电线插头	4针插头			
内盒尺寸	100*85*30MM			
外箱尺寸	49.5*25.5*30.5CM			
输出电压	14.5±0.5V 12安培			
一箱只数	200			
铝壳尺寸				
重要说明				
产品编号	R2019.0		 <p>常用款</p>	2075 JF2-81910-00-00 MondialFD125 anther-90 Reem lazo ietcard1258 Reem lazo ietcard1335 Reem lazo ietcard1351 Reem lazo ietcard1030 ZanellaZCT150 ZanellaZCT125
产品单重	70			
检测程序	半波HS08 2075 10105 10155 2012 20			
内盒尺寸	100*85*30MM			
外箱尺寸	49.5*25.5*30.5CM			
输出电压	14.5±0.5V 8A			
一箱只数	200			
铝壳尺寸				
重要说明				

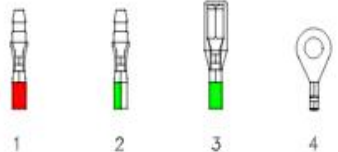
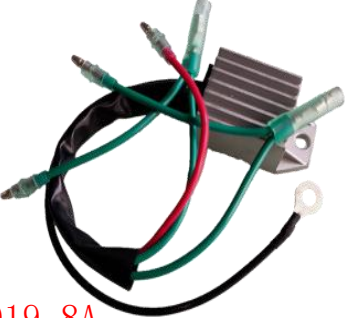
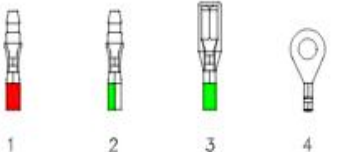

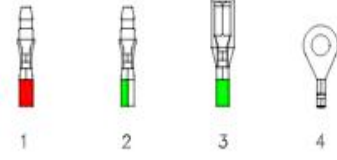
产品资料1		实物主图	接口图	适用范围
产品编号	R2019.01			2085 8A CA+CC Gilera GA 4T 50 32500-24Y00 Gilera GA 4T 70 32500-24Y00 Reem lazo ietcard 1220 2019 8A Reem lazo ietcard 1213 Suzuki DR 250 1990 1993 32500-14D00 Suzuki DR 350 1990 1999 32500-14D00 Suzuki RMX 250 1989 1998 32500-14D00
产品单重	100克一箱只数200			
检测程序	半波HS08 2085 2019 CA+CC			
电线插头	4针插头只用2 针			
内盒尺寸	100*85*30MM			
外箱尺寸	49.5*25.5*30.5CM			
输出电压	14.5±0.5V 8A			
一箱只数	100			
铝壳尺寸				
重要说明				
产品编号	R2019.02			2017 8A CA+CC Reem lazo ietcard 1008 Reem lazo Shin ngen SH582A-12 Suzuki Address AD 100 Suzuki Address AD 60 Suzuki Address AD 50
产品单重	100克一箱只数200			
检测程序	半波HS08 2017 外壳接地			
电线插头	4针插头+外壳接地			
内盒尺寸	100*85*30MM			
外箱尺寸	49.5*25.5*30.5CM			
输出电压	14.5±0.5V 8A			
一箱只数	100			
铝壳尺寸				
重要说明				
产品编号	R2019.03			2010 8A CA+CC Reem lazo ietcard 1037 Reem lazo Shin ngen SH649A-12 Reem lazo Shin ngen SH582-12 Suzuki TS ER 125 1990 1994 32800-31C21 Suzuki TS ER 185 2005 32800-31C21 Suzuki TS ER 185 1996 2001 32800-31C21 Suzuki TS ER 125 1982 32800-31C21 Yamaha CG Jog 50 1988 1991 2JA-
产品单重	100克一箱只数200			
检测程序	半波HS08 2010 CA+CC			
电线插头	4针插头			
内盒尺寸	100*85*30MM			
外箱尺寸	49.5*25.5*30.5CM			
输出电压	14.5±0.5V 8A			
一箱只数	100			
铝壳尺寸				
重要说明				
产品编号	R2019.1		 <ul style="list-style-type: none"> 1. GND 绿线 2. Power Coil 白线 大灯 3. Power Coil 黄线 4. Battery (+) 红线 	2401 Reem lazoShin ngenSH723AA YamahaYFABreeze100 1998 20033GB-81960-10 YamahaYFABreeze10020045TH-81960-01 YamahaYFMRa tor50 2004 20085TH-81960-01 YamahaYFMBadger80 1997 20013GB-81960-10 YamahaYFMGrizzly80 2005 20085TH-81960-01 YamahaYFMRa tor80 2005 20085TH-
产品单重	克一箱只数200			
检测程序	HS08半波 2401 2513 白线大灯			
电线插头	15CM			
内盒尺寸	100*85*30MM			
外箱尺寸	49.5*25.5*30.5CM			
输出电压	14.5±0.5V 12安培			
一箱只数	200			
铝壳尺寸				
重要说明				

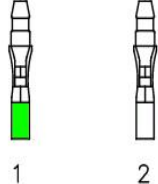

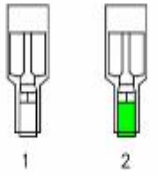

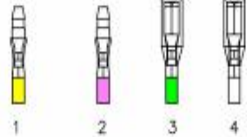

产品资料1		实物主图	接口图	适用范围
产品编号	R2019.1.1		 <p>1. GND 绿线 2. Power Coil 白线 大灯 3. Power Coil 黄线 4. Battery (+) 红线</p>	KTM 660 SMC 2004-2005 KTM 125 SX TYLA RATTRAY 2005 KTM 525 MXC-G RACING 2005-2006 KTM 250 EXC RACING 2006 KTM 400 EXC-G RACING 2005-2006 KTM 450 EXC RACING 2006 KTM 450 EXC-G RACING 2005-2006 KTM 450 XC-G RACING 2006 KTM 525 XC-G RACING 2006 KTM 200 EXC 2005-2007 KTM 250 EXC 2005-2007
产品单重	100克一箱只数200			
检测程序	HS08半波			
电线插头	15CM			
内盒尺寸	100*85*30MM			
外箱尺寸	49.5*25.5*30.5CM			
输出电压	14.5±0.5V			
一箱只数	100			
铝壳尺寸				
重要说明				
产品编号	R2019.2		 <p>1. Battery (+) 2. Power Coil 交流照明 3. Power Coil 4. GND</p>	2008 - 2013 Polaris/北极星 Outlaw 50 2007 - 2014 Polaris Outlaw 90 2007 Polaris redator 50 2007 - 2014 Polaris Sportsman 90 ATV
产品单重				
检测程序	HS08半波			
电线插头	15CM			
内盒尺寸	100*85*30MM			
外箱尺寸	49.5*25.5*30.5CM			
输出电压	14.5±0.5V			
一箱只数	100			
铝壳尺寸				
重要说明				
产品编号	R2019.3		 <p>1. Battery (+) 红线 2. Power Coil 黄线 3. Power Coil 白线 大灯 4. GND 绿线</p>	Kymco 10-702 Kymco Mongoose 90 2009 2010 2011 2006 - 2007 Kymco MONGOOSE 50 2X4 2006 - 2007 Kymco Mongoose 50 4T 2007 Kymco MONGOOSE 70 2X4 2004 - 2007 Kymco Mongoose 90 2004 - 2007 Kymco MONGOOSE 90 2X4
产品单重				
检测程序	HS08半波			
电线插头	15CM			
内盒尺寸	100*85*30MM			
外箱尺寸	49.5*25.5*30.5CM			
输出电压	14.5±0.5V			
一箱只数	100			
铝壳尺寸				
重要说明				
产品编号	R2019.3.1		 <p>1. Power Coil / Bobina de Carga 2. Power Coil / Bobina de Carga 3. GND / Masa 4. Battery (+) / Bateria (+)</p>	2559 31600-MEY-671 Sh728AB HondaCRFX250 2012 201331600-KSC-671 HondaCRFX250 2004 200931600-KSC-671 HondaCRFX250 2015 201731600-KSC-671 2060 HondaCRFX450 2005 200931600-MEY-671 HondaCRFX450 2012 201731600-MEY-671
产品单重				
检测程序	HS08半波 2559 2560			
电线插头	15CM			
内盒尺寸	100*85*30MM			
外箱尺寸	49.5*25.5*30.5CM			
输出电压	14.5±0.5V 12安培			
一箱只数	100			
铝壳尺寸				
重要说明				

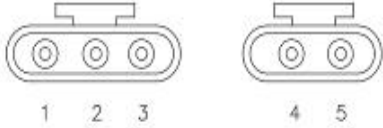



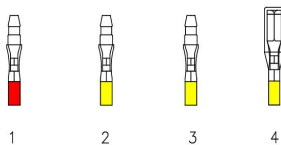

产品资料1		实物主图	接口图	适用范围
产品编号	R2019.4		 <p>1. Battery (+) 2. Power Coil 2 交流+大灯 3. Power Coil 4. GND</p>	2358 CA+CC 12V8A Yamaha G 1200 1997 1999 SH-643-13 / 6H2-81960-00 Yamaha G 12006H2-81960-00 Yamaha SUV12006H2-81960-00 Yamaha SUV1200 2000 6H2-81960-00 Yamaha SUV1200 1997 2000 SH-643-13 / 6H2-81960-00
产品单重	盒重90克			
检测程序	HS08半波 2358 8A			
电线插头	10 35CM			
内盒尺寸	100*85*30MM			
外箱尺寸	49.5*25.5*30.5CM			
输出电压	14.5±0.5V 8A			
一箱只数	100			
铝壳尺寸				
重要说明	默认是白色外壳			
产品编号	R2019.4A		 <p>1. Battery (+) / Batería (+) (Red/ Rojo) 2. Power Coil / Bobina de Carga (Green-White/ Verde-Blanco) 3. Power Coil / Bobina de Carga (Green/Verde) 4. GND / Masa</p>	Yamaha G 1200 1997 1999 SH-643-13 / 6H2-81960-00 Yamaha G 1200 6H2-81960-00 Yamaha SUV 1200 6H2-81960-00 Yamaha SUV 1200 2000 6H2-81960-00 Yamaha SUV 1200 1997 2000 SH-643-13 / 6H2-81960-00
产品单重	240			
检测程序	HS08半波 2358 8A			
电线插头	5 20 30CM			
内盒尺寸	100*85*30MM			
外箱尺寸	49.5*25.5*30.5CM			
输出电压	14.5±0.5V			
一箱只数	50			
铝壳尺寸				
重要说明				
产品编号	R2019.4B		 <p>1. Battery (+) / Batería (+) (Red/ Rojo) 2. Power Coil / Bobina de Carga (Green-White/ Verde-Blanco) 3. Power Coil / Bobina de Carga (Green/Verde) 4. GND / Masa</p>	1 cs 4 Dra n Boot Gelijkrichter Fit Universal 2-Takt 15H Marine Boot Buitenboordmotor 1.57x1.38x0.87 "Aluminium legering LD405-1092041-3237139
产品单重	90			
检测程序	208			
电线插头	10 20 25CM			
内盒尺寸	100*85*30MM			
外箱尺寸	49.5*25.5*30.5CM			
输出电压	14.5±0.5V			
一箱只数	100			
铝壳尺寸				
重要说明				
产品编号	R2019.5		 <p>1. Battery (+) / Batería (+) (Red/ Rojo) 2. Power Coil / Bobina de Carga (Green/ Verde) 3. Power Coil / Bobina de Carga (Green/Verde) 4. GND / Masa</p>	Yamaha WB800 1998 2005SH-643A-12 - 63M-81960-00 Yamaha WR1100 1995 1996SH-643A-12 - 63M-81960-00 Yamaha WR1100 63M-81960-00 Yamaha WV1100 997 SH-643A-12 - 63M-81960-00 Yamaha WV1100 63M-81960-00 Yamaha YFM 350 FAS 800 63M-81960-00
产品单重				
检测程序	208 CC 2359 全波			
电线插头	15 红线 其他20 CM			
内盒尺寸	100*85*30MM			
外箱尺寸	49.5*25.5*30.5CM			
输出电压	14.5±0.5V 8A			
一箱只数	100			
铝壳尺寸				
重要说明	实物无胶套			

产品资料1		实物主图	接口图	适用范围
产品编号	R2019.6		 <p>1. GND/ Masa [Black / Negro] 2. Power Coil / Bobina de Carga [White / Blanco] 3. Power Coil / Bobina de Carga [Yellow / Amarillo] 4. Battery (+) / Bateria (+) [Red / Rojo]</p>	Yamaha YFM Badger 80 1992 1996 3GB-81960-00 Yamaha YFM Cham 100 1989 1991 3GB-81960-00 Yamaha YFM Breeze 100 1989 1996 3GB-81960-00
产品单重	克一箱只数200			
检测程序	HS08半波 2439			
电线插头	15CM			
内盒尺寸	100*85*30MM			
外箱尺寸	49.5*25.5*30.5CM			
输出电压	14.5±0.5V 8A			
一箱只数	100			
铝壳尺寸				
重要说明				
产品编号	R2019.7		 <p>1. GND/ Masa [Black / Negro] 2. Power Coil / Bobina de Carga [White / Blanco] 3. Power Coil / Bobina de Carga [Yellow / Amarillo] 4. Battery (+) / Bateria (+) [Red / Rojo]</p>	光阳A博士125
产品单重	克一箱只数200			
检测程序	208			
电线插头	15CM			
内盒尺寸	100*85*30MM			
外箱尺寸	49.5*25.5*30.5CM			
输出电压	14.5±0.5V			
一箱只数	100			
铝壳尺寸				
重要说明				
产品编号	R2019.8		 <p>1. Battery (+) / Bateria (+) (Red/ Rojo) 2. Power Coil / Bobina de Carga (Green-White/ Verde-Blanco) 3. Power Coil / Bobina de Carga (Green/Verde) 4. GND / Masa</p>	32800-95D10 Suzuki Outboard 25H 30H 75H 85H 2T 664-81970-61 Rectifier Assy Yamaha arsun owertec Outboard 6H - 40H 2/4T
产品单重	净重80克, 盒重95克			
检测程序	208			
电线插头	515CM			
内盒尺寸	100*85*30MM			
外箱尺寸	49.5*25.5*30.5CM			
输出电压	14.5±0.5V			
一箱只数	100			
铝壳尺寸				
重要说明				
产品编号	R2019.8A		 <p>1. Battery (+) / Bateria (+) (Red/ Rojo) 2. Power Coil / Bobina de Carga (Green-White/ Verde-Blanco) 3. Power Coil / Bobina de Carga (Green/Verde) 4. GND / Masa</p>	32800-95D10 Suzuki Outboard 25H 30H 75H 85H 2T 664-81970-61 Yamaha arsun owertec Outboard 6H - 40H 2/4T
产品单重	克一箱只数200			
检测程序	208			
电线插头	515CM			
内盒尺寸	100*85*30MM			
外箱尺寸	49.5*25.5*30.5CM			
输出电压	14.5±0.5V			
一箱只数	100			
铝壳尺寸				
重要说明				

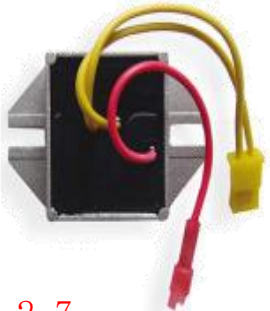
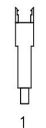
产品资料1		实物主图	接口图	适用范围
产品编号	R2019A.1		 <p>1. Battery (+) / Batería (+) (Red/ Rojo) 2. Power Coil / Bobina de Carga (Green-White/ Verde-Blanco) 3. Power Coil / Bobina de Carga (Green/Verde) 4. GND / Masa</p>	Yamaha G 1200 1997 1999 SH-643-13 / 6H2-81960-00 Yamaha G 1200 6H2-81960-00 Yamaha SUV 1200 6H2-81960-00 Yamaha SUV 1200 2000 6H2-81960-00 Yamaha SUV 1200 1997 2000 SH-643-13 / 6H2-81960-00
产品单重	240			
检测程序	208 全波			
电线插头	6 15 255CM			
内盒尺寸	100*85*30MM			
外箱尺寸	49.5*25.5*30.5CM			
输出电压	14.5±0.5V			
一箱只数	50			
铝壳尺寸				
重要说明				
产品编号	R2019A.2		 <p>1. Power Coil / Bobina de Carga 2. GND / Masa</p>	2563 HondaATCX350 1985 198631400-KG0-008 HondaTLR200 1986 198731400-KJ2-670 HondaXLR250198731410-HA5-671 HondaXLR250198731400-MG2-008 HondaXLR250 1984 198731400-KG0-008 HondaXLR600 1983 198731400-MG2-008 HondaXLR250198731400-KJ2-670 HondaXLR350 1984 198531400-KG0-
产品单重	240			
检测程序	CA 2563 2564			
电线插头	15CM			
内盒尺寸	100*85*30MM			
外箱尺寸	49.5*25.5*30.5CM			
输出电压	14.5±0.5V 12安培			
一箱只数	50			
铝壳尺寸				
重要说明				
产品编号	R2019A.3		 <p>1. Power Coil / Bobina de Carga 2. GND / Masa</p>	2566 HondaXRR600 1991 200031400-MN1-680 HondaXRR650 2000 200731400-MN1-680
产品单重	240			
检测程序	CA 2566			
电线插头	20CM			
内盒尺寸	100*85*30MM			
外箱尺寸	49.5*25.5*30.5CM			
输出电压	14.5±0.5V 12安培			
一箱只数	50			
铝壳尺寸				
重要说明				
产品编号	R2019A.4		 <p>1. Power Coil / Bobina de Carga 2. Power Coil / Bobina de Carga 3. Lamp Output / Salida de Luces 4. GND / Masa</p>	2567 Honda-31410-KCY-670 HondaXRR400 1996 200431410-KCY-671
产品单重	240			
检测程序	HS08半波 2567			
电线插头	15CM			
内盒尺寸	100*85*30MM			
外箱尺寸	49.5*25.5*30.5CM			
输出电压	14.5±0.5V 12安培			
一箱只数	50			
铝壳尺寸				
重要说明				

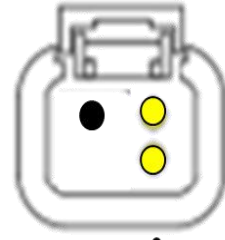
产品资料1		实物主图	接口图	适用范围
产品编号	R2019A.5		 <p>1. Power Coil / Bobina de Carga 2. Power Coil / Bobina de Carga 3. GND / Masa 4. Lamps Output / Salida de Luces</p>	2565 HondaXRR250 1990 200431410-KZ1-670
产品单重	240			
检测程序	CA 2565			
电线插头	15CM			
内盒尺寸	100*85*30MM			
外箱尺寸	49.5*25.5*30.5CM			
输出电压	14.5±0.5V 12安培			
一箱只数	50			
铝壳尺寸				
重要说明				
产品编号	R2020.0			7003-RR150 YFZ450 7004-RR150 150W FULL WAVE (全波)
产品单重				
检测程序	215 全波			
电线插头	15CM			
内盒尺寸	12*9.5*6CM			
外箱尺寸	49.5*25.5*30.5CM			
输出电压	14.5±0.5V			
一箱只数	100			
铝壳尺寸				
重要说明				
产品编号	R2020.1		 <p>外壳接地</p>	797375 393374 BRIGGS & STRATTON 394890 BRIGGS & STRATTON 691185 BRIGGS & STRATTON 797182 BRIGGS & STRATTON 797375 BRIGGS & STRATTON 845907 OREGON 33-402 RIME LINE 7-01695 STENS 435-195 百力通调节器
产品单重				
检测程序	215			
电线插头	15CM			
内盒尺寸	12*9.5*6CM			
外箱尺寸	49.5*25.5*30.5CM			
输出电压	14.5±0.5V			
一箱只数	100			
铝壳尺寸				
重要说明				
产品编号	R2020.2		 <p>1. Power Coil / Bobina de Carga 2. Power Coil / Bobina de Carga 3. Power Coil / Bobina de Carga 4. GND / Masa 5. Battery (+) / Bateria (+)</p>	SEA DOO WC JET SKI GSX 800 1997 X 800 1997
产品单重	150克			
检测程序	315			
电线插头	20CM			
内盒尺寸	12*9.5*6CM			
外箱尺寸	49.5*25.5*30.5CM			
输出电压	14.5±0.5V			
一箱只数	100			
铝壳尺寸				
重要说明				

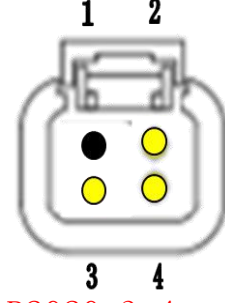
产品资料1		实物主图	接口图	适用范围
产品编号	R2020.2.1		 <p>1. Charge Lamp/ Lámpara Piloto 2. Battery (+) / Batería (+) 3. Power Coil / Bobina de Carga 4. Power Coil / Bobina de Carga</p> <p>Case/ Carcasa: GND/ Masa</p>	Briggs Stratton - 10 / 13 / 16 Am s DC Regulated 493219 Briggs Stratton - Quad Circuit Alternator 493219
产品单重				
检测程序	2152325			
电线插头	15CM			
内盒尺寸	12*9.5*6CM			
外箱尺寸	49.5*25.5*30.5CM			
输出电压	14.5±0.5V 16A			
一箱只数	100			
铝壳尺寸				
重要说明				
产品编号	R2020.2.2		 <p>1. Battery (+) / Batería (+) (Red/ Rojo) 2. Power Coil / Bobina de Carga (Yellow/ Amarillo) 3. Power Coil / Bobina de Carga (Yellow/ Amarillo) 4. Power Coil / Bobina de Carga (Yellow/ Amarillo)</p> <p>Case/ Carcasa: GND/ Masa</p>	舷外机整流器278000443 Sea Doo Challenger 1996 1997 278000443 Sea Doo Challenger 1997 278000443 Sea Doo GSX 1996 278000443 Sea Doo GTX 1994 1997 278000443 Sea Doo S X 1998 1999 278000443 Sea Doo X 1996 278000443
产品单重	160克			
检测程序	308 10151			
电线插头	15CM			
内盒尺寸	12*9.5*6CM			
外箱尺寸	49.5*25.5*30.5CM			
输出电压	14.5±0.5V 12安培			
一箱只数	100			
铝壳尺寸				
重要说明				
产品编号	R2020.2.3			<u>Ski-doo mula III 600 Carb L/C 1999</u> <u>Ski-doo mula III 700 Carb L/C 1999-2000</u> <u>Ski-doo mula III 800 Carb L/C 1999-2000</u> Ski-doo mula Z 600 Carb L/C 2000 Ski-doo mula Z 700 Carb L/C 2000 Ski-doo Mach 1 700 Carb L/C 1999-2000 Ski-doo Mach Z 800 Carb L/C 1999-2001 Ski-doo Mach Z 800 Carb L/C LT 1999
产品单重				
检测程序	208 不确定			
电线插头	15CM			
内盒尺寸	12*9.5*6CM			
外箱尺寸	49.5*25.5*30.5CM			
输出电压	14.5±0.5V			
一箱只数	100			
铝壳尺寸				
重要说明				
产品编号	R2020.2.4			4060122 2203873 4060123 等同 2051.3线路板 4010793 4010301 Polaris Trail Blazer 250 1995 Polaris 440 XCR Carb L/C 1997-1999 Polaris 440 XCR S Carb L/C 1999 Polaris 500 Indy Carb L/C Touring 1996 Polaris 500 Indy Carb L/C Touring Euro 1996 Polaris 500 Indv RMK Carb L/C 2000-
产品单重				
检测程序	QFAC-1 同2051.3			
电线插头	15CM			
内盒尺寸	12*9.5*6CM			
外箱尺寸	49.5*25.5*30.5CM			
输出电压	14.5±0.5V			
一箱只数	100			
铝壳尺寸				
重要说明				

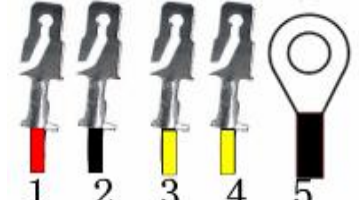
产品资料1		实物主图	接口图	适用范围
产品编号	R2020.2.7		  1. Battery (+) / Batería (+) 2. Power Coil / Bobina de Carga 3. Power Coil / Bobina de Carga Case/ Carcasa: GND/ Masa	Briggs Stratton - 10 / 13 / 16 Am s DC Regulated 691185 Briggs Stratton - 10 Am Alternator 394890 Briggs Stratton - Quad Circuit Alternator 797375 Briggs Stratton - 13 Am DC regulated 393374 JOHN DEERE - 20 H engines MIU12514 JOHN DEERE - 20 H engines LG691185 Toro Lawn Tractor 10 - 16 Am 845907
产品单重				
检测程序	215 2324			
电线插头	15CM			
内盒尺寸	12*9.5*6CM			
外箱尺寸	49.5*25.5*30.5CM			
输出电压	14.5±0.5V 16A			
一箱只数	100			
铝壳尺寸				
重要说明				
产品编号	R2020.3		 1. 正极 (+) 2. 交流 AC 3. 交流 AC 4. 外壳负极 shell GND (-)	Ski-Doo 380F 550F MXZ Re laces 515176188 515176189 Ski-Doo Ex edition 550 2005 Ski-Doo Skandic Tundra 300 2006-2008 Ski-Doo Freestyle 550 2007-2008 Ski-Doo MX Z 5502007 Ski-Doo MX ZX 550 2009
产品单重	145克			
检测程序	215 单相			
电线插头	20CM			
内盒尺寸	12*9.5*6CM			
外箱尺寸	49.5*25.5*30.5CM			
输出电压	14.5±0.5V			
一箱只数	100			
铝壳尺寸				
重要说明				
产品编号	R2020.3.4		 1. 正极 (+) 2. 交流 AC 3. 交流 AC 4. 交流 AC 5. 外壳负极 shell GND (-)	2005 Ski-Doo Ex edition 550F 2005 Ski-Doo MXZ 380F 2005 Ski-Doo MXZ 550F 2006 Ski-Doo Ex edition 550F 2006 Ski-Doo Freestyle 300F 2006 Ski-Doo MXZ 380F 2006 Ski-Doo MXZ 550F 2006 Ski-Doo MXZ 550X 2006 Ski-Doo Summit 550F 2006 Ski-Doo Tundra 300F
产品单重	145克			
检测程序	315 三相			
电线插头	20CM			
内盒尺寸	12*9.5*6CM			
外箱尺寸	49.5*25.5*30.5CM			
输出电压	14.5±0.5V			
一箱只数	100			
铝壳尺寸				
重要说明				
产品编号	R2020.4		 1正极 2检测 3交流 4交流 5负极	SKI-DOO SKANDIC 500 600 2002
产品单重	150克			
检测程序	215			
电线插头	15 黑线20CM			
内盒尺寸	12*9.5*6CM			
外箱尺寸	49.5*25.5*30.5CM			
输出电压	14.5±0.5V			
一箱只数	100			
铝壳尺寸				
重要说明	参考 R2020.9			

R2020.2.7

R2020.2.7

R2020.3

R2020.3

R2020.3.4





R2020.3.4

R2020.4



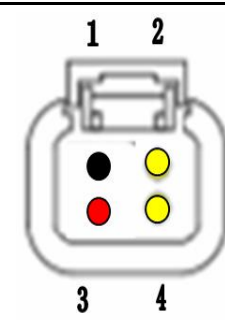
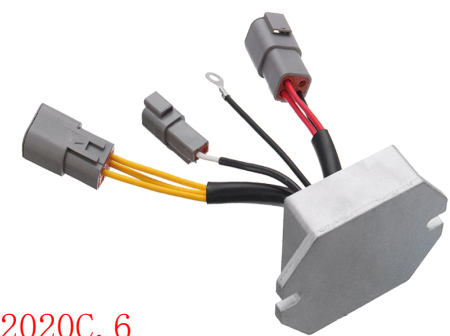
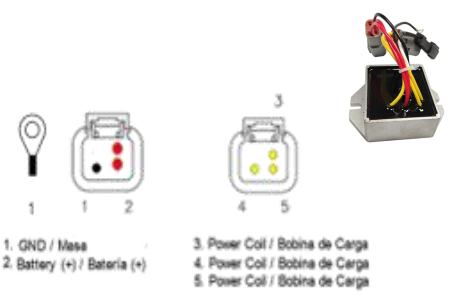

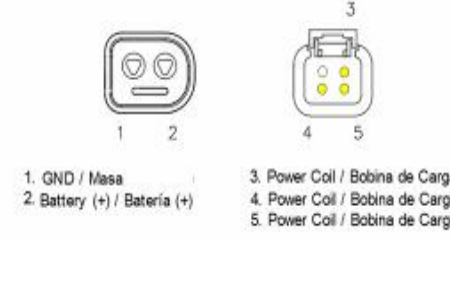

R2020.4

外壳接地 黑线不经过 整流器

产品资料1		实物主图	接口图	适用范围
产品编号	R2020.5			Ski-Doo Skandic 600 WT, 2001-2002 OEM #: 515-1755-46, 410-9113-00, 515-1639-00, 515-1638-00 515175216 515175491
产品单重	135克			
检测程序	215 不确定 同2020.2.3			
电线插头	25CM			
内盒尺寸	12*9.5*6CM			
外箱尺寸	49.5*25.5*30.5CM			
输出电压	14.5±0.5V			
一箱只数	100			
铝壳尺寸				
重要说明				
产品编号	R2020.9			515163900 515175546 410918400 420866080 410911300 410909000 410910300 410910700
产品单重	160			
检测程序	(=2020.4)			
电线插头	15 黑线20CM			
内盒尺寸	12*9.5*6CM			
外箱尺寸	49.5*25.5*30.5CM			
输出电压	14.5±0.5V			
一箱只数	100			
铝壳尺寸				
重要说明				
产品编号	R2020.10			Ski-Doo Replaces 515163900 515175546
产品单重				
检测程序	215			
电线插头	25 CM			
内盒尺寸	12*9.5*6CM			
外箱尺寸	49.5*25.5*30.5CM			
输出电压	14.5±0.5V			
一箱只数	100			
铝壳尺寸				
重要说明				
产品编号	R2020.11			Golf Cart 16V-18V to 12V, 15 am Voltage Reducer, Club Car rece nt 08.5+ 8V 410911300 410909000 410910300 410910700
产品单重				
检测程序				
电线插头				
内盒尺寸	12*9.5*6CM			
外箱尺寸	49.5*25.5*30.5CM			
输出电压	14.5±0.5V			
一箱只数	100			
铝壳尺寸				
重要说明				

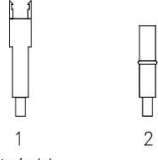
产品资料1		实物主图	接口图	适用范围
产品编号	R2020C. 3		 <p>1. 负极 (-) 2. 交流 AC 3. 正极 (+) 4. 交流 AC</p>	12V REGULATOR FITS SKI-DOO LEGEND 380 500 MX Z 380 550 515-175-655 515175655 515176189
产品单重	160克			
检测程序	215			
电线插头	15CM			
内盒尺寸	12*9.5*6CM			
外箱尺寸	49.5*25.5*30.5CM			
输出电压	14.5±0.5V			
一箱只数	50			
铝壳尺寸				
重要说明				
产品编号	R2020C. 6		 <p>1. GND / Masa 2. Battery (+) / Bateria (+) 3. Power Coil / Bobina de Carga 4. Power Coil / Bobina de Carga 5. Power Coil / Bobina de Carga</p>	515175717, 515176023 & 515176243 2003 Ski-Doo Grand Touring 800 SE SDI 2003 Ski-Doo Legend 800 SE SDI 2004 Ski-Doo GSX 600HO SDI 2004 Ski-Doo Legend 600HO GT SDI 2004 Ski-Doo Legend 600HO SDI 2004 Ski-Doo Legend 800 GT SDI 2004 Ski-Doo Legend 800 SDI 2004 Ski-Doo MXZ 600HO SDI 2005 Ski-Doo Ex edition 600HO SDI 2005 Ski-Doo GSX 600HO SDI
产品单重	175克			
检测程序	QF2101 新款 同2101.8板			
电线插头	10 15CM			
内盒尺寸	12*9.5*6CM			
外箱尺寸	49.5*25.5*30.5CM			
输出电压	14.5±0.5V			
一箱只数	100			
铝壳尺寸				
重要说明				
产品编号	R2020C. 7			Ski-doo Skandic 440 LT Carb F/C -- 2001-2004 Lynx est -- 2001-2004 Ski-doo Grand Touring 700 Carb L/C -- 2002 Ski-doo Grand Touring 800 Carb L/C -- 2002 Ski-doo Grand Touring 600 Carb L/C -- 2002 Ski-doo Legend 700 Carb L/C -- 2002 Ski-doo Grand Touring S ort 500 Carb
产品单重	308.3克			
检测程序	QF2101 新款 同2101.8板			
电线插头	10 15CM			
内盒尺寸	12*9.5*6CM			
外箱尺寸	49.5*25.5*30.5CM			
输出电压	14.5±0.5V			
一箱只数	100			
铝壳尺寸				
重要说明	三相磁电机 绿线是交流输入			
产品编号	R2020C. 8		 <p>1. GND / Masa 2. Battery (+) / Bateria (+) 3. Power Coil / Bobina de Carga 4. Power Coil / Bobina de Carga 5. Power Coil / Bobina de Carga</p>	Buell 1125 R -- 2008-2010 34407020 Buell 1125 CR -- 2009-2010 RM30603-R00 RM Stator Y0302.1AMC Buell
产品单重				
检测程序	M325			
电线插头	所有1.5 X 25CM			
内盒尺寸	12*9.5*6CM			
外箱尺寸	49.5*25.5*30.5CM			
输出电压	14.5±0.5V			
一箱只数	100			
铝壳尺寸				
重要说明				

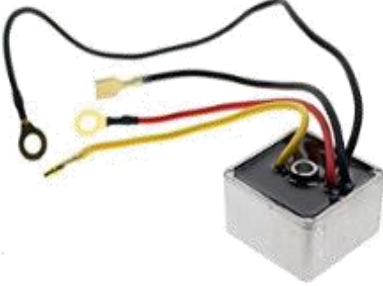
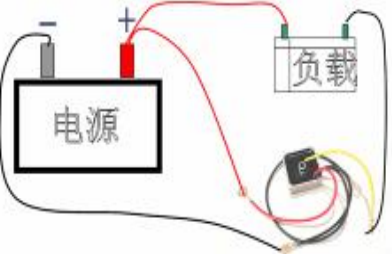
产品资料1		实物主图	接口图	适用范围
产品编号	R2020C.10			1056cc Arctic Cat Tz1 LXR Ltd 0630-255 Arctic Cat Snowmobile Re lace 0630-255, 0630-288
产品单重	300克净重			
检测程序	M325			
电线插头	所有1.5 X 20CM			
内盒尺寸	12*9.5*6CM			
外箱尺寸	49.5*25.5*30.5CM			
输出电压	14.5±0.5V			
一箱只数	100			
铝壳尺寸				
重要说明				
产品编号	R2020C.10H			12V 1056cc Arctic Cat XF1100 Turbo LXR 12 13 230-22175 0630-255 0630-288
产品单重	300克净重			
检测程序	M325			
电线插头	所有1.5 X 10 15CM			
内盒尺寸	12*9.5*6CM			
外箱尺寸	49.5*25.5*30.5CM			
输出电压	14.5±0.5V			
一箱只数	100			
铝壳尺寸				
重要说明				
产品编号	R2020C.11			2004 Bombardier 650 Quest XT #10 Voltage Regulator Rectifier 710000100, 710000019, 710000449 Can-Am Traxter Max XT 500 1999-2005 710000100 Notes Year Make Mo l Submo l 2004 Bombardier Quest 650 4X4 2004 Bombardier Quest 650 4x4 XT 2003 Bombardier Quest 650 4X4 2003 Bombardier Quest 650 4x4 XT 2002 Bombardier Quest 650 4X4
产品单重	283克净重			
检测程序	M325			
电线插头	所有1.5 X 25CM			
内盒尺寸	12*9.5*6CM			
外箱尺寸	49.5*25.5*30.5CM			
输出电压	14.5±0.5V			
一箱只数	100			
铝壳尺寸				
重要说明				
产品编号	R2020C.12			SKI-D00 515175461 515175214 515170600 515175214 515170600 515175461
产品单重				
检测程序	M325 绿线是交流输入线			
电线插头	15 25CM			
内盒尺寸	12*9.5*6CM			
外箱尺寸	49.5*25.5*30.5CM			
输出电压	14.5±0.5V			
一箱只数	100			
铝壳尺寸				
重要说明				

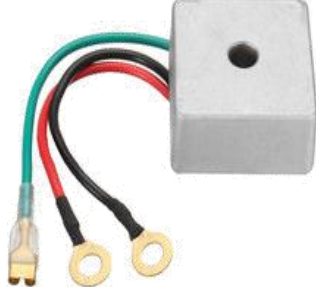
产品资料1		实物主图	接口图	适用范围
产品编号	R2020A.1			Briggs Stratton - Tri - Circuit 691188 Briggs Stratton - 5 / 9 Am Regulated 794360 Briggs Stratton - 491546
产品单重				
检测程序	直流108			
电线插头	15CM			
内盒尺寸	100*85*30MM			
外箱尺寸	49.5*25.5*30.5CM			
输出电压	8±0.5V			
一箱只数	100			
铝壳尺寸				
重要说明				
产品编号	R2020A.1.1		 <p>1. Battery (+) / Bateria (+) 2. Power Coil / Bobina de Carga</p> <p>Case/ Carcasa: GND/ Masa</p> 	Briggs Stratton - Tri - Circuit 691188 Briggs Stratton - 5 / 9 Am Regulated 794360 Briggs Stratton - 491546
产品单重				
检测程序	直流108 2326			
电线插头	15CM			
内盒尺寸	100*85*30MM			
外箱尺寸	49.5*25.5*30.5CM			
输出电压	12±0.5V 8A			
一箱只数	100			
铝壳尺寸				
重要说明				
产品编号	R2020A.1.2			1015777, 1027112-01, 102711201, CO 74510-85, 74510-85A, 74510-96 高尔夫球车整流器 2014 Club Car Carryall 1500 2WD Fleet Gas 2014 Club Car Carryall 300 Turf Fleet Gas 2014 Club Car Carryall 500 Turf Fleet Gas 2014 Club Car Carryall 550 Turf Fleet Gas
产品单重	100克			
检测程序	108			
电线插头	1530CM			
内盒尺寸	100*85*30MM			
外箱尺寸	49.5*25.5*30.5CM			
输出电压	8±0.5V			
一箱只数	100			
铝壳尺寸				
重要说明				
产品编号	R2020A.1.3			27739G01 高尔夫球车整流器 SKU 6355 Club Car DS Gas Golf Cart 1992'-2007' Voltage Regulator 1027112-01, 1015777 E-Z GO Golf Cart Voltage Regulator OE # 27739G01 replacement - E IGC111 EL11-071 27739-G01, 27739G01 74510-85A, 74510-96
产品单重	100克			
检测程序	108			
电线插头	15CM			
内盒尺寸	100*85*30MM			
外箱尺寸	49.5*25.5*30.5CM			
输出电压	8±0.5V			
一箱只数	100			
铝壳尺寸				
重要说明				

产品资料1		实物主图	接口图	适用范围
产品编号	R2020A. 1. 4			SKU 73297 高尔夫球车整流器 1025159-01, 102515901, 1028033-01, 102803301 Club Car Voltage Regulator reci nt 2004 U # 102803301 Genuine OEM Club Car RECE NT Golf Cart Voltage Regulator # 1025159-01 NEW VOLTAGE REGULATOR CLUB CAR RECE NT 4-CYCLE GAS GOLF CART 12VOLT 1025159-01
产品单重	100克			
检测程序	108			
电线插头	15CM			
内盒尺寸	100*85*30MM			
外箱尺寸	49.5*25.5*30.5CM			
输出电压	8±0.5V			
一箱只数	100			
铝壳尺寸				
重要说明				
产品编号	R2020A. 1. 5		 <p>1. GND/ Masa 3. Power Coil / Bobina de Carga 2. Battery (+) / Bateria (+) 4. Power Coil / Bobina de Carga</p>	Briggs Stratton-Quad Circuit397809
产品单重				
检测程序	208 2321			
电线插头	15CM			
内盒尺寸	100*85*30MM			
外箱尺寸	49.5*25.5*30.5CM			
输出电压	14.5±0.5V 12安培			
一箱只数	100			
铝壳尺寸				
重要说明				
产品编号	R2020A. 1. 5A		 <p>1. Power Coil / Bobina de Carga 3. By-Pass / Derivación 2. By-Pass / Derivación 4. Battery (+) / Bateria (+) Case/ Carcasa: GND/ Masa</p>	Briggs Stratton-Dual Circuit Alternator790292
产品单重				
检测程序	208 2327			
电线插头	15CM			
内盒尺寸	100*85*30MM			
外箱尺寸	49.5*25.5*30.5CM			
输出电压	14.5±0.5V 12安培			
一箱只数	100			
铝壳尺寸				
重要说明				
产品编号	R2020A. 1. 6		 <p>1. Battery (+) / Bateria (+) (Red/ Rojo) 2. Power Coil / Bobina de Carga (Yellow/ Amarillo) 3. Power Coil / Bobina de Carga (Yellow/ Amarillo) 4. GND/ Masa</p>	Sea Doo Ex lorer 1993 1997 278000123 Sea Doo Ex lorer 2002 278000123 Sea Doo GTI 1996 278000123 Sea Doo GTS 1994 2001 278000123 Sea Doo HX 1996 1997 278000123 Sea Doo S 1996 1997 278000123 Sea Doo S eedster SK 1994 1997 278000123 Sea Doo S ortster 1995 1997 278000123
产品单重	净重80克			
检测程序	208 10149			
电线插头	15CM			
内盒尺寸	100*85*30MM			
外箱尺寸	49.5*25.5*30.5CM			
输出电压	14.5±0.5V 12安培			
一箱只数	100			
铝壳尺寸				
重要说明				

R2020A. 1. 4

R2020A. 1. 4

R2020A. 1. 5







R2020A. 1. 5

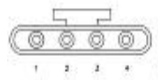

R2020A. 1. 5A



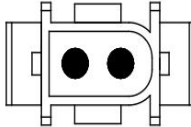

R2020A. 1. 5A

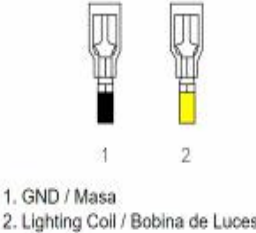

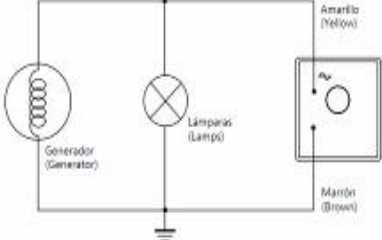
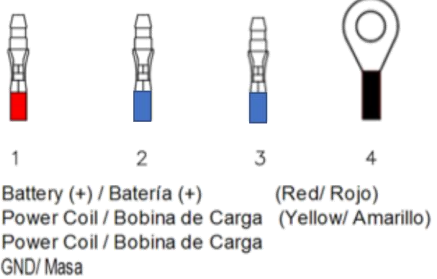
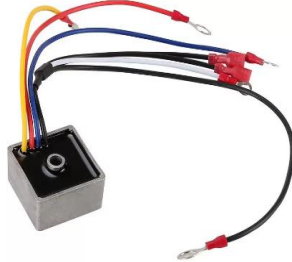

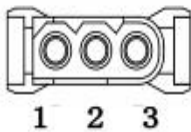

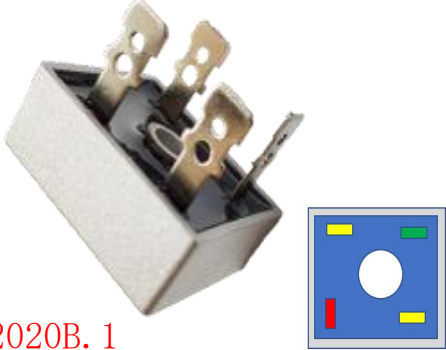
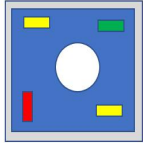
R2020A. 1. 6

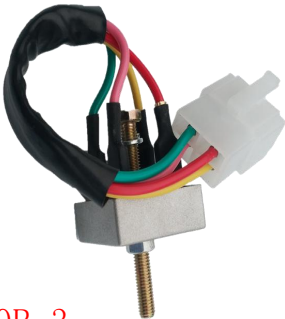

R2020A. 1. 6 黄红线接电瓶+和交流

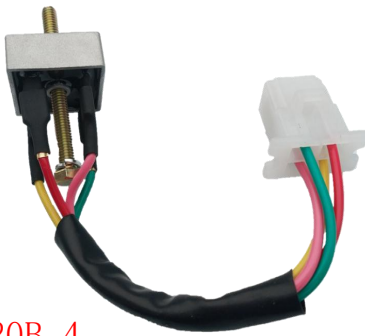
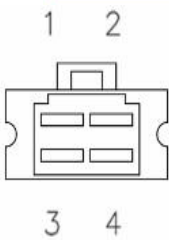
产品资料1		实物主图	接口图	适用范围
产品编号	R2020A. 1. 7		 <p>1. GND / Masa 2. Power Coil / Bobina de Carga 3. Power Coil / Bobina de Carga 4. Battery (+) / Bateria (+)</p>	Sea Doo Challenger 1998 278001239 Sea Doo Challenger 2000 278001239 Sea Doo GS 1997 2001 278001239 Sea Doo GTI 1997 2005 278001239 Sea Doo GTS 2001 278001239 Sea Doo Sportster 1800 1999 278001239 Sea Doo Sportster LT 2002 278001239
产品单重				
检测程序	208 10150			
电线插头	20CM			
内盒尺寸	100*85*30MM			
外箱尺寸	49.5*25.5*30.5CM			
输出电压	14.5±0.5V 12安培			
一箱只数	100			
铝壳尺寸				
重要说明				
产品编号	R2020A. 1. 8 (2051.3)			Arctic cat snowmobile 340 440 bearcat wi track 1995-2000, cheetah 1986- 1991, 440 Cougar 1991-1994, 500 Cougar 1985-1998, mountain cat 1985- 1998, El tigre 5000 6000 (87-89), 580 Ext 1993-1998, 440 580 600 700 800 wildcat 0232-020, 0630-001.
产品单重				
检测程序	直流108			
电线插头	15CM			
内盒尺寸	100*85*30MM			
外箱尺寸	49.5*25.5*30.5CM			
输出电压	14.5±0.5V			
一箱只数	100			
铝壳尺寸				
重要说明				
产品编号	R2020A. 1. 9			SKI DOO TUNDRA 300 R 1999-2005 RM22870-R00 OEM 515163800 410110600 Sea-Doo 515-163-800, 515163800 Ski-Doo 410-110-600, 410110600
产品单重				
检测程序				
电线插头	15CM			
内盒尺寸	100*85*30MM			
外箱尺寸	49.5*25.5*30.5CM			
输出电压	14.5±0.5V			
一箱只数	100			
铝壳尺寸				
重要说明				
产品编号	R2020A. 2		 <p>1. GND / Masa 2. Lighting Coil / Bobina de Luces</p>	2562 KTMDuke400199458011034500 KTMEGSM/Ö300199658011034500 KTMEGSM/Ö250199458011034500 KTMEGSMARZ/ÖHL125199658011034500 KTMEGSM/Ö360199658011034500 KTMEGSW 620 1994 199558011034500 KTMEGSM/Ö250199658011034500 KTMEXC620 1994 199558011034500 KTMEXCW 440199558011034500 KTMEXCM/Ö300 1996 1997 58011034500
产品单重				
检测程序	CA 开发中 2562			
电线插头	15CM			
内盒尺寸	100*85*30MM			
外箱尺寸	49.5*25.5*30.5CM			
输出电压	14.5±0.5V 12安培			
一箱只数	100			
铝壳尺寸				
重要说明				

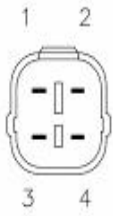

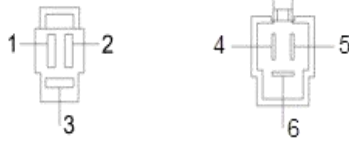
产品资料1		实物主图	接口图	适用范围
产品编号	R2020A.3			2572 KTM-54411034544 KTMEGSMARZ/ÖHL125199654411034000 KTMEGSM/Ö250199654411034000 KTMEGSM/Ö300199654411034000 KTMEGSM/Ö360199654411034000 KTMEGSM/Ö250199454411034000 KTMEXCM/Ö360199654411034000 KTMEXCMARZ/ÖHL125 1994 1996 54411034000 KTMEXCM/Ö250199654411034000 KTMEXC440199454411034000
产品单重				
检测程序	CA 开发中 2572			
电线插头	15CM			
内盒尺寸	100*85*30MM			
外箱尺寸	49.5*25.5*30.5CM			
输出电压	14.5±0.5V 20安培			
一箱只数	100			
铝壳尺寸				
重要说明				
产品编号	R2020A.4			2314 16A Universal 12V AC 150W
产品单重				
检测程序	CA 开发中2314			
电线插头	15CM			
内盒尺寸	100*85*30MM			
外箱尺寸	49.5*25.5*30.5CM			
输出电压	14.5±0.5V 16A			
一箱只数	100			
铝壳尺寸				
重要说明				
产品编号	R2020A.9			32800-95D10 Suzuki Outboard 25H 30H 75H 85H 2T 664-81970-61 Yamaha arsun owertec Outboard 6H - 40H 2/4T 664-81970-61 664-81970-62, 664-81970-60
产品单重				
检测程序	整流桥			
电线插头	15CM			
内盒尺寸	100*85*30MM			
外箱尺寸	49.5*25.5*30.5CM			
输出电压	14.5±0.5V 15安培			
一箱只数	100			
铝壳尺寸				
重要说明				
产品编号	R2020A.20			Dr. Acces Voltage Regulator CC G Trans 4+6 w/Key Start Fits Club Car Gas 2008-up Transporter 4+6 w/Key Start, Replace OEM# 1028034-01
产品单重				
检测程序	整流桥			
电线插头	15CM			
内盒尺寸	100*85*30MM			
外箱尺寸	49.5*25.5*30.5CM			
输出电压	14.5±0.5V 15安培			
一箱只数	100			
铝壳尺寸				
重要说明				

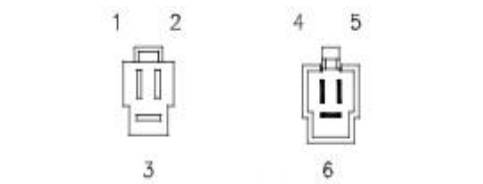
产品资料1		实物主图	接口图	适用范围
产品编号	R2020A.11		 <p>1 2 3</p> <p>1. Power Coil AC 2. Battery (+) 3. Power Coil AC 4. Enclosure grounding (-)</p>	691573 808297 190215 (20A)
产品单重				
检测程序	168F			
电线插头	15CM			
内盒尺寸	100*85*30MM			
外箱尺寸	49.5*25.5*30.5CM			
输出电压	14.5±0.5V 15安培			
一箱只数	100			
铝壳尺寸				
重要说明				
产品编号	R2020A.12			Briggs & Stratton 20 AM 697153, 808297 C verzió 808297, 691573
产品单重				
检测程序	168F			
电线插头	15CM			
内盒尺寸	100*85*30MM			
外箱尺寸	49.5*25.5*30.5CM			
输出电压	14.5±0.5V 15安培			
一箱只数	100			
铝壳尺寸				
重要说明				
产品编号	R2020B.1			Club Car高尔夫球车整流器35A 1022735-01
产品单重				
检测程序	16.7克净重			
电线插头				
内盒尺寸	100*85*30MM			
外箱尺寸	49.5*25.5*30.5CM			
输出电压	14.5±0.5V			
一箱只数	100			
铝壳尺寸				
重要说明				
产品编号	R2020B.2		 <p>1 2 3 4</p> <p>1. Battery (+) / Bateria (+) (Red/ Rojo) 2. Power Coil / Bobina de Carga (Yellow/ Amarillo) 3. Power Coil / Bobina de Carga 4. GND/ Masa</p>	31700-033-000 Heavy Duty Honda Rectifier Trail 90 CT 90 1968-1975 31700-102-701 K1 K2 K3 K4
产品单重	39.4			
检测程序				
电线插头	20CM 小线			
内盒尺寸	100*85*30MM			
外箱尺寸	49.5*25.5*30.5CM			
输出电压	14.5±0.5V			
一箱只数	100			
铝壳尺寸				
重要说明				

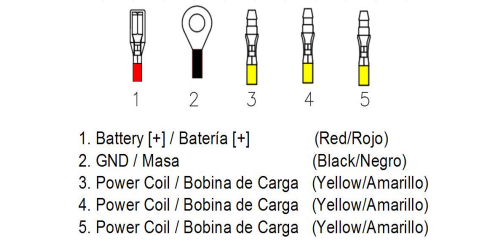
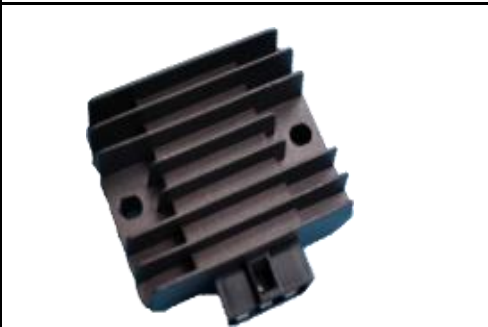
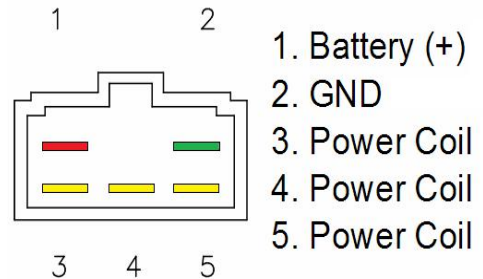
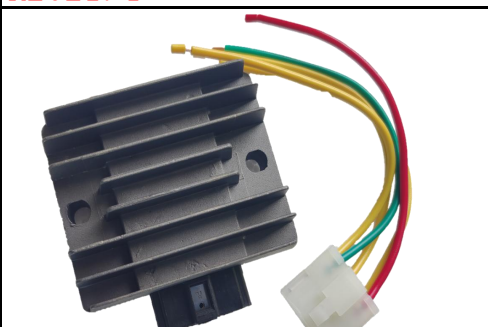
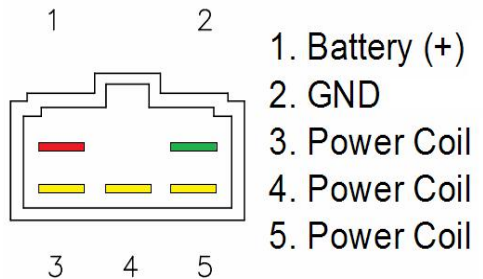
产品资料1		实物主图	接口图	适用范围
产品编号	R2020B.3		 <ol style="list-style-type: none"> 1. Battery (+) 2. GND 3. Power Coil 4. Power Coil 	Honda CT 90 CB CL XL 100 125 singles 31700-102-731 Quality U GRA erformance Rectifier Honda CB350F CB400F CT90 100 125 175 350
产品单重	42			
检测程序				
电线插头	20CM 小线			
内盒尺寸	100*85*30MM			
外箱尺寸	49.5*25.5*30.5CM			
输出电压	14.5±0.5V			
一箱只数	100			
铝壳尺寸				
重要说明				
产品编号	R2020B.4		 <ol style="list-style-type: none"> 1. Battery (+) 2. GND 3. Power Coil 4. Power Coil 	31700-455-671 31700-292-008 Honda MT 250 CB CL 350 450 360 XL 175
产品单重	42			
检测程序				
电线插头	20CM 小线			
内盒尺寸	100*85*30MM			
外箱尺寸	49.5*25.5*30.5CM			
输出电压	14.5±0.5V			
一箱只数	100			
铝壳尺寸				
重要说明				
产品编号	R2021.0		 <ol style="list-style-type: none"> 1. GND / Masa 2. Power Coil / Bobina de Carga 3. Power Coil / Bobina de Carga 4. Battery (+) / Bateria (+) 	Reem lazo Shin ngen SH712AB Yamaha YFZ 450 2012 2013 1 D- 81960-00-00 Yamaha YFZ 450 2004 2009 5TG-81960- 00-00
产品单重	净重158克			
检测程序	215 2406			
电线插头	25CM			
内盒尺寸	12*9.5*6CM			
外箱尺寸	49.5*25.5*30.5CM			
输出电压	14.5±0.5V 12安培			
一箱只数	100			
铝壳尺寸				
重要说明				
产品编号	R2021.1		 <ol style="list-style-type: none"> 1. AMARILLO / YELLOW : Generador / AC Generator 2. AMARILLO / YELLOW : Generador / AC Generator 3. AMARILLO / YELLOW : Generador / AC Generator 4. ROJO-BLANCO / RED-WHITE : Luces (+) / Lights (+) 5. ROJO / RED : Bateria (+) / Battery (+) 6. VERDE / GREEN : GND / Masa 	产品编号2021.1 单重/克 一箱只数 所属 类别: 三相全波整流器 输出电压 14.5+—0.5V 最大调节 2021.1// A lication: Lexmoto XTR S 125 KS125-24 2 block connector CBT125
产品单重				
检测程序	315			
电线插头	20CM			
内盒尺寸	12*9.5*6CM			
外箱尺寸	49.5*25.5*30.5CM			
输出电压	14.5±0.5V			
一箱只数	100			
铝壳尺寸				
重要说明				

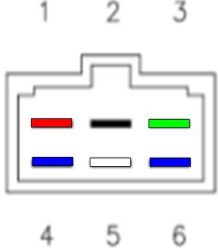
产品资料1		实物主图	接口图	适用范围
产品编号	R2021.2		 <p>1. Ignition Switch/ Sensor 2. Battery (+) / Bateria (+) 3. GND / Masa</p> <p>4. Power Coil / Bobina de Carga 5. Power Coil / Bobina de Carga 6. Power Coil / Bobina de Carga</p>	新大洲本田SDH150-F CBF150-SF/战神
产品单重				
检测程序	315			
电线插头	25CM			
内盒尺寸	12*9.5*6CM			
外箱尺寸	49.5*25.5*30.5CM			
输出电压	14.5±0.5V			
一箱只数	100			
铝壳尺寸				
重要说明				
产品编号	R2021.3		 <p>1. Battery (+) / Bateria (+) (Red/Rojo) 2. GND / Masa (Black/Negro) 3. Power Coil / Bobina de Carga (Yellow/Amarillo) 4. Power Coil / Bobina de Carga (Yellow/Amarillo) 5. Power Coil / Bobina de Carga (Yellow/Amarillo)</p>	新大洲本田SDH150-F CBF150-SF/战神 铃木4000
产品单重	净重157克			
检测程序	315			
电线插头	25CM			
内盒尺寸	12*9.5*6CM			
外箱尺寸	49.5*25.5*30.5CM			
输出电压	14.5±0.5V			
一箱只数	100			
铝壳尺寸				
重要说明				
产品编号	R2021.4		 <p>1. Battery (+) 2. GND 3. Power Coil 4. Power Coil 5. Power Coil</p>	HONDA CBT125
产品单重				
检测程序	315			
电线插头	5针插头			
内盒尺寸	100*85*30MM			
外箱尺寸	49.5*25.5*30.5CM			
输出电压	14.5±0.5V			
一箱只数	100			
铝壳尺寸				
重要说明				
产品编号	R2021.4A		 <p>1. Battery (+) 2. GND 3. Power Coil 4. Power Coil 5. Power Coil</p> <p>六针只用到5针</p>	Honda Small Engine HT3813 HT3810 H4013 HT4213 H4514H H4518H H5013 RT5000 Lawn Tractor 31600-890-951 31600- ZE2-861 6 ins New Z200
产品单重				
检测程序	315			
电线插头	6插只用5针+对插带线长度15CM			
内盒尺寸	100*85*30MM			
外箱尺寸	49.5*25.5*30.5CM			
输出电压	14.5±0.5V 20安培			
一箱只数	100			
铝壳尺寸				
重要说明				

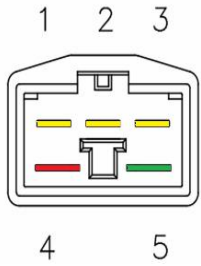

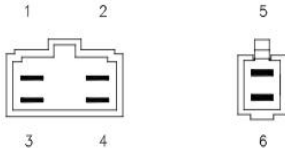
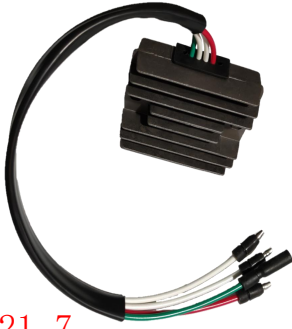
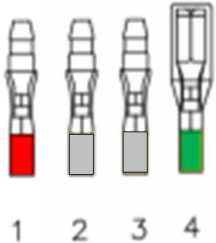
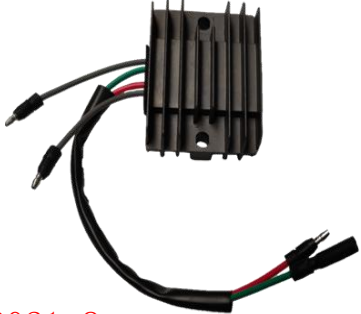
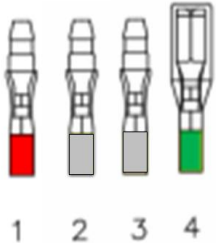



产品资料1		实物主图	接口图	适用范围
产品编号	R2021.4B		 <ol style="list-style-type: none"> 1. Battery (+) / Bateria (+) 2. Ignition Switch / Sensor 3. GND / Masa 4. Power Coil / Bobina de Carga 5. Power Coil / Bobina de Carga 	HONDA CBTHonda H 5013 A2/AC2 A4/AC4 31600-890-951 / SH547-12 Honda HT 3810 Lawn Tractor 31600-890-951 SH547-12 Honda HT 3813 Lawn Tractor 31600-890-951 SH547-12 Honda HT 4213 Lawn Tractor 31600-890-951 SH547-12 Honda RT 5000 A 31600-890-951 SH547-12 31600-ZE2-861 125
产品单重				
检测程序	215 2320			
电线插头	5针插头			
内盒尺寸	100*85*30MM			
外箱尺寸	49.5*25.5*30.5CM			
输出电压	14.5±0.5V 20安培			
一箱只数	100			
铝壳尺寸				
重要说明	5针插头			
产品编号	R2021.4C		 <ol style="list-style-type: none"> 1. Battery (+) 2. Ignition Switch 3. GND 4. Power Coil 5. Charge Lamp 6. Power Coil 	HONDA Traktor HT3810 HT3813 H4013 H4514 H4518 HT4213 H5013 HT5013 RT500
产品单重	净重 140克			
检测程序	215 2320			
电线插头	6针插头			
内盒尺寸	100*85*30MM			
外箱尺寸	49.5*25.5*30.5CM			
输出电压	14.5±0.5V 20安培			
一箱只数	100			
铝壳尺寸				
重要说明	6针插头			
产品编号	R2021.5		 <ol style="list-style-type: none"> 1. Power Coil 2. Power Coil 3. Power Coil 4. Battery (+) 5. GND 	iaggio 2944585
产品单重				
检测程序	315			
电线插头	五针插头			
内盒尺寸	100*85*30MM			
外箱尺寸	49.5*25.5*30.5CM			
输出电压	14.5±0.5V			
一箱只数	100			
铝壳尺寸				
重要说明				
产品编号	R2021.5.1		 <ol style="list-style-type: none"> 1. Power Coil 2. Power Coil 3. Power Coil 4. Battery (+) 5. GND 	CBT
产品单重				
检测程序	315			
电线插头	五针插头			
内盒尺寸	100*85*30MM			
外箱尺寸	49.5*25.5*30.5CM			
输出电压	14.5±0.5V			
一箱只数	100			
铝壳尺寸				
重要说明				





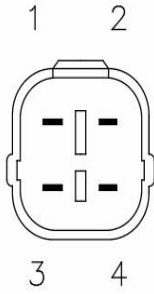

产品资料1		实物主图	接口图	适用范围
产品编号	R2021.5.2		 <p>1. Power Coil 2. Power Coil 3. Power Coil 4. Battery (+) 5. GND</p>	开关式大功率调压整流器15A适用于本田SCR110佳御110甲鱼
产品单重				
检测程序	M25			
电线插头	五针插头 20CM			
内盒尺寸	12*9.5*6CM			
外箱尺寸	49.5*25.5*30.5CM			
输出电压	14.5±0.5V 15安培			
一箱只数	100			
铝壳尺寸				
重要说明				
产品编号	R2021.6		 <p>1. Battery (+) / Batería (+) 2. GND / Masa 3. Power Coil / Bobina de Carga 4. Power Coil / Bobina de Carga 5. Battery (+) / Batería (+) 6. GND / Masa</p>	JOHN DEERE Cortadora cés ed AM109462 Kawasaki Cortadora cés ed 21066-2071 Reem lazo Shin ngen SH637-12
产品单重	240克			
检测程序	215 2318			
电线插头	20CM			
内盒尺寸	12*9.5*6CM			
外箱尺寸	49.5*25.5*30.5CM			
输出电压	14.5±0.5V 20安培			
一箱只数	50			
铝壳尺寸				
重要说明				
产品编号	R2021.7		 <p>1. Battery (+) 2. Power Coil 3. Power Coil 4. GND</p>	Honda BF 15A / Year 2002 / 15' Shaft / BAAS-1700380 32100-ZW9-000, 32100-ZV4-650,
产品单重	250克			
检测程序	215 2318			
电线插头	25CM 4线 (红绿白白)			
内盒尺寸	12*9.5*6CM			
外箱尺寸	49.5*25.5*30.5CM			
输出电压	14.5±0.5V 20安培			
一箱只数	50			
铝壳尺寸				
重要说明				
产品编号	R2021.8		 <p>1. Battery (+) 2. Power Coil 3. Power Coil 4. GND</p>	1997 Honda 25 hp 31750-ZV7-003 31600-ZV4-661
产品单重	240克			
检测程序	215			
电线插头	12 25CM 4线 (红绿灰灰)			
内盒尺寸	12*9.5*6CM			
外箱尺寸	49.5*25.5*30.5CM			
输出电压	14.5±0.5V 20安培			
一箱只数	50			
铝壳尺寸				
重要说明				

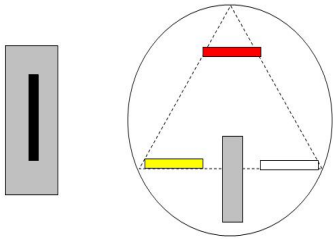

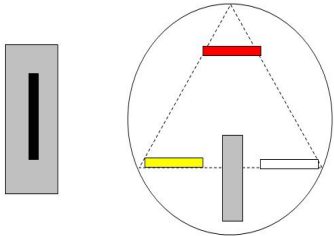

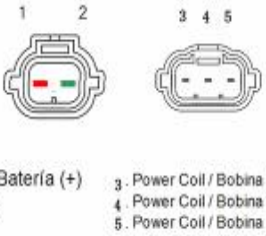
产品资料1		实物主图	接口图	适用范围
产品编号	R2021.9		 <p>1 2 3 4 5 6</p> <p>1. AC Power Coil 1是AC输出 2. AC Power Coil 3. AC Power Coil 4. Battery (+) 5. Battery (+) 6. Battery (-)</p>	Honda 25 30 HP 31750-ZW2-F93 SH598C-12 Honda 50 HP 4 Stroke Rectifier And Regulator PN 31600-ZV5-003 Fits Pre 1997-2006
产品单重	210克			
检测程序	QF2101 新			
电线插头	负极15 白线25黄线和黑白线45CM			
内盒尺寸	12*9.5*6CM			
外箱尺寸	49.5*25.5*30.5CM			
输出电压	14.5±0.5V			
一箱只数	50	R2021.9	R2021.9	
铝壳尺寸	1号线应该是交流输出			TRIUMPH REGULATOR / RECTIFIER, THREE PHASE, 12 VOLT ; TRIUMPH, BSA, NORTON Triumph Podtronics 200 Watt 1966-78 T120 Tr6 T100 T140 Tr7
重要说明	黑白线是指示灯线 ,白线正 黑线负			
产品编号	R2021.10			
产品单重				
检测程序	215			
电线插头	30CM			
内盒尺寸	12*9.5*6CM			
外箱尺寸	49.5*25.5*30.5CM			
输出电压	14.5±0.5V	R2021.10	R2021.10	
一箱只数	50			Honda 125cc CM CMX 125
铝壳尺寸				
重要说明				
产品编号	R2021.11			
产品单重				
检测程序	315			
电线插头				
内盒尺寸	12*9.5*6CM			
外箱尺寸	49.5*25.5*30.5CM			
输出电压	14.5±0.5V	R2021.11	R2021.11	
一箱只数	50		 <p>1 2</p> <p>3 4 5</p> <p>1. Battery (+) / Bateria (+) 2. GND / Masa 3. Power Coil / Bobina de Carga 4. Power Coil / Bobina de Carga 5. Power Coil / Bobina de Carga</p> <p>低电压 315板</p>	产品编号2021A.0 单重/克 Re laces Kawasaki art 21066-0010 & 21066-0039 Fits the following: 2017 MULE SX™ 2017 MULE SX™ 4x4 2017 MULE SX™ 4x4 SE 2017 MULE SX™ 4x4 XC 2017 MULE SX™ 4x4 XC CAMO 2017 MULE SX™ 4x4 XC SE 2016 MULE™ 600
铝壳尺寸				
重要说明				
产品编号	R2021A.0			
产品单重	120			
检测程序	315低电压版			
电线插头	6插只用5针			
内盒尺寸	100*85*30MM			
外箱尺寸	49.5*25.5*30.5CM	R2021A.0	R2021A.0	
输出电压	14.5±0.5V			
一箱只数	100			
铝壳尺寸				
重要说明				

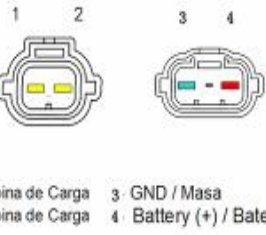
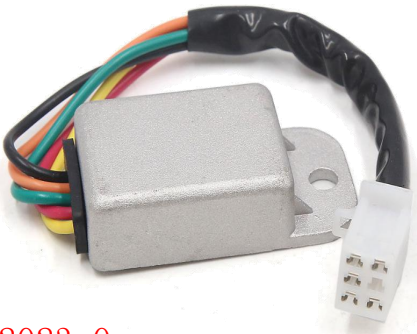





产品资料1		实物主图	接口图	适用范围
产品编号	R2021A.1			产品编号2021A.1 单重/克 一箱只数 所属类别: : 三相全波整流器 输出电压 14.5+—0.5V 最大调节 A lication: 嘉陵250大地鹰王DD250超光CA250硅整流充电器稳压器整流器5线
产品单重				
检测程序	315			
电线插头	25CM			
内盒尺寸	12*9.5*6CM			
外箱尺寸	49.5*25.5*30.5CM			
输出电压	14.5±0.5V			
一箱只数	100			
铝壳尺寸				
重要说明				
产品编号	R2021A.2			嘉陵本田太子 CM125整流器 双缸太子充电器 稳压器 5线
产品单重				
检测程序	315			
电线插头	25CM			
内盒尺寸	12*9.5*6CM			
外箱尺寸	49.5*25.5*30.5CM			
输出电压	14.5±0.5V			
一箱只数	100			
铝壳尺寸				
重要说明				
产品编号	R2021A.3			踏板摩托车配件稳压整流器公主GY6125四线整流器调压器硅整流
产品单重				
检测程序	315			
电线插头	25CM			
内盒尺寸	12*9.5*6CM			
外箱尺寸	49.5*25.5*30.5CM			
输出电压	14.5±0.5V			
一箱只数	100			
铝壳尺寸				
重要说明				
产品编号	R2021A.4			YAMAHA arsun Outboard 6AH-81960 15H 20H F15 F20 4T
产品单重				
检测程序				
电线插头	20 25CM			
内盒尺寸	12*9.5*6CM			
外箱尺寸	49.5*25.5*30.5CM			
输出电压	14.5±0.5V			
一箱只数	100			
铝壳尺寸				
重要说明				



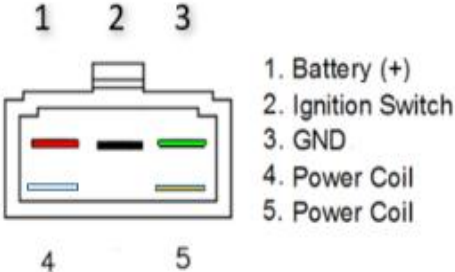



产品资料1		实物主图	接口图	适用范围
产品编号	R2021A. 5		 <p>1. Power Coil / Bobina de 2. Power Coil / Bobina de 3. Power Coil / Bobina de 4. Ignition Switch/ Sensor 5. Battery (+) / Bateria (+) 6. GND / Masa</p>	适用于GY6 50cc 125cc 150cc 200cc 250cc
产品单重	净重170克			
检测程序	315低电压版			
电线插头	1平方 20CM			
内盒尺寸	100*85*30MM			
外箱尺寸	49.5*25.5*30.5CM			
输出电压	14.5±0.5V			
一箱只数	100			
铝壳尺寸				
重要说明				
产品编号	R2021A. 10			Honda CBF125 CBF150 CBF 150 KTS KTT 31600-KPN-A01
产品单重	120			
检测程序	315低电压版			
电线插头	6插只用5针			
内盒尺寸	100*85*30MM			
外箱尺寸	49.5*25.5*30.5CM			
输出电压	14.5±0.5V			
一箱只数	100			
铝壳尺寸				
重要说明				
产品编号	R2021A. 11			YANMAR L100 DIESEL ENGINE AND CHINESE 10HP 186 DIESEL ENGINES. 62MM/2.5INCH HOLE CENTER TO CENTER. 3 WIRES IN TWO CONNECTORS. INPUT VOLTAGE: 15-55V. OUTPUT VOLTAGE: 13.8V +/-0.3V
产品单重	120			
检测程序	315低电压版			
电线插头	6插只用5针			
内盒尺寸	100*85*30MM			
外箱尺寸	49.5*25.5*30.5CM			
输出电压	14.5±0.5V			
一箱只数	100			
铝壳尺寸				
重要说明				
产品编号	R2021A. 12			YANMAR L70 L75 L90 DIESEL Motor 62mm/2.5inch hole to hole on center 3 wires in two connector. Input Voltage: 15-55V
产品单重	120			
检测程序	315低电压版			
电线插头	6插只用5针			
内盒尺寸	100*85*30MM			
外箱尺寸	49.5*25.5*30.5CM			
输出电压	14.5±0.5V			
一箱只数	100			
铝壳尺寸				
重要说明				



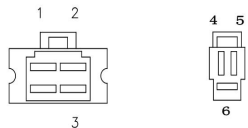

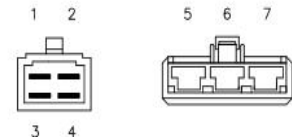

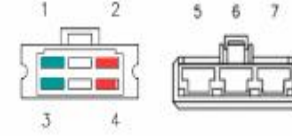
产品资料1		实物主图	接口图	适用范围
产品编号	R2021B.1		 <p>1. Power Coil / Bobina de Carga 2. GND / Masa 3. Battery (+) / Bateria (+) 4. Power Coil / Bobina de Carga</p>	YAMAHA 天剑YBR 150 飞致150 YS125 150 JYM150 54B-H1960-00 2GS-H1960-00
产品单重	净重105克			
检测程序	215			
电线插头	4针插头			
内盒尺寸	12*9.5*6CM			
外箱尺寸	49.5*25.5*30.5CM			
输出电压	14.5±0.5V			
一箱只数	100			
铝壳尺寸				
重要说明				
产品编号	R2022.0		 <p>1. GND 绿线 2. Power Coil 白线 大灯 3. Power Coil 黄线 4. Battery (+) 红线</p>	YamahaYFZ450 2012 20131 D-81960-00-00 YamahaYFZ450 2004 20095TG-81960-00-00
产品单重	122			
检测程序	HS08半波 2406			
电线插头	15CM小线			
内盒尺寸	100*85*30MM			
外箱尺寸	49.5*25.5*30.5CM			
输出电压	14.5±0.5V 12安培			
一箱只数	100			
铝壳尺寸				
重要说明				
产品编号	R2022.1		 <p>1. Battery (+) 2. Power Coil</p>	Yamaha wr250f voltage regulator rectifier Yamaha WR426F WR426 Voltage Regulator Rectifier 2000 2001 WR250F 5GS-81910-50-00
产品单重				
检测程序	二极管			
电线插头	25CM小线			
内盒尺寸	100*85*30MM			
外箱尺寸	49.5*25.5*30.5CM			
输出电压	14.5±0.5V			
一箱只数	100			
铝壳尺寸				
重要说明				
产品编号	R2022.2			5TJ-81960-00-00, 5TJ-81960-01-00, 5TJ-81960-02-00, 5TJ-81960-80-00 SH712AA, SH712AC Yamaha WR250F 04-05, WR450F 04 5UM-81960-E0-00
产品单重	195			
检测程序	HS08半波 2406			
电线插头	35CM小线			
内盒尺寸	100*85*30MM			
外箱尺寸	49.5*25.5*30.5CM			
输出电压	14.5±0.5V			
一箱只数	100			
铝壳尺寸				
重要说明				

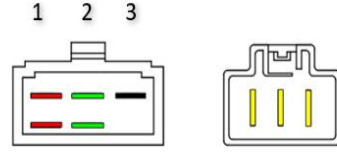

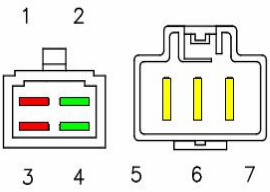

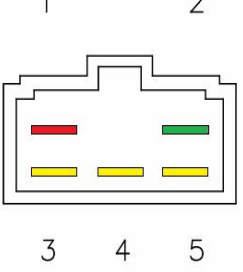

产品资料1		实物主图	接口图	适用范围
产品编号	R2022A. 2			Yamaha WR250F WR250 2007-2014 Yamaha WR450F WR450 2007-2012 12V Yamaha 5UM-81960-E0 WR250F WR250 07-14 WR450
产品单重	85克净重			
检测程序	HS08半波 2406			
电线插头	35CM小线			
内盒尺寸	100*85*30MM			
外箱尺寸	49.5*25.5*30.5CM			
输出电压	14.5±0.5V			
一箱只数	100			
铝壳尺寸				
重要说明				
产品编号	R2022B. 1		 <p>1. Battery (+) / Bateria (+) 2. GND / Masa</p> <p>3. Power Coil / Bobina de Carga 4. Power Coil / Bobina de Carga 5. Power Coil / Bobina de Carga</p>	2GB-81960-00-00: Yamaha YZ450F 2010-2017 Yamaha WR450F (WR450FH) 2012-2017 Yamaha 5UM-81960-E0
产品单重	克净重			
检测程序	308			
电线插头	15CM小线			
内盒尺寸	100*85*30MM			
外箱尺寸	49.5*25.5*30.5CM			
输出电压	14.5±0.5V			
一箱只数	100			
铝壳尺寸				
重要说明				
产品编号	R2022B. 2		 <p>1. Power Coil / Bobina de Carga 2. Power Coil / Bobina de Carga</p> <p>3. GND / Masa 4. Battery (+) / Bateria (+)</p>	Yamaha WR250F WR250 2007-2014 Yamaha WR450F WR450 2007-2012
产品单重	85克净重			
检测程序	215			
电线插头	35CM小线			
内盒尺寸	100*85*30MM			
外箱尺寸	49.5*25.5*30.5CM			
输出电压	14.5±0.5V			
一箱只数	100			
铝壳尺寸				
重要说明				
产品编号	R2023. 0		 <p>1. Power Coil / Bobina de Carga 2. Power Coil / Bobina de Carga 3. Battery (+) / Bateria (+) 4. GND / Masa 5. Ignition Switch / Sensor</p>	Honda XL R 200 de 1983 a 1984 31600-KG0-000 Honda XL R 500 1982 31600-MC4-000 Honda XL R 350 de 1984 a 1985 31400-KB9-008 Honda XL R 250 de 1984 a 1987 31400-KB9-008 Honda XL R 600 de 1983 a 1987 31600-KG0-000
产品单重	80			
检测程序	208 2525			
电线插头	15CM小线			
内盒尺寸	100*85*30MM			
外箱尺寸	49.5*25.5*30.5CM			
输出电压	14.5±0.5V 12安培			
一箱只数	100			
铝壳尺寸				
重要说明	白色铝壳 1号是橙色AC			

产品资料1		实物主图	接口图	适用范围
产品编号	R2023.1		 <ol style="list-style-type: none"> 1. Power Coil / Bobina de Carga 2. Power Coil / Bobina de Carga 3. Battery (+) / Bateria (+) 4. GND / Masa 5. Ignition Switch / Sensor 	Honda XL R 200 de 1983 a 1984 31600-KG0-000 Honda XL R 500 1982 31600-MC4-000 Honda XL R 350 de 1984 a 1985 31400-KB9-008 Honda XL R 250 de 1984 a 1987 31400-KB9-008 Honda XL R 600 de 1983 a 1987 31600-KG0-000
产品单重	80			
检测程序	208 2525			
电线插头	15CM小线			
内盒尺寸	100*85*30MM			
外箱尺寸	49.5*25.5*30.5CM			
输出电压	14.5±0.5V 12安培			
一箱只数	100			
铝壳尺寸				
重要说明	黑色铝壳 1号是橙色AC			
产品编号	R2023.2		 <ol style="list-style-type: none"> 1. GND 2. Power Coil 3. Power Coil 4. Battery (+) 5. GND 6. Battery (+) 	Suzuki RM125 RM250 32800-37E20 1996-2000
产品单重	净重85克			
检测程序	208			
电线插头	35CM小线			
内盒尺寸	100*85*30MM			
外箱尺寸	49.5*25.5*30.5CM			
输出电压	14.5±0.5V			
一箱只数	100			
铝壳尺寸				
重要说明				
产品编号	R2023.3			Kawasaki KX250 KX 250 21066-1123 99 01 02 03 04 KAWASAKI KX250 KX 250 125 SH542-12 VOLTAGE REGULATOR 21066-1116 Kawasaki KX250 kx125 KX 250 125 apr. SH542-12 21066-1123
产品单重				
检测程序	208			
电线插头	25CM小线			
内盒尺寸	100*85*30MM			
外箱尺寸	49.5*25.5*30.5CM			
输出电压	14.5±0.5V			
一箱只数	100			
铝壳尺寸				
重要说明				
产品编号	R2023.4			Kawasaki KX250 KX 250 21066-1123 99 01 02 03 04 KAWASAKI KX250 KX 250 125 SH542-12 VOLTAGE REGULATOR 21066-1116
产品单重				
检测程序	208			
电线插头	30CM小线			
内盒尺寸	100*85*30MM			
外箱尺寸	49.5*25.5*30.5CM			
输出电压	14.5±0.5V			
一箱只数	100			
铝壳尺寸				
重要说明				

产品资料1		实物主图	接口图	适用范围
产品编号	R2023.5			Honda 31600-459-910 Honda CT110 ostie Bikesc 6 v 1986-2003
产品单重				
检测程序	208			
电线插头	30CM小线			
内盒尺寸	100*85*30MM			
外箱尺寸	49.5*25.5*30.5CM			
输出电压	14.5±0.5V			
一箱只数	100			
铝壳尺寸				
重要说明				
产品编号	R2023.6			Minimum Charging Voltage: 14.5V +-0.5V Maximum Charging Current: 50A/500W O en Circuit Voltage: 15V Honda CR 125 R -- 2004 Honda CR 250 R -- 2002-2007 31600-KZ3-J41 SH542B-12 Honda XR 650 R7 2007 电容规格 35V 1000 μF
产品单重	200克			
检测程序	215			
电线插头	35CM小线 接电容线长15			
内盒尺寸	100*85*30MM			
外箱尺寸	49.5*25.5*30.5CM			
输出电压	14.5±0.5V			
一箱只数	100			
铝壳尺寸				
电容规格	35V1000 μF			
产品编号	R2023.7			Minimum Charging Voltage: 14.5V +-0.5V Maximum Charging Current: 50A/500W O en Circuit Voltage: 15V Honda CR 125 R -- 2004 Honda CR 250 R -- 2002-2007 31600-MBN-651 Honda 600 XR R (E04) 1988-2000 SH542B-12 电容规格 35V 1000 μF
产品单重				
检测程序	208			
电线插头	35CM小线 接电容线长15			
内盒尺寸	100*85*30MM			
外箱尺寸	49.5*25.5*30.5CM			
输出电压	14.5±0.5V			
一箱只数	100			
铝壳尺寸				
电容规格	35V1000 μF			
产品编号	R2024.1			Honda CB125F 2018 6,523 miles SH879AA (5206)
产品单重				
检测程序	M325			
电线插头				
内盒尺寸	12*9.5*6CM			
外箱尺寸	49.5*25.5*30.5CM			
输出电压	14.5±0.5V 35安培			
一箱只数	50			
铝壳尺寸				
电容规格				

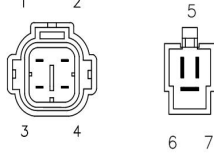

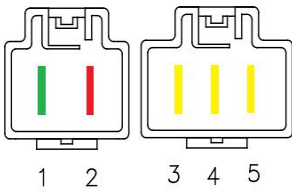
产品资料1		实物主图	接口图	适用范围
产品编号	R2025.0		 <p>1. Ignition Switch / Sensor 2. Battery (+) / Bateria (+) 3. GND / Masa</p> <p>4. Power Coil / Bobina de Carga 5. Power Coil / Bobina de Carga 6. Power Coil / Bobina de Carga</p>	2056 35A Honda CB SC Nighthawk 450 1982 1986 31600-MC9-740 Honda CB 400 1978 31600-413-008 Honda CB T Hawk 400 1980 1981 31600-413-008 Honda CB T Hawk 450 1982 31600-413-008 Honda CB T 250 1978 1979 31600-KV8-681 Honda CB S 250 1978 1985 31600-MC9-
产品单重	460克			
检测程序	M325 2056			
电线插头	25CM			
内盒尺寸	12*9.5*6CM			
外箱尺寸	49.5*25.5*30.5CM			
输出电压	14.5±0.5V 35安培			
一箱只数	50			
铝壳尺寸				
重要说明				
产品编号	R2025.1		 <p>1. Battery (+) / Bateria (+) 2. GND / Masa 3. Battery (+) / Bateria (+) 4. GND / Masa</p> <p>5. Power Coil / Bobina de Carga 6. Power Coil / Bobina de Carga 7. Power Coil / Bobina de Carga</p>	Aprilia Atlantic S rint 500 2005 2008 A 8127809 Aprilia Atlantic S rint 400 2005 2008 A 8127809 Aprilia Atlantic 125 2006 2008 A 8127809 Aprilia Atlantic 250 2006 2008 A 8127809 Aprilia Atlantic 500 2001 2004 A 8127809 Aprilia Scarabeo Light 500 2006
产品单重	514克			
检测程序	M325 2593			
电线插头	黄线1.5 X 60 和红绿灯线 25CM			
内盒尺寸	12*9.5*6CM			
外箱尺寸	49.5*25.5*30.5CM			
输出电压	14.5±0.5V MOSFET 35安培			
一箱只数	50			
铝壳尺寸				
重要说明	默认黑色4插, 有时用白色4插			
产品编号	R2025.1A		 <p>1. GND / Masa 2. Battery (+) / Bateria (+) 3. GND / Masa 4. Battery (+) / Bateria (+)</p> <p>5. Power Coil / Bobina de Carga 6. Power Coil / Bobina de Carga 7. Power Coil / Bobina de Carga</p>	Appia Beraka 125 Appia Brezza EURO 150 Appia Brezza CDI a bateria 150 Appia Brezza CDI a magneto 150 Appia City Plus 110 desde 2012 Appia Geremy 125 Appia Hardwing 200 desde 2011 Appia Leyenda 150 desde 2009 Appia Stronger 150 desde 2009 Cerro Link CE 110 Cerro Scratch R 200
产品单重	514克			
检测程序	M325 2593			
电线插头	黄线1.5 X 60 和红绿灯线 20CM			
内盒尺寸	12*9.5*6CM			
外箱尺寸	49.5*25.5*30.5CM			
输出电压	14.5±0.5V MOSFET 35安培			
一箱只数	50			
铝壳尺寸				
重要说明				
产品编号	R2025.2		 <p>1. Battery (+) / Bateria (+) 2. GND / Masa 3. Ignition Switch / Sensor 4. Battery (+) / Bateria (+)</p> <p>5. GND / Masa 6. Power Coil / Bobina de Carga 7. Power Coil / Bobina de Carga 8. Power Coil / Bobina de Carga</p>	2402 Honda CBR 954 Firebla 900 2002 2003 31600-MCJ-750 Reem lazo Shin ngen SH678-DA 2403 Honda - 31600-MBG-D00 Honda CBR 1100 1999 2000 31600-MAT-E01 Honda CBR XX Blackbird 1100 1999 2000 31600-MAT-E01 Reem lazo Shin ngen SH579C-12
产品单重	514克			
检测程序	M325 2402 2403			
电线插头	黄1.5 所有线长35CM			
内盒尺寸	12*9.5*6CM			
外箱尺寸	49.5*25.5*30.5CM			
输出电压	14.5±0.5V 35安培			
一箱只数	50			
铝壳尺寸				
重要说明				

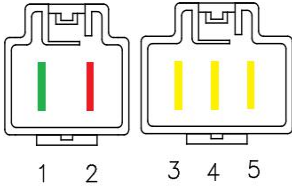



产品资料1		实物主图	接口图	适用范围
产品编号	R2025. 2. 1		 <p>1. Battery (+) 2. GND 3. Battery (+) 4. GND 5. Power Coil 6. Power Coil 7. Power Coil</p>	YHC060 HONDA CBR900RR CBR929RR 2000-2003 Honda CB919 CB 900 整流器
产品单重				
检测程序	M325			
电线插头	黄1.5 X 25CM			
内盒尺寸	12*9.5*6CM			
外箱尺寸	49.5*25.5*30.5CM			
输出电压	14.5±0.5V			
一箱只数	50	R2025. 2. 1	R2025. 2. 1	
铝壳尺寸			 <p>1. Battery (+) / Bateria (+) 2. GND / Masa 3. Ignition Switch / Sensor 4. Battery (+) / Bateria (+) 5. GND / Masa 6. Power Coil / Bobina de Carga 7. Power Coil / Bobina de Carga 8. Power Coil / Bobina de Carga</p>	2480 Honda VFR 800 2002 2003 31600-MCW-D01 Honda VFR 800 2004 2009 31600-MCW-D61 Honda VFR ABS 800 2004 2009 31600-MCW-D61 2473 Honda VFR FI 800 2000 2001 31600-MBG-D01 SH689A-12 Honda VFR FI 800 2000 2001 31600-
产品编号	R2025. 3			
产品单重	480克			
检测程序	M325 2473 2480			
电线插头	黄1.5 X 25CM 短线			
内盒尺寸	12*9.5*6CM			
外箱尺寸	49.5*25.5*30.5CM			
输出电压	14.5±0.5V 35安培			
一箱只数	50	R2025. 3	R2025. 3	
铝壳尺寸			 <p>1. Battery (+) / Bateria (+) 2. GND / Masa 3. Ignition Switch / Sensor 4. Battery (+) / Bateria (+) 5. GND / Masa 6. Power Coil / Bobina de Carga 7. Power Coil / Bobina de Carga 8. Power Coil / Bobina de Carga</p>	2402 Honda CBR 954 Firebla 900 2002 2003 31600-MCJ-750 Reem lazo Shin ngen SH678-DA 2403 Honda - 31600-MBG-D00 Honda CBR 1100 1999 2000 31600-MAT-E01 Honda CBR XX Blackbird 1100 1999 2000 31600-MAT-E01 Reem lazo Shin ngen SH579C-12
产品编号	R2025. 3. 1			
产品单重	580克			
检测程序	M325 2402 2403 2488			
电线插头	黄1.5 所有线长75CM 长线			
内盒尺寸	12*9.5*6CM			
外箱尺寸	49.5*25.5*30.5CM			
输出电压	14.5±0.5V 35安培			
一箱只数	50	R2025. 3. 1	R2025. 3. 1	
铝壳尺寸			 <p>1. Battery (+) 2. GND 3. Power Coil 4. Power Coil 5. Power Coil</p>	32800-33E10 32800-33E20 32800-33E00 32800-33E21 Suzuki GSX-R 600 750 1000 1300 VL 1500 DR 800 Suzuki GSX-R 600 01 - 03 Suzuki GSX-R 600 04 - 05 Suzuki GSX-R 750 96 - 97 Suzuki GSX-R 750 98 - 99 Suzuki GSX-R 750 00 - 03 Suzuki GSX-R 750 04 - 05 Suzuki DR 800 BIG 91 - 99
产品编号	R2025. 4			
产品单重	430克			
检测程序	M325			
电线插头	25CM			
内盒尺寸	12*9.5*6CM			
外箱尺寸	49.5*25.5*30.5CM			
输出电压	14.5±0.5V			
一箱只数	50	R2025. 4	R2025. 4	
铝壳尺寸				
重要说明				

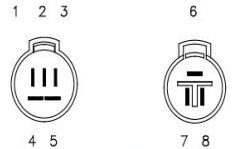



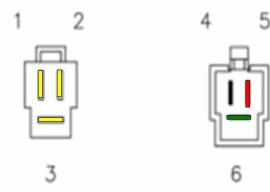

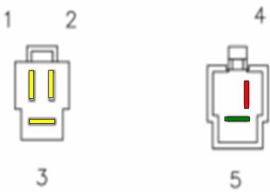
产品资料1		实物主图	接口图	适用范围
产品编号	R2025.5			32800-33E10 / 32800-33E20 32800-33E00 ATV 2006 Accurate Cycle Engineering Badger -- 1960 AJS Mo l 14 CS 1963 AJS Mo l 14S Sa hire S orts Single 1965 AJS Mo l 16 S ectre 1955 AJS Mo l 16 MS 1963 AJS Mo l 18 S 1956 ATS Mo l 20 Twin
产品单重	430克			
检测程序	M325			
电线插头	45CM			
内盒尺寸	12*9.5*6CM			
外箱尺寸	49.5*25.5*30.5CM			
输出电压	14.5±0.5V			
一箱只数	50			
铝壳尺寸				
重要说明				
产品编号	R2025.6		 <p>1. Battery (+) / Batería (+) 2. Battery (+) / Batería (+) 3. GND / Masa 4. GND / Masa 5. Power Coil / Bobina de Carga 6. Power Coil / Bobina de Carga 7. Power Coil / Bobina de Carga</p>	2008 SUZUKI GSXR GSX-R 750 K8 VOLTAGE REGULATOR RECTIFIER NEW 32800-02H00 32800-15H10 32800-21H00 32800-18H00 (06~09) GSXR 600 (06~09) GSXR 750 (07~08) GSXR 1000 (08~12) GSXR 1300 Hayabusa (08~09) GSX 650 F
产品单重	440克			
检测程序	M325			
电线插头	25CM			
内盒尺寸	12*9.5*6CM			
外箱尺寸	49.5*25.5*30.5CM			
输出电压	14.5±0.5V			
一箱只数	50			
铝壳尺寸				
重要说明				
产品编号	R2025.7		 <p>1. GND 2. Battery (+) 3. Power Coil 4. Power Coil 5. Power Coil</p>	2632 MOSFET 35A AP rilia - 641533 AP rilia - 641708 AP rilia Atlantic 300 2010 2012 641709 Ducati - 4 34406205 J Ducati - 34906204 Piaggio - 58203R Piaggio - 58208R Piaggio Beverly RST-S 4T 4V IE E3 300 2010 2015 641709
产品单重	克			
检测程序	M325 2632			
电线插头	25CM			
内盒尺寸	12*9.5*6CM			
外箱尺寸	49.5*25.5*30.5CM			
输出电压	14.5±0.5V MOSFET 35安培			
一箱只数	50			
铝壳尺寸				
重要说明				
产品编号	R2025.7A		 <p>1. GND 2. Battery (+) 3. Power Coil 4. Power Coil 5. Power Coil</p>	2631 AP rilia - 641543 AP rilia SRV 4T 8V E3 850 2012 2013 641711 Ducati - 4 34406206 J Piaggio - 58209R Piaggio BV ST 4T 4V IE E4 ABS 350 2017 2018 641711 Piaggio BV 4T 4V IE E3 350 2012 2015 641711 Piaggio Beverly 4T ST IE ABS E4 350
产品单重	450克			
检测程序	M325 2631			
电线插头	黄线1.5 X 60 和红绿线 20CM			
内盒尺寸	12*9.5*6CM			
外箱尺寸	49.5*25.5*30.5CM			
输出电压	14.5±0.5V MOSFET 35安培			
一箱只数	50			
铝壳尺寸				
重要说明				

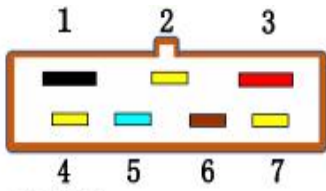

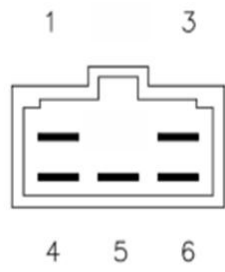

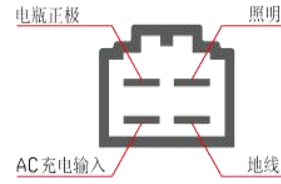
产品资料1		实物主图	接口图	适用范围
产品编号	R2025.8		 1. Battery (+) / Bateria (+) 2. GND / Masa 3. Battery (+) / Bateria (+) 4. GND / Masa 5. Power Coil / Bobina de Carga 6. Power Coil / Bobina de Carga 7. Power Coil / Bobina de Carga	杜卡迪Ducati 848 1098 S 1099cc (2007-2008) SH579B-11
产品单重	450克			
检测程序	M325			
电线插头	黄1.5 X 25CM			
内盒尺寸	12*9.5*6CM			
外箱尺寸	49.5*25.5*30.5CM			
输出电压	14.5±0.5V			
一箱只数	50			
铝壳尺寸				
重要说明				
产品编号	R2025.9B		 1. Battery (+) / Bateria (+) 2. GND / Masa 3. Battery (+) / Bateria (+) 4. GND / Masa 6. Power Coil / Bobina de Carga 7. Power Coil / Bobina de Carga	2482 Honda CB FY SC40 1300 1998 2001 31600-MBG-305 Honda CB X4 DCV SC38 1300 1997 2000 31600-MBG-305 Honda CB X4 DCW SC38 1300 1997 2000 31600-MBG-305 Honda CB X4 DCY SC38 1300 1997 2000 31600-MBG-305 Honda CB X4 DCX SC38 1300 1997 2000 31600-MBG-305
产品单重	450克			
检测程序	M325-2 2482			
电线插头	黄1.5 X 25CM			
内盒尺寸	12*9.5*6CM			
外箱尺寸	49.5*25.5*30.5CM			
输出电压	14.5±0.5V 35安培			
一箱只数	50			
铝壳尺寸				
重要说明				
产品编号	R2025.9C		 1. Battery (+) / Bateria (+) 2. GND / Masa 3. Battery (+) / Bateria (+) 4. GND / Masa 5. Power Coil / Bobina de Carga 6. Power Coil / Bobina de Carga 7. Power Coil / Bobina de Carga	大男孩专用款 Honda VF 750C V45 Magna
产品单重	450克			
检测程序	M325			
电线插头	黄1.5 X 25CM			
内盒尺寸	12*9.5*6CM			
外箱尺寸	49.5*25.5*30.5CM			
输出电压	14.5±0.5V 35安培			
一箱只数	50			
铝壳尺寸				
重要说明				
产品编号	R2025.10		 1. Ignition Switch / Sensor 2. Battery (+) / Bateria (+) 3. GND / Masa 4. Power Coil / Bobina de Carga 5. Power Coil / Bobina de Carga 6. Power Coil / Bobina de Carga	SKU336552 YHC075 春风500 CF500 ATV Areyoursho Voltage Regulator Rectifier Fit CF MOTO 500 CF500 500CC UTV ATV GO KART
产品单重	490克			
检测程序	M325			
电线插头	白1.5 X 25CM			
内盒尺寸	12*9.5*6CM			
外箱尺寸	49.5*25.5*30.5CM			
输出电压	14.5±0.5V			
一箱只数	50			
铝壳尺寸				
重要说明				

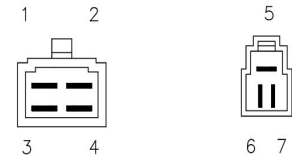
产品资料1		实物主图	接口图	适用范围
产品编号	R2025.10A		 <p>2. Battery (+) / Bateria (+) 3. GND / Masa</p> <p>4. Power Coil / Bobina de Carga 5. Power Coil / Bobina de Carga 6. Power Coil / Bobina de Carga</p>	斯丹尼专用
产品单重	490克			
检测程序	M325			
电线插头	白1.5 X 25CM			
内盒尺寸	12*9.5*6CM			
外箱尺寸	49.5*25.5*30.5CM			
输出电压	14.5±0.5V			
一箱只数	50			
铝壳尺寸				
重要说明				
产品编号	R2025.11		 <p>1. GND / Masa 2. Battery (+) / Bateria (+) 3. GND / Masa 4. Battery (+) / Bateria (+)</p> <p>5. Power Coil / Bobina de Carga 6. Power Coil / Bobina de Carga 7. Power Coil / Bobina de Carga 8. Ignition Switch / Sensor</p>	SH689HA Honda FJS600 All Mo l s 2002-2005 Honda FJS 400 Silverwing 2006-2009 Honda FJS 600 1/2/D3/D4/D5/D6 Silverwing(Non ABS 256mm front disc) 2001-2006 Honda FJS 600 A3-A7/D7 Silverwing(ABS Mo l 276mm front disc) 2003-2009 Honda FSC600 2002-2013
产品单重	510克			
检测程序	M325			
电线插头	黄1.5 X 20 30CM			
内盒尺寸	12*9.5*6CM			
外箱尺寸	49.5*25.5*30.5CM			
输出电压	14.5±0.5V			
一箱只数	50			
铝壳尺寸				
重要说明				
产品编号	R2025.12		 <p>1. Battery (+) / Bateria (+) 2. Battery (+) / Bateria (+) 3. GND / Masa 4. GND / Masa</p> <p>5. Power Coil / Bobina de Carga 6. Power Coil / Bobina de Carga 7. Power Coil / Bobina de Carga</p>	SUZUKI VL800 VL 800 VOLUSIA 2003
产品单重				
检测程序	M325			
电线插头	黑1.5 X 20CM			
内盒尺寸	12*9.5*6CM			
外箱尺寸	49.5*25.5*30.5CM			
输出电压	14.5±0.5V			
一箱只数	50			
铝壳尺寸				
重要说明				
产品编号	R2025.13		 <p>1. Battery (+) / Bateria (+) 2. GND / Masa</p> <p>3. Power Coil / Bobina de Carga 4. Power Coil / Bobina de Carga 5. Power Coil / Bobina de Carga</p>	Suzuki AN Burgman 650 de 2006 a 2011 32800-10G30 Suzuki VZR Intruder 1800 de 2006 a 2012 32800-10G30
产品单重	480克			
检测程序	M325 2597			
电线插头	所有1.5 X 25CM			
内盒尺寸	12*9.5*6CM			
外箱尺寸	49.5*25.5*30.5CM			
输出电压	14.5±0.5V			
一箱只数	50			
铝壳尺寸				
重要说明				

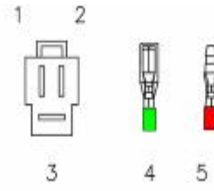

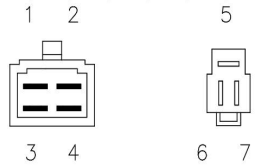
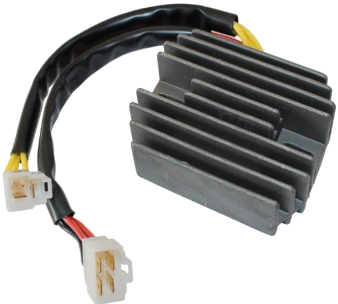
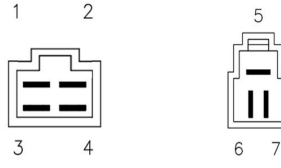

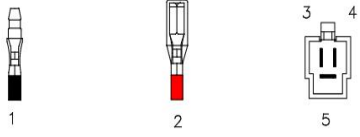

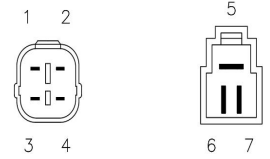
产品资料1		实物主图	接口图	适用范围
产品编号	R2025.14		 <p>1. Battery (+) / Bateria (+) 2. Ignition Switch/ Sensor 3. GND / Masa 4. Battery (+) / Bateria (+) 5. GND / Masa 6. Power Coil / Bobina de Carga 7. Power Coil / Bobina de Carga 8. Power Coil / Bobina de Carga</p>	2472 Kawasaki ZX-12R NINJA 1200 2000 2003 21066-1119 Kawasaki ZX-9R NINJA 900 2000 2003 21066-1119
产品单重				
检测程序	M325 2472			
电线插头	25CM			
内盒尺寸	12*9.5*6CM			
外箱尺寸	49.5*25.5*30.5CM			
输出电压	14.5±0.5V 35安培			
一箱只数	50			
铝壳尺寸				
重要说明				
产品编号	R2025.15		 <p>1. Battery (+) / Bateria (+) 2. Ignition Switch / Sensor 3. GND / Masa 4. Power Coil / Bobina de Carga 5. Power Coil / Bobina de Carga 6. Power Coil / Bobina de Carga</p>	Linhai 300
产品单重	420克			
检测程序	325			
电线插头	20CM			
内盒尺寸	12*9.5*6CM			
外箱尺寸	49.5*25.5*30.5CM			
输出电压	14.5±0.5V			
一箱只数	50			
铝壳尺寸				
重要说明				
产品编号	R2025.16			Polaris (vastaa alku .nro 4010886) - 700 Classic 2006 - 700 Fusion F/O 2006 - 700 HO Touring 2006 - 700 RMK 2006 - 900 Fusion 2005-2006 - 900 Fusion F/O 2006 - 900 RMK (kaikki mallit) 2005-2006 - 900 Switchback 2006
产品单重	克			
检测程序	M325			
电线插头	20CM			
内盒尺寸	12*9.5*6CM			
外箱尺寸	49.5*25.5*30.5CM			
输出电压	14.5±0.5V			
一箱只数	50			
铝壳尺寸				
重要说明				
产品编号	R2025.17		 <p>1. Power Coil / Generator 2. Power Coil / Generator 3. Power Coil / Generator 4. Battery (-) / Bateria (-) 5. Battery (+) / Bateria (+)</p>	cfmoto电喷春风水冷摩托车150NK调压整流器CF150-3
产品单重	克			
检测程序	M325			
电线插头	20CM			
内盒尺寸	12*9.5*6CM			
外箱尺寸	49.5*25.5*30.5CM			
输出电压	14.5±0.5V			
一箱只数	50			
铝壳尺寸				
重要说明				



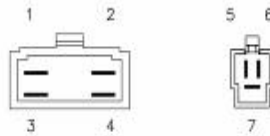

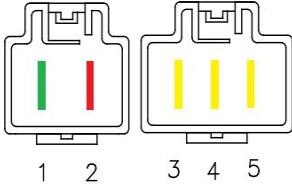
产品资料1		实物主图	接口图	适用范围
产品编号	R2025.18		 <p>1. Power Coil / Bobina de 2. Power Coil / Bobina de 3. Power Coil / Bobina de 4. Ignition Switch/ Sensor 5. Battery (+) / Bateria (+) 6. GND / Masa</p>	59V-81960-A0-00 Yamaha SR 500 from 1978 to 1979 Yamaha YFM Moto-4 225 from 1986—1988 Yamaha YFM Moto-4 250 from 1989—1991 Yamaha YFM Warrior X 350 from 1987—1995 Yamaha YFM FW 350 from 1987—1989 Yamaha YFM Big Bear F 350 from 1990—1994 GY6 250
产品单重	克			
检测程序	M325			
电线插头	25CM			
内盒尺寸	12*9.5*6CM			
外箱尺寸	49.5*25.5*30.5CM			
输出电压	14.5±0.5V			
一箱只数	50			
铝壳尺寸				
重要说明				
产品编号	R2025.18A		 <p>1. Power Coil / Bobina de 2. Power Coil / Bobina de 3. Power Coil / Bobina de 4. Battery (+) / Bateria (+) 5. GND / Masa</p>	三轮摩托车整流器5线 通用
产品单重	净重356克 盒重282克			
检测程序	M325			
电线插头	25CM			
内盒尺寸	12*9.5*6CM			
外箱尺寸	49.5*25.5*30.5CM			
输出电压	14.5±0.5V			
一箱只数	50			
铝壳尺寸				
重要说明				
产品编号	R2025.19		 <p>1. Power Coil / Bobina de Carga 2. Power Coil / Bobina de Carga 3. Power Coil / Bobina de Carga 4. Battery (+) / Bateria (+) 5. GND / Masa</p>	59V-81960-A0-00 Yamaha SR 500 from 1978 to 1979 Yamaha YFM Moto-4 225 from 1986—1988 Yamaha YFM Moto-4 250 from 1989—1991 Yamaha YFM Warrior X 350 from 1987—1995 Yamaha YFM FW 350 from 1987—1989 Yamaha YFM Big Bear F 350 from 1990—1994 林海550 稳压器 GY6 250
产品单重	克			
检测程序	M325			
电线插头	25CM			
内盒尺寸	12*9.5*6CM			
外箱尺寸	49.5*25.5*30.5CM			
输出电压	14.5±0.5V			
一箱只数	50			
铝壳尺寸				
重要说明				
产品编号	R2025.20		 <p>1= GND 2 4 7 = AC 3= Battery (+) 5= Field Coil 6= Ignition Switch</p>	本田CB1000励磁调节器
产品单重	净重356克 盒重282克			
检测程序	M325			
电线插头	25CM			
内盒尺寸	12*9.5*6CM			
外箱尺寸	49.5*25.5*30.5CM			
输出电压	14.5±0.5V			
一箱只数	50			
铝壳尺寸				
重要说明				

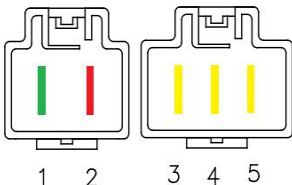

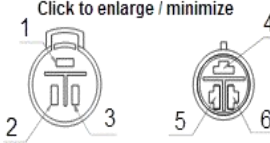

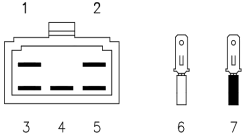

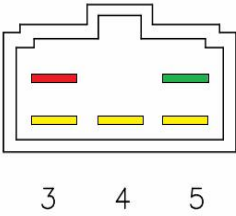
产品资料1		实物主图	接口图	适用范围
产品编号	R2025.21		 <p>1. Battery (+) 3. GND 4. Power Coil 5. Charge Lamp 6. Power Coil</p>	Honda GX610 GX620 GX670 18HP 20HP 24HP 10 AMP
产品单重				
检测程序	M325			
电线插头	25CM			
内盒尺寸	12*9.5*6CM			
外箱尺寸	49.5*25.5*30.5CM			
输出电压	14.5±0.5V			
一箱只数	50			
铝壳尺寸				
重要说明				
产品编号	R2026.0		 <p>电瓶正极 照明 AC充电输入 地线</p>	马来西亚：充电15V 大灯18V0 泰国：充电14V 大灯12.5V0 2026.0// A lication: SH786 DA HONDA DREAM 125 HONDA WAVE 125 R wave 125 ERO100; UNICORN 150 SH742BA CBF150
产品单重	127克			
检测程序	HS08 半波			
电线插头				
内盒尺寸	12*9.5*6CM			
外箱尺寸	49.5*25.5*30.5CM			
输出电压	14.5±0.5V			
一箱只数				
铝壳尺寸				
重要说明				
产品编号	R2027.0		 <p>1. Battery (+) / Bateria (+) 2. GND / Masa 3. Battery (+) / Bateria (+) 4. GND / Masa 5. Power Coil / Bobina de Carga 6. Power Coil / Bobina de Carga 7. Power Coil / Bobina de Carga</p>	Trium h Daytona I 955 1997 2006 T1300560 Trium h Daytona 600 2002 2005 T1300535 Trium h Daytona 650 2002 2005 T1300560 Trium h S eed Four 600 2002 2005 T1300535 Trium h S eed Tri le 1050 1994 2014 T1300560 Trium h S rint ST ABS 1050 2006 31600-MCG-000
产品单重	310克			
检测程序	325			
电线插头	25CM			
内盒尺寸	12*9.5*6CM			
外箱尺寸	49.5*25.5*30.5CM			
输出电压	14.5±0.5V			
一箱只数	50			
铝壳尺寸				
重要说明				
产品编号	R2027.0.1		 <p>1. Power Coil 2. Power Coil 3. Power Coil 4. GND 5. Battery (+)</p>	Honda NX400 FALCON MAGNETRON
产品单重	310克			
检测程序	325			
电线插头	25CM			
内盒尺寸	12*9.5*6CM			
外箱尺寸	49.5*25.5*30.5CM			
输出电压	14.5±0.5V			
一箱只数	50			
铝壳尺寸				
重要说明				

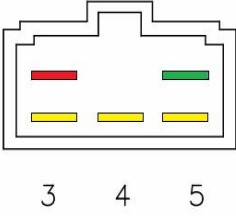
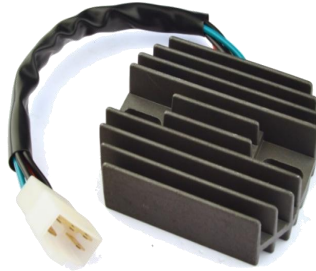
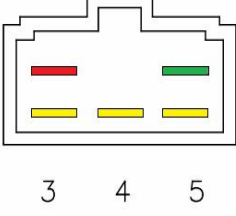

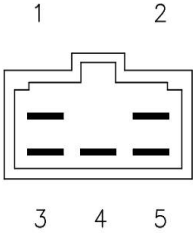

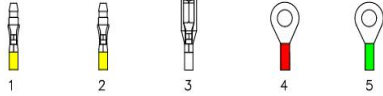
产品资料1		实物主图	接口图	适用范围
产品编号	R2027.0.2		 <p>1. Battery (+) / Bateria (+) 2. GND / Masa 3. Battery (+) / Bateria (+) 4. GND / Masa 5. Power Coil / Bobina de Carga 6. Power Coil / Bobina de Carga 7. Power Coil / Bobina de Carga</p>	Honda Shadow VLX 600 VT600C 1999 2000 2001 2002 2003 2004 2005 2006 2007 Honda Shadow VLX 600 VT600CD luxe 1999 2000 2001 2002 2003 2004 2005 2006 2007
产品单重	310克			
检测程序	325			
电线插头	25CM			
内盒尺寸	12*9.5*6CM			
外箱尺寸	49.5*25.5*30.5CM			
输出电压	14.5±0.5V			
一箱只数	50			
铝壳尺寸				
重要说明				
产品编号	R2027.0.3		 <p>1. Battery (+) / Bateria (+) 2. GND / Masa 3. Battery (+) / Bateria (+) 4. GND / Masa 5. Power Coil / Bobina de Carga 6. Power Coil / Bobina de Carga 7. Power Coil / Bobina de Carga</p>	Trium h Daytona I 955 1997 2006 T1300560 Trium h Daytona 600 2002 2005 T1300535 Trium h Daytona 650 2002 2005 T1300560 Trium h S eed Four 600 2002 2005 T1300535 Trium h S eed Tri le 1050 1994 2014 T1300560 Trium h S rint ST ABS 1050 2006
产品单重	310克			
检测程序	325			
电线插头	25CM			
内盒尺寸	12*9.5*6CM			
外箱尺寸	49.5*25.5*30.5CM			
输出电压	14.5±0.5V			
一箱只数	50			
铝壳尺寸				
重要说明				
产品编号	R2027.0.4		 <p>1. GND / Masa 2. Battery (+) / Bateria (+) 3. Power Coil / Bobina de Carga 4. Power Coil / Bobina de Carga 5. Power Coil / Bobina de Carga</p>	2343 25A Reem lazo ietcard 1376 Yamaha YFB Timberwolf 250 1998 2000 4KB-81960-02 Yamaha YFB250 1997 4KB-81960-01 Yamaha YFB Timberwolf 250 1997 4KB- 81960-01 Yamaha YFM Wolverine 350 1996 1997 4KB-81960-01 Yamaha YFM350 1997 4KB-81960-01 Yamaha YFM Grizzly 600 1998 4KB-
产品单重	310克			
检测程序	315 2343			
电线插头	25CM			
内盒尺寸	12*9.5*6CM			
外箱尺寸	49.5*25.5*30.5CM			
输出电压	14.5±0.5V 25安培			
一箱只数	50			
铝壳尺寸				
重要说明				
产品编号	R2027.1		 <p>1. Battery (+) / Bateria (+) 2. Battery (+) / Bateria (+) 3. GND / Masa 4. GND / Masa 5. Power Coil / Bobina de Carga 6. Power Coil / Bobina de Carga 7. Power Coil / Bobina de Carga</p>	Suzuki DL V-Strom 650 2007 2012 32800-41G00 Suzuki DL 650 2013 2017 32800-47H10 Suzuki GSF Bandit 1250 2007 2009 32800-18H00 Suzuki GSF SA 1250 2016 32800-41G10 Suzuki GSF Bandit 650 2007 2010 32800-18H00 Suzuki GSX R 1000 2005 2008 32800- 21H00 Suzuki GSX R 600 2006 2007 32800-
产品单重	310克			
检测程序	325			
电线插头	20CM			
内盒尺寸	12*9.5*6CM			
外箱尺寸	49.5*25.5*30.5CM			
输出电压	14.5±0.5V			
一箱只数	50			
铝壳尺寸				
重要说明				

产品资料1		实物主图	接口图	适用范围
产品编号	R2027.1.1		 <p>1. Battery (+) / Bateria (+) 2. Battery (+) / Bateria (+) 3. GND / Masa 4. GND / Masa</p> <p>5. Power Coil / Bobina de Carga 6. Power Coil / Bobina de Carga 7. Power Coil / Bobina de Carga</p>	32800-41F11, 32800-06G00, 32800-41G00 Suzuki ATV LT-A700X King Quad 4x4 2005-2006 Suzuki GSF1250S Bandit/ABS 2007-2009 Suzuki GSXR600 2006-2009 2011 Suzuki GSX650F 2008-2009 Suzuki GSXR750 2006-2009 2011 Suzuki GSXR1000 2006-2009 2011 Suzuki GSX1250FA 2011 Suzuki GSXR1300 Hayabusa 2008-2011 Suzuki GSX1300 B-King 2008-2009
产品单重	310克			
检测程序	325			
电线插头	20CM			
内盒尺寸	12*9.5*6CM			
外箱尺寸	49.5*25.5*30.5CM			
输出电压	14.5±0.5V			
一箱只数	50			
铝壳尺寸				
重要说明				
产品编号	R2027.2		 <p>1 GND / Masa 2 Battery (+) / Bateria (+) 3 GND / Masa 4 Battery (+) / Bateria (+)</p> <p>5 Power Coil 6 Power Coil 7 Power Coil</p>	1990 Honda Transal 600 XL600V 1989 Honda Transal 600 XL600V Honda XV 600 Transal 1987 1988 1989 1990 1991 1992 HONDA CBX1000 rolink Voltage Regulator Rectifier 1979-1982
产品单重	310克			
检测程序	325			
电线插头	20CM			
内盒尺寸	12*9.5*6CM			
外箱尺寸	49.5*25.5*30.5CM			
输出电压	14.5±0.5V			
一箱只数	50			
铝壳尺寸				
重要说明				
产品编号	R2027.2.1		 <p>1. Battery (+) / Bateria (+) 2. GND / Masa 3. Battery (+) / Bateria (+) 4. GND / Masa</p> <p>5. Power Coil / Bobina de Carga 6. Power Coil / Bobina de Carga 7. Power Coil / Bobina de Carga</p>	HONDA XL V 600 Transal 1991 / 1999
产品单重	310克			
检测程序	325			
电线插头	35CM			
内盒尺寸	12*9.5*6CM			
外箱尺寸	49.5*25.5*30.5CM			
输出电压	14.5±0.5V			
一箱只数	50			
铝壳尺寸				
重要说明				
产品编号	R2027.2.2		 <p>1. Battery (+) / Bateria (+) 2. GND / Masa 3. Battery (+) / Bateria (+) 4. GND / Masa</p> <p>5. Power Coil / Bobina de Carga 6. Power Coil / Bobina de Carga 7. Power Coil / Bobina de Carga</p>	2012 Yamaha YZF R1 -- 2011 Yamaha YZF R1 -- 2010 Yamaha YZF R1 -- 2010 Yamaha YZF R1 Limited Edition 2009 Yamaha YZF R1 -- 2003 Yamaha YZF R1 -- 2002 Yamaha YZF R1
产品单重	310克			
检测程序	325			
电线插头	25CM			
内盒尺寸	12*9.5*6CM			
外箱尺寸	49.5*25.5*30.5CM			
输出电压	14.5±0.5V			
一箱只数	50			
铝壳尺寸				
重要说明				





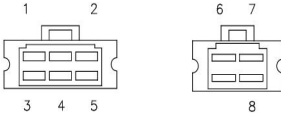

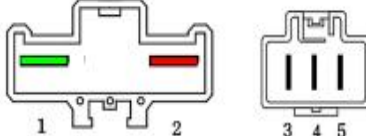
产品资料1		实物主图	接口图	适用范围
产品编号	R2027.2.3		 <p>1. Battery (+) / Bateria (+) 2. GND / Masa 3. Battery (+) / Bateria (+) 4. GND / Masa 5. Power Coil / Bobina de Carga 6. Power Coil / Bobina de Carga 7. Power Coil / Bobina de Carga</p>	Yamaha Royal Star Tour luxe TDM Virago 250 850 1300 1993-2001 Yamaha Royal Star 1300 XVZ1300A 1996-2000 Yamaha Royal Star 1300 Boulevard XVZ1300AL 2001 Yamaha Royal Star 1300 Tour Classic XVZ1300AT 1996-2000 Yamaha Royal Star 1300 Tour luxe XVZ1300CT 1997-2001 Yamaha TDM 850 1993
产品单重	310克			
检测程序	325			
电线插头	35CM			
内盒尺寸	12*9.5*6CM			
外箱尺寸	49.5*25.5*30.5CM			
输出电压	14.5±0.5V			
一箱只数	50			
铝壳尺寸				
重要说明				
产品编号	R2027.3		 <p>1. GND 2. Battery (+) 3. Power Coil 4. Power Coil 5. Power Coil</p>	HONDA CBR1000RR CBR1000 RR 2004-2007
产品单重	310克			
检测程序	M325			
电线插头	所有1.5 X 20CM			
内盒尺寸	12*9.5*6CM			
外箱尺寸	49.5*25.5*30.5CM			
输出电压	14.5±0.5V			
一箱只数	50			
铝壳尺寸				
重要说明				
产品编号	R2027.3.1		 <p>1. GND 2. Battery (+) 3. Power Coil 4. Power Coil 5. Power Coil</p>	Honda CBR 1000 RR 2004-2007 Honda CBR 600 RR 2003-2006 31600-MEE-003 31600-MEL-013 31600-MEL-A21 31600-MEE-872
产品单重	310克			
检测程序	M325			
电线插头	所有1.5 X 25CM			
内盒尺寸	12*9.5*6CM			
外箱尺寸	49.5*25.5*30.5CM			
输出电压	14.5±0.5V			
一箱只数	50			
铝壳尺寸				
重要说明				
产品编号	R2027.4		 <p>Click to enlarge / minimize</p> <p>1.Yellow / Amarillo : Power Coil / Generador 2.Yellow / Amarillo : Power Coil / Generador 3.Yellow / Amarillo : Power Coil / Generador 4.Green / Verde : Battery (-) / Bateria (-) 5.Black / Negro : Sensor / Sensor 6.Red / Rojo : Battery (+) / Bateria (+)</p>	2456 HondaATCES / SX250 1985 198731600-HA0-000 HondaTRX250 1985 198731600-HA8-770
产品单重	310克			
检测程序	325 2456			
电线插头	55CM			
内盒尺寸	12*9.5*6CM			
外箱尺寸	49.5*25.5*30.5CM			
输出电压	14.5±0.5V 25安培			
一箱只数	50			
铝壳尺寸				
重要说明				



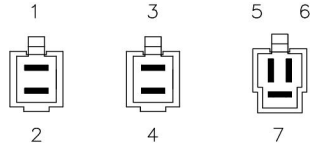

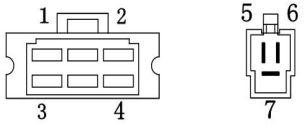
产品资料1		实物主图	接口图	适用范围
产品编号	R2027.5		 <p>1. Battery (+) / Bateria (+) 2. GND / Masa 3. Power Coil / Bobina de Carga 4. Power Coil / Bobina de Carga 5. Power Coil / Bobina de Carga 6. Field Coil / Bobina de Campo 7. Ignition Switch / Sensor</p>	2330 25A CAM 0 + Honda CB F 400 1976 1978 31400-333-004 Honda CB F 350 1972 1975 Honda CB K 500 1971 1973 Honda CB F Super Sport 550 1975 1977 31400-300-035 Honda CB Hondamatic 750 1976 1978 31400-300-035 Honda CB F Super Sport SOHC 750 1975 1978 31400-300-035
产品单重	310克			
检测程序	CB750+励磁 2330			
电线插头	25CM			
内盒尺寸	12*9.5*6CM			
外箱尺寸	49.5*25.5*30.5CM			
输出电压	14.5±0.5V 25安培			
一箱只数	50			
铝壳尺寸				
重要说明				
产品编号	R2027.6		 <p>1. Battery (+) 2. GND 3. Power Coil 4. Power Coil 5. Power Coil</p>	2010 Triumph Sprint ST ATV 2009 Triumph Sprint ST 2008 Triumph Sprint ST 2007 Triumph Sprint ST 2006 Triumph Sprint ST 2005 Triumph Sprint ST 2004 Triumph Sprint ST 2003 Triumph Sprint RS 2003 Triumph Sprint ST 2002 Triumph Sprint RS 2002 Triumph Sprint ST
产品单重	310克			
检测程序	325			
电线插头	20CM			
内盒尺寸	12*9.5*6CM			
外箱尺寸	49.5*25.5*30.5CM			
输出电压	14.5±0.5V			
一箱只数	50			
铝壳尺寸				
重要说明	3黑线1红1绿 白色铝壳			
产品编号	R2027.6.1		 <p>1. Battery (+) 2. GND 3. Power Coil 4. Power Coil 5. Power Coil</p>	2312 Reem lazo Kokusan nki RS41-29 Suzuki - 32800-33E21 Suzuki GSX R 600 2001 2005 32800-33E20 Suzuki GSX R 750 1998 2005 32800-33E20 Suzuki GSX R 1000 2001 2004 32800-33E20 Suzuki GSX R 600 1997 2000 32800-33E00
产品单重	330克			
检测程序	325 2312			
电线插头	25CM			
内盒尺寸	12*9.5*6CM			
外箱尺寸	49.5*25.5*30.5CM			
输出电压	14.5±0.5V 35安培			
一箱只数	50			
铝壳尺寸				
重要说明	3黄1红1绿			
产品编号	R2027.6.2		 <p>1. Battery (+) 2. GND 3. Power Coil 4. Power Coil 5. Power Coil</p>	Reem lazo Kokusan nki RS41-29 Suzuki - 32800-33E21 Suzuki - 32800-44D10 Suzuki GSX R 750 1998 2005 32800-33E20 Suzuki GSX R 1000 2001 2004 32800-33E20 Suzuki GSX R - Hayabusa 1300 1999 2006 32800-33E20 Suzuki GSX R / RZ - Hayabusa 1300 1999 2003 32800-33E10
产品单重	330克			
检测程序	325 2312			
电线插头	25CM			
内盒尺寸	12*9.5*6CM			
外箱尺寸	49.5*25.5*30.5CM			
输出电压	14.5±0.5V 35安培			
一箱只数	50			
铝壳尺寸				
重要说明	3黑线1红1绿			

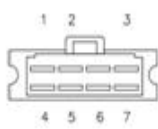

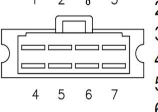

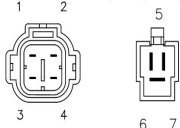

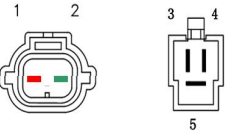
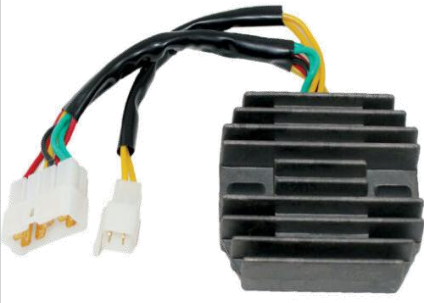
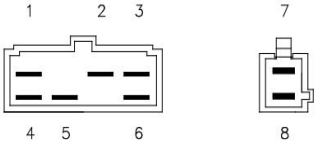
产品资料1		实物主图	接口图	适用范围
产品编号	R2027.6.3		 <p>1. Battery (+) 2. GND 3. Power Coil 4. Power Coil 5. Power Coil</p>	Kawasaki EJ W 650 1999 2005 21066-1106 Kawasaki VN Vulcan Classic 1500 1996 2008 21066-1106 Kawasaki VN Vulcan Nomad 1500 1999 2001 21066-1106 Kawasaki VN Vulcan Nomad FI 1500 2000 2004 21066-1106 Kawasaki VN Vulcan Nomad 1600 2005 2008 21066-1106 Kawasaki VN Vulcan Classic 1600
产品单重	350克			
检测程序	325			
电线插头	35CM			
内盒尺寸	12*9.5*6CM			
外箱尺寸	49.5*25.5*30.5CM			
输出电压	14.5±0.5V			
一箱只数	50			
铝壳尺寸				
重要说明	3白线1红1黑			
产品编号	R2027.7		 <p>1. Power Coil / Bobina de Carga (Yellow/ Amarillo) 2. Power Coil / Bobina de Carga (Yellow/ Amarillo) 3. Charge Lamp/ Lámpara Piloto 4. Battery (+) / Bateria (+) (Red/ Rojo) 5. GND/ Masa (Green/ Verde)</p>	Ducati antah 500 SL 1979 1980 1981 Euro Mo Is Cagiva 650 Elefant Cagiva 650 Elefant Laverda 600 Atlas Laverda 650 Ghost Laverda 650 IE Laverda 668 IE Ducati M400 Monster Ducati 450 smo Ducati 450 MK3 Ducati 500 GTL
产品单重	310克			
检测程序	QF2101 新款			
电线插头	25CM			
内盒尺寸	12*9.5*6CM			
外箱尺寸	49.5*25.5*30.5CM			
输出电压	14.5±0.5V			
一箱只数	50			
铝壳尺寸				
重要说明				
产品编号	R2027.7.1			Handle U To 350 Watts (Fits: More than one vehicle) 1960 AJS Mo l 14 CS 1963 AJS Mo l 14S Sa hire S orts Single 1965 AJS Mo l 16 S ectre 1955 AJS Mo l 16 MS 1963 AJS Mo l 18 S 1956 AJS Mo l 20 Twin 1971 AJS Stormer Y41 2007 All American Cho ers Greem
产品单重	310克			
检测程序	325			
电线插头	55CM			
内盒尺寸	12*9.5*6CM			
外箱尺寸	49.5*25.5*30.5CM			
输出电压	14.5±0.5V			
一箱只数	50			
铝壳尺寸				
重要说明				
产品编号	R2027.7.2			21066-025 21066-1119 26H-81960-A0-00 2WR-81960-A0-00 3005-057 31600-MAT-D50 31600-MAT-D51 31600-MAT-E01 31600-MB4-008 31600-MBG-306 31600-MCF-003 31600-MCF-d30 31600-MG8-008 31600-MK3-000 31600-MN0-008 32800-05A00 32800-12E01 32800-33E00 62511034100 Kawasaki KLF 400 Bayou 4x4 1993-1999 Suzuki LTF 500 F Quadrunner 4x4 Manual 1998-1999
产品单重	310克			
检测程序	325			
电线插头	55CM			
内盒尺寸	12*9.5*6CM			
外箱尺寸	49.5*25.5*30.5CM			
输出电压	14.5±0.5V			
一箱只数	50			
铝壳尺寸				
重要说明				

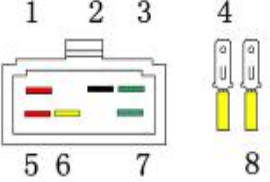

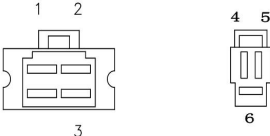

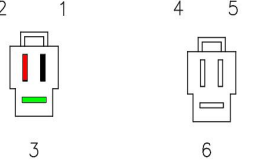
产品资料1		实物主图	接口图	适用范围
产品编号	R2027.7.4		 <ol style="list-style-type: none"> 1. Battery (+) / Bateria (+) (Red/Rojo) 2. GND / Masa (Black/Negro) 3. Power Coil / Bobina de Carga (Yellow/Amarillo) 4. Power Coil / Bobina de Carga (Yellow/Amarillo) 5. Power Coil / Bobina de Carga (Yellow/Amarillo) 	Suzuki GSXR1000
产品单重	310克			
检测程序	325			
电线插头	25CM			
内盒尺寸	12*9.5*6CM			
外箱尺寸	49.5*25.5*30.5CM			
输出电压	14.5±0.5V			
一箱只数	50			
铝壳尺寸				
重要说明				
产品编号	R2027.8		 <ol style="list-style-type: none"> 1. Field Coil / Bobina de Campo 2. Ignition Switch / Sensor 3. Power Coil / Bobina de Carga 4. Power Coil / Bobina de Carga 5. Power Coil / Bobina de Carga 6. Power Coil / Bobina de Carga 7. Battery (+) / Bateria (+) 8. Ignition Switch / Sensor 	2514 HondaCBSC NightHawk700 1984 1986 31600-MJ1-780 HondaCBX E750198431600-MJ1-671 HondaCBX 2750 1994 199831600-MJ1-672 HondaCBX 2H750198731600-MJ1-672 HondaCBX 21750200131600-MJ1-672 Reem lazoShin ngenSH255-12
产品单重	340克			
检测程序	CB750+励磁 2514 2538			
电线插头	25CM			
内盒尺寸	0			
外箱尺寸	49.5*25.5*30.5CM			
输出电压	14.5±0.5V 25安培			
一箱只数	50			
铝壳尺寸				
重要说明				
产品编号	R2027.8.1		 <ol style="list-style-type: none"> 1. Field Coil / Bobina de Campo 2. Ignition Switch / Sensor 3. Power Coil / Bobina de Carga 4. Power Coil / Bobina de Carga 5. Power Coil / Bobina de Carga 6. Power Coil / Bobina de Carga 7. Battery (+) / Bateria (+) 8. Ignition Switch / Sensor 	2335 25A CAM 0 - Honda CB 650 1981 1982 31600-460-731 Honda CB 650 1979 1980 31600-426-000 Honda CBX F/F2 750 1984 1986 31600-MJ0-612 Honda CBX /F 400 1985 31600-MJ0-612
产品单重	310克			
检测程序	CB750+励磁 2335			
电线插头	25CM			
内盒尺寸	12*9.5*6CM			
外箱尺寸	49.5*25.5*30.5CM			
输出电压	14.5±0.5V 25安培			
一箱只数	50			
铝壳尺寸				
重要说明				
产品编号	R2027.9		 <ol style="list-style-type: none"> 1. GND (-) 2. Battery (+) 3. Power coil 4. Power coil 5. Power coil 	Honda RVT1000R VFR800
产品单重	310克			
检测程序	M325			
电线插头	35CM			
内盒尺寸	12*9.5*6CM			
外箱尺寸	49.5*25.5*30.5CM			
输出电压	14.5±0.5V			
一箱只数	50			
铝壳尺寸				
重要说明				

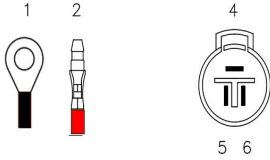

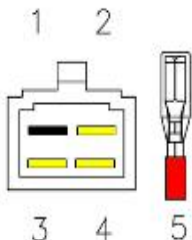

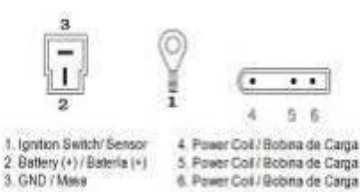
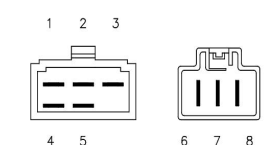

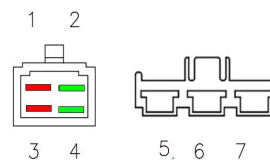
产品资料1		实物主图	接口图	适用范围
产品编号	R2027.9.1		 <p>1. Battery (+) / Bateria (+) 5. GND / Masa 2. GND / Masa 6. Power Coil / Bobina de Carga 3. Ignition Switch / Sensor 7. Power Coil / Bobina de Carga 4. Battery (+) / Bateria (+) 8. Power Coil / Bobina de Carga</p>	Honda VFR FI 800 from 2000 to 2001 31600-MBG-D01 Honda VFR FI 800 from 2000 to 2001 31600-MBG-306 Honda VFR800A (2002-2009) Honda RVT1000R RC51 (2000-2006) Honda VFR 800 from 2002 to 2003 31600-MCW-D01 Honda VFR ABS 800 from 2004 to 2009 31600-MCW-D61 Honda VFR 800 from 2004 to 2009
产品单重	310克			
检测程序	M325			
电线插头	35CM			
内盒尺寸	12*9.5*6CM			
外箱尺寸	49.5*25.5*30.5CM			
输出电压	14.5±0.5V			
一箱只数	50			
铝壳尺寸				
重要说明				
产品编号	R2027.9.2		 <p>1. Battery (+) / Bateria (+) 5. GND / Masa 2. GND / Masa 6. Power Coil / Bobina de Carga 3. Ignition Switch / Sensor 7. Power Coil / Bobina de Carga 4. Battery (+) / Bateria (+) 8. Power Coil / Bobina de Carga</p>	31600-MCH-000 31600-MCJ-750 Honda CBR 954 RR VTX C R S 1800 2002-2008 Honda CBR 954 RR 2002-2003 Honda VTX 1800 C 2002-2008 Honda VTX 1800 C S ec 1 2005-2008 Honda VTX 1800 C S ec 2 2005-2008 Honda VTX 1800 C S ec 3 2005-2007 Honda VTX 1800 C TEC 2002-2008 Honda VTX 1800 R Retro 2002-2007 Honda VTX 1800 S S oke Wheel 2002-2006
产品单重	310克			
检测程序	M325			
电线插头	25CM			
内盒尺寸	12*9.5*6CM			
外箱尺寸	49.5*25.5*30.5CM			
输出电压	14.5±0.5V			
一箱只数	50			
铝壳尺寸				
重要说明				
产品编号	R2027.10		 <p>1. Battery (+) / Bateria (+) 2. GND / Masa 3. Power Coil / Bobina de Carga 4. Power Coil / Bobina de Carga 5. Power Coil / Bobina de Carga</p>	YAMAHA XV1600 ROAD STAR 1600 SILVERADO 1999-2003 SUZUKI DL1000 V-STROM 1000 2001 2002 Harley Davidson Heritage Softail 1450 Classic - FLSTC1450 2001-2006 Yamaha WaveRunner 1100 FX Cruiser Sport 05-09 WSM RECTIFIER YAMAHA VX110 Honda TRX450FE EMAN ES 2002 2003 2004 YAMAHA V-STAR 1100 CLASSIC XVS11
产品单重	270克			
检测程序	325			
电线插头				
内盒尺寸	12*9.5*6CM			
外箱尺寸	49.5*25.5*30.5CM			
输出电压	14.5±0.5V			
一箱只数	50			
铝壳尺寸				
重要说明				
产品编号	R2027.10.1		 <p>1. Battery (+) / Bateria (+) 2. Ignition Switch / Sensor 3. GND / Masa 4. Power Coil / Bobina de Carga 5. Power Coil / Bobina de Carga 6. Power Coil / Bobina de Carga</p>	2443 KawasakiKEFLakota300 1995 200021066-1089 KawasakiKEFLakota Sport300 2001 200321066-1089 KawasakiKFX300 2001 200421066-1089 KawasakiKLFBayou300 1988 199121066-1101 KawasakiKLFBayou 4x4300 1989 2002 21066-1089 KawasakiKLFBayou300 1988 199121066-
产品单重	270克			
检测程序	325 2443			
电线插头				
内盒尺寸	12*9.5*6CM			
外箱尺寸	49.5*25.5*30.5CM			
输出电压	14.5±0.5V 25安培			
一箱只数	50			
铝壳尺寸				
重要说明				

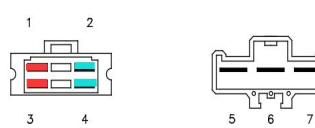

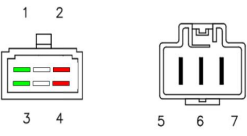

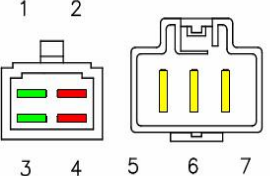

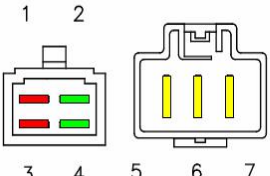
产品资料1		实物主图	接口图	适用范围
产品编号	R2027.11		 <p>1. Battery (+) / Bateria (+) (Red/Rojo) 2. Battery (+) / Bateria (+) (Red/Rojo) 3. GND / Masa (Green/Verde) 4. GND / Masa (Green/Verde) 5. Power Coil / Bobina de Carga 6. Power Coil / Bobina de Carga 7. Power Coil / Bobina de Carga</p>	Honda VT C Shadow 1100 2001 2003 31600-MCK-A01 Honda VT C Shadow 1100 1995 1997 31600-MAH-008 Honda VT C Shadow 1100 1997 1998 31600-MAA-A01 Honda VT C2 Shadow 1100 1997 1999 31600-MAA-A01 Honda VT C Shadow 1100 1987 1994 31600-MM8-008 Honda VT C3 Shadow 1100 2001 2002
产品单重	330克			
检测程序	325			
电线插头	45CM			
内盒尺寸	12*9.5*6CM			
外箱尺寸	49.5*25.5*30.5CM			
输出电压	14.5±0.5V			
一箱只数	50			
铝壳尺寸				
重要说明				
产品编号	R2027.12		 <p>1 GND / Masa 5 Power Coil 2 Battery (+) / Bateria (+) 6 Power Coil 3 GND / Masa 7 Power Coil 4 Battery (+) / Bateria (+)</p>	Honda VF 700 Magna -- 1985-1986 Honda VT 700 Shadow -- 1986-1987 Honda VT 800 Shadow -- 1988 31600-MR6-000 31600-MK3-000 31600-MK7-008
产品单重	310克			
检测程序	325			
电线插头	35CM			
内盒尺寸	12*9.5*6CM			
外箱尺寸	49.5*25.5*30.5CM			
输出电压	14.5±0.5V			
一箱只数	50			
铝壳尺寸				
重要说明				
产品编号	R2027.13		 <p>1. Battery (+) / Bateria (+) 2. Power Coil / Bobina de Carga 3. GND / Masa 4. Battery (+) / Bateria (+) 5. Power Coil / Bobina de Carga 6. Power Coil / Bobina de Carga 7. GND / Masa</p>	2307 25A Honda CB HondaMatic 750 1977 1978 31700-371-000 Honda GL Goldwing 1100 1980 1983 31600-MG9-010 Honda GL Goldwing 1100 1980 1983 31600-463-008 Honda GL Goldwing DG 1200 1984 1987 31600-MG9-000 Honda GL Goldwing DG 1200 1984 1987 31600-MG9-010
产品单重	310克			
检测程序	325 2307			
电线插头	35CM			
内盒尺寸	12*9.5*6CM			
外箱尺寸	49.5*25.5*30.5CM			
输出电压	14.5±0.5V 25安培			
一箱只数	50			
铝壳尺寸				
重要说明				
产品编号	R2027.13.1		 <p>1. Battery (+) / Bateria (+) 2. Power Coil / Bobina de Carga 3. GND / Masa 4. Battery (+) / Bateria (+) 5. Power Coil / Bobina de Carga 6. Power Coil / Bobina de Carga 7. GND / Masa 8. Ignition Switch/ Sensor</p>	Honda CB HondaMatic 750 1977 1978 31700-371-000 Honda GL Goldwing 1100 1980 1983 31600-MG9-010 Honda GL Goldwing 1100 1980 1983 31600-463-008 Honda GL Goldwing DG 1200 1984 1987 31600-MG9-000 Honda GL Goldwing DG 1200 1984 1987 31600-MG9-010 Honda GL Goldwing 1000 1977 1979
产品单重	310克			
检测程序	325			
电线插头	30 CM			
内盒尺寸	12*9.5*6CM			
外箱尺寸	49.5*25.5*30.5CM			
输出电压	14.5±0.5V			
一箱只数	50			
铝壳尺寸				
重要说明				

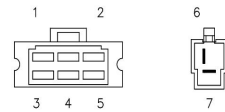

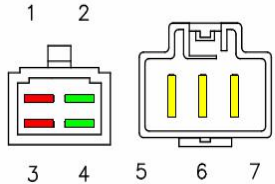

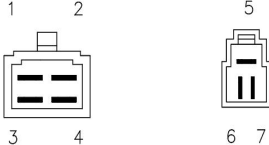

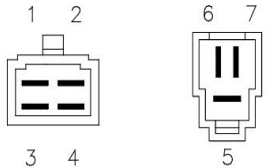
产品资料1		实物主图	接口图	适用范围
产品编号	R2027.14		 <p>1. Battery (+) / Bateria (+) 2. Battery (+) / Bateria (+) 3. GND / Masa 4. GND / Masa</p> <p>5. Power Coil / Bobina de Carga 6. Power Coil / Bobina de Carga 7. Power Coil / Bobina de Carga</p>	2455 Arctic Cat-3530-028 Arctic CatATVAUTO 4x440020033402-682 Arctic CatATVAUTO 4x4400 2004 2005 3402-682 Arctic CatATVTBX AUTO 4x440020063402-682 Arctic CatATVV AUTO 4x4400 2005 20063402-682 Arctic CatATVFIS AUTO 2x4 / 4x4400 2003 20083402-682
产品单重	310克			
检测程序	325 2455			
电线插头	25CM			
内盒尺寸	12*9.5*6CM			
外箱尺寸	49.5*25.5*30.5CM			
输出电压	14.5±0.5V 35安培			
一箱只数	50			
铝壳尺寸				
重要说明				
产品编号	R2027.14.1		 <p>1. Battery (+) / Bateria (+) 2. GND / Masa</p> <p>3. Power Coil / Bobina de Carga 4. Power Coil / Bobina de Carga 5. Power Coil / Bobina de Carga</p>	Arctic Cat ATV TRV 500 2008 3530-059 Arctic Cat ATV MAN / AUTO 400 2008 3530-059 Arctic Cat ATV 4x4 AUTO 500 2000 2002 3530-059 Arctic Cat ATV FIS 4x4 MAN / AUTO 500 2002 2004 3530-059 Arctic Cat ATV TBX 4x4 AUTO 500 2003 2006 3530-059 Arctic Cat ATV TRV 4x4 AUTO 500 2003 2006 3530-059
产品单重	310克			
检测程序	325			
电线插头	25CM			
内盒尺寸	12*9.5*6CM			
外箱尺寸	49.5*25.5*30.5CM			
输出电压	14.5±0.5V			
一箱只数	50			
铝壳尺寸				
重要说明				
产品编号	R2027.15		 <p>1. Battery (+) / Bateria (+) 2. Ignition Switch / Sensor 3. GND / Masa 4. Battery (+) / Bateria (+)</p> <p>5. Power Coil / Bobina de Carga 6. GND / Masa 7. Power Coil / Bobina de Carga 8. Power Coil / Bobina de Carga</p>	2337 35A Honda GL L Goldwing 1200 1985 31600-MG9-951 Honda GL SEI Goldwing 1200 1986 31600-ML8-305
产品单重	310克			
检测程序	325 2337			
电线插头	25CM			
内盒尺寸	12*9.5*6CM			
外箱尺寸	49.5*25.5*30.5CM			
输出电压	14.5±0.5V 35			
一箱只数	50			
铝壳尺寸				
重要说明				
产品编号	R2027.15.1		 <p>1 Battery(+) 2 Ignition switch 3 GND(-) 5 Battery(+)</p> <p>7 GND(-) 4 POWER COIL 6 POWER COIL 8 POWER COIL</p>	Honda GL1200 SEI/LTD Goldwing (85-87)
产品单重	310克			
检测程序	325			
电线插头	25CM			
内盒尺寸	12*9.5*6CM			
外箱尺寸	49.5*25.5*30.5CM			
输出电压	14.5±0.5V			
一箱只数	50			
铝壳尺寸				
重要说明				

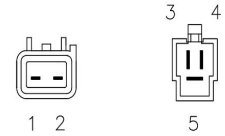

产品资料1		实物主图	接口图	适用范围
产品编号	R2027.16		 <p>1. Ignition Switch / Sensor 2. Battery (+) / Bateria (+) 3. GND / Masa</p> <p>4. Power Coil / Bobina de Carga 5. Power Coil / Bobina de Carga 6. Power Coil / Bobina de Carga</p>	HONDA CM200T TWINSTAR CM 200 T 1981 1982
产品单重	310克			
检测程序	325			
电线插头	35CM			
内盒尺寸	12*9.5*6CM			
外箱尺寸	49.5*25.5*30.5CM			
输出电压	14.5±0.5V			
一箱只数	50			
铝壳尺寸				
重要说明				
产品编号	R2027.17		 <p>1. Ignition Switch/ Sensor 2. Battery (+) / Bateria (+) 3. GND / Masa</p> <p>4. Power Coil / Bobina de Carga 5. Power Coil / Bobina de Carga 6. Power Coil / Bobina de Carga</p>	HONDA CM200T TWINSTAR CM 200 T 1981 1982
产品单重	310克			
检测程序	325			
电线插头	35CM			
内盒尺寸	12*9.5*6CM			
外箱尺寸	49.5*25.5*30.5CM			
输出电压	14.5±0.5V			
一箱只数	50			
铝壳尺寸				
重要说明				
产品编号	R2027.18		 <p>1. GND / Masa 2. Battery (+) / Bateria (+)</p> <p>4. Power Coil / Bobina de Carga 5. Power Coil / Bobina de Carga 6. Power Coil / Bobina de Carga</p>	YAMAHA MARINE 80 H 80H OUTBOARD ENGINE 1999-2003 MERCURY MARINE 75 H 75H 4-Stroke Engine 2000-2005 YAMAHA MARINE 100 H 100H ENGINE 1999-2003 MERCURY MARINE 90 90H 90-H 4-Stroke 2000-2005
产品单重	310克			
检测程序	325			
电线插头	25CM			
内盒尺寸	12*9.5*6CM			
外箱尺寸	49.5*25.5*30.5CM			
输出电压	14.5±0.5V			
一箱只数	50			
铝壳尺寸				
重要说明				
产品编号	R2027.18.1		 <p>1. Power Coil 2. GND 3. Power Coil 4. Power Coil 5. Battery (+)</p>	YAMAHA YFM350 Big Bear 4x4 1990-1997 1995 Yamaha YFM350ER Moto-4 1997 Yamaha YFM350FW Big Bear 4x4 1996 Yamaha YFM350FW Big Bear 4x4 1995 Yamaha YFM350FW Big Bear 4x4 1994 Yamaha YFM350FW Big Bear 4x4 1993 Yamaha YFM350FW Big Bear 4x4 1992 Yamaha YFM350FW Big Bear 4x4 1991 Yamaha YFM350FW Big Bear 4x4 1990 Yamaha YFM350FW Big Bear 4x4
产品单重	300克			
检测程序	325			
电线插头	25CM			
内盒尺寸	12*9.5*6CM			
外箱尺寸	49.5*25.5*30.5CM			
输出电压	14.5±0.5V			
一箱只数	50			
铝壳尺寸				
重要说明				

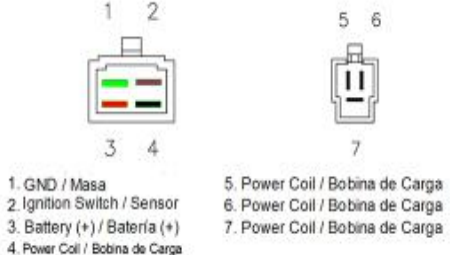



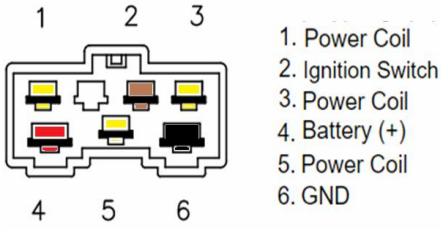

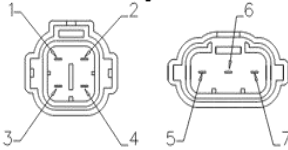
产品资料1		实物主图	接口图	适用范围
产品编号	R2027.19		 <p>1. Ignition Switch / Sensor 2. Battery (+) / Bateria (+) 3. GND / Masa 4. Power Coil / Bobina de Carga 5. Power Coil / Bobina de Carga 6. Power Coil / Bobina de Carga</p>	BMW F650ST 1997 1998 BMW F650 1997 -2001
产品单重	300克			
检测程序	325			
电线插头	25CM			
内盒尺寸	12*9.5*6CM			
外箱尺寸	49.5*25.5*30.5CM			
输出电压	14.5±0.5V			
一箱只数	50			
铝壳尺寸				
重要说明				
产品编号	R2027.20		 <p>1. Battery (+) / Bateria (+) 2. GND / Masa 3. Ignition Switch / Sensor 4. Battery (+) / Bateria (+) 5. GND / Masa 6. Power Coil / Bobina de Carga 7. Power Coil / Bobina de Carga 8. Power Coil / Bobina de Carga</p>	Honda CBR 954 Firebla 900 2002 2003 31600-MCJ-750 Reem lazo Shin ngen SH678-DA
产品单重	310克			
检测程序	M325			
电线插头	黄1.5 X 35CM			
内盒尺寸	12*9.5*6CM			
外箱尺寸	49.5*25.5*30.5CM			
输出电压	14.5±0.5V			
一箱只数	50			
铝壳尺寸				
重要说明				
产品编号	R2027.21		 <p>1. Battery (+) / Bateria (+) 2. GND / Masa 3. Battery (+) / Bateria (+) 4. GND / Masa 5. Power Coil / Bobina de Carga 6. Power Coil / Bobina de Carga 7. Power Coil / Bobina de Carga</p>	Aprilia
产品单重	310克			
检测程序	M325 2593			
电线插头	黄1.5 X 25 75CM			
内盒尺寸	12*9.5*6CM			
外箱尺寸	49.5*25.5*30.5CM			
输出电压	14.5±0.5V 35安培 MOSFET			
一箱只数	50			
铝壳尺寸				
重要说明				
产品编号	R2027.21.1		 <p>1. Battery (+) / Bateria (+) 2. GND / Masa 3. Battery (+) / Bateria (+) 4. GND / Masa 5. Power Coil / Bobina de Carga 6. Power Coil / Bobina de Carga 7. Power Coil / Bobina de Carga</p>	2581 APriIiaETVCa o Nord ABS1000 2004 2007A 8124831 APriIiaETVCa o Nord Rally1000 2001 2003A 8124831 APriIiaRSTFutura1000 2001 2004A 8124831
产品单重	310克			
检测程序	M325 2581			
电线插头	黄1.5 X 25CM			
内盒尺寸	12*9.5*6CM			
外箱尺寸	49.5*25.5*30.5CM			
输出电压	14.5±0.5V MOSFET 35安培			
一箱只数	50			
铝壳尺寸				
重要说明				



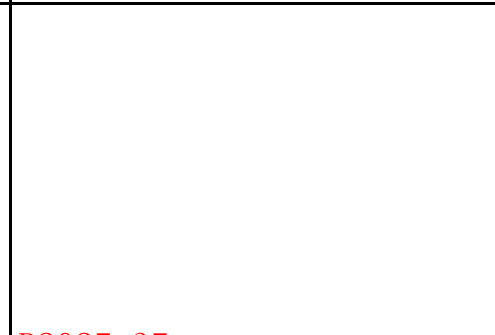

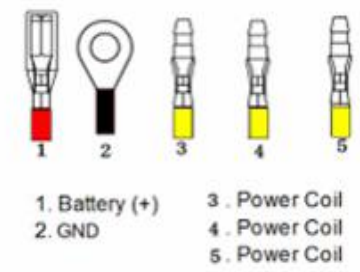

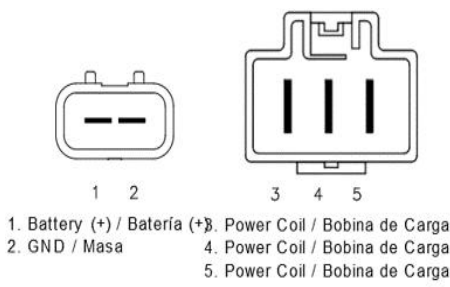
产品资料1		实物主图	接口图	适用范围
产品编号	R2027.22		 <p>1. GND/ Masa 2. Battery (+) / Batería (+) 3. GND/ Masa 4. Battery (+) / Batería (+) 5. Power Coil / Bobina de Carga 6. Power Coil / Bobina de Carga 7. Power Coil / Bobina de Carga</p>	Honda CBR F4i 600 2001 2004 31600-MBW-D21 Honda CBR F4i 600 2005 2006 31600-MBW-G90 Reem lazo Shin ngen SH678 A
产品单重	340克			
检测程序	M325			
电线插头	45CM			
内盒尺寸	12*9.5*6CM			
外箱尺寸	49.5*25.5*30.5CM			
输出电压	14.5±0.5V			
一箱只数	50			
铝壳尺寸				
重要说明				
产品编号	R2027.22.1		 <p>1. GND 2. Battery (+) 3. GND 4. Battery (+) 5. Power Coil 6. Power Coil 7. Power Coil</p>	2404 Honda CBR RR 929 2001 2003 31600-MCJ-641 Honda CBR RE 929 2001 2003 31600-MCJ-641 Reem lazo Shin ngen SH678C-13 2414 Honda CBR RR 600 2003 31600-MEE-003 Honda CBR RR 600 2004 2006 31600-MEE-872
产品单重	310克			
检测程序	M325 2404 2414			
电线插头	40CM			
内盒尺寸	12*9.5*6CM			
外箱尺寸	49.5*25.5*30.5CM			
输出电压	14.5±0.5V 35安培			
一箱只数	50			
铝壳尺寸				
重要说明				
产品编号	R2027.22.2		 <p>1. Battery (+) 2. GND 3. Battery (+) 4. GND 5. Power Coil 6. Power Coil 7. Power Coil</p>	2404 Honda CBR RR 929 2001 2003 31600-MCJ-641 Honda CBR RE 929 2001 2003 31600-MCJ-641 Reem lazo Shin ngen SH678C-13 2414 Honda CBR RR 600 2003 31600-MEE-003 Honda CBR RR 600 2004 2006 31600-MEE-872
产品单重	310克			
检测程序	M325 2404 2414			
电线插头	40CM			
内盒尺寸	12*9.5*6CM			
外箱尺寸	49.5*25.5*30.5CM			
输出电压	14.5±0.5V 35安培			
一箱只数	50			
铝壳尺寸				
重要说明				
产品编号	R2027.24		 <p>1. Battery (+) / Batería (+) 2. GND / Masa 3. Power Coil / Bobina de Carga 4. Power Coil / Bobina de Carga 5. Power Coil / Bobina de Carga 6. Field Coil / Bobina de Campo 7. Ignition Switch / Sensor</p>	2412 YamahaXS1100 1978 1981T4-81960-A0-00 YamahaXS850 1980 1981T4-81960-A0-00 YamahaXS75019781T4-81960-92-00 YamahaXS85019801T4-81960-92-00 YamahaXS750 1977 19791T4-81960-A0-00 YamahaXS1100 1979 19801T4-81960-92-00 YamahaXS265019771T4-81960-92-00 YamahaXS265019771J7-81970-60-00
产品单重	310克			
检测程序	CB750+励磁 2412			
电线插头	35CM			
内盒尺寸	12*9.5*6CM			
外箱尺寸	49.5*25.5*30.5CM			
输出电压	14.5±0.5V 25安培			
一箱只数	50			
铝壳尺寸				
重要说明				

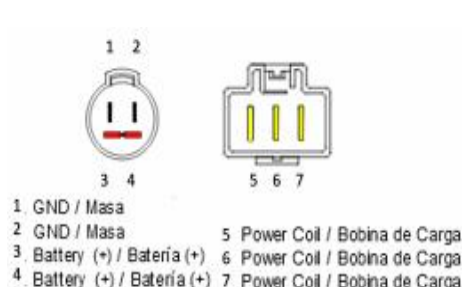

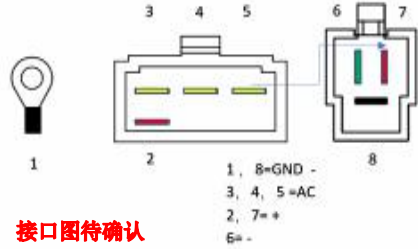

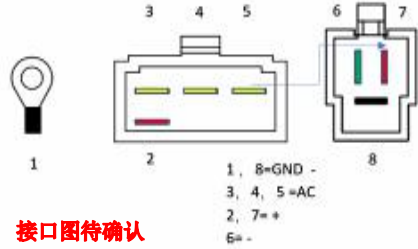
产品资料1		实物主图	接口图	适用范围
产品编号	R2027.25		 <p>1. Battery (+) 2. GND 3. Battery (+) 4. GND 5. Power Coil 6. Power Coil 7. Power Coil</p>	2404 Honda CBR RR 929 2001 2003 31600-MCJ-641 Honda CBR RE 929 2001 2003 31600-MCJ-641 Reem lazo Shin ngen SH678C-13 2414 Honda CBR RR 600 2003 31600-MEE-003 Honda CBR RR 600 2004 2006 31600-MEE-872
产品单重	310克			
检测程序	M325 2404 2414			
电线插头	25 35CM			
内盒尺寸	12*9.5*6CM			
外箱尺寸	49.5*25.5*30.5CM			
输出电压	14.5±0.5V 35			
一箱只数	50			
铝壳尺寸				
重要说明				
产品编号	R2027.26		 <p>1. Battery (+) / Bateria (+) 2. GND / Masa 3. Battery (+) / Bateria (+) 4. GND / Masa 5. Power Coil / Bobina de Carga 6. Power Coil / Bobina de Carga 7. Power Coil / Bobina de Carga</p>	Ducati Multistrada 1000 ESR538
产品单重	310克			
检测程序	325			
电线插头	1525CM			
内盒尺寸	12*9.5*6CM			
外箱尺寸	49.5*25.5*30.5CM			
输出电压	14.5±0.5V			
一箱只数	50			
铝壳尺寸				
重要说明				
产品编号	R2027.27		 <p>1. Battery (+) / Bateria (+) 2. GND / Masa 3. Battery (+) / Bateria (+) 4. GND / Masa 5. Power Coil / Bobina de Carga 6. Power Coil / Bobina de Carga 7. Power Coil / Bobina de Carga</p>	Ducati 54040261A Ducati 54040101A Ducati 54040111A Ducati 54040131A Ducati Hy ermotard EVO 1100 2010 2012 54040111C Ducati Hy ermotard 796 2010 2012 54040111C Ducati Hy ermotard 1100 2011 2012 54040111C Ducati Hy ermotard S / S 1100
产品单重	310克			
检测程序	325 2551			
电线插头	35CM			
内盒尺寸	12*9.5*6CM			
外箱尺寸	49.5*25.5*30.5CM			
输出电压	14.5±0.5V 35安培			
一箱只数	50			
铝壳尺寸				
重要说明	3条套管			
产品编号	R2027.28		 <p>1. GND / Masa 2. Battery (+) / Bateria (+) 3. Power Coil / Bobina de Carga 4. Power Coil / Bobina de Carga 5. Power Coil / Bobina de Carga</p>	Kawasaki KLX R / SR 400 s 2004 21066-S005 Reem lazo Shin ngen SH572E-12 Suzuki DR-Z S 400 2000 2017 32800-29F00 Suzuki DR-Z 400 2000 2004 32800-08D00 Suzuki DR-Z E 400 2004 2007 32800-29F00 Suzuki RM X 250 1998 1999 32800-08D00
产品单重	310克			
检测程序	325			
电线插头	25CM			
内盒尺寸	12*9.5*6CM			
外箱尺寸	49.5*25.5*30.5CM			
输出电压	14.5±0.5V			
一箱只数	50			
铝壳尺寸				
重要说明				

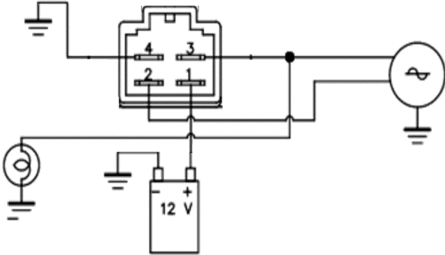

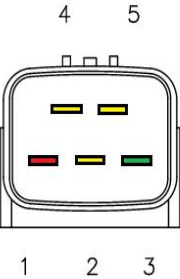

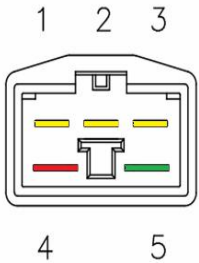

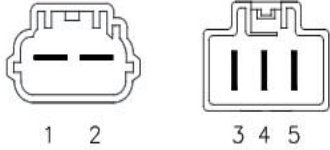
产品资料1		实物主图	接口图	适用范围
产品编号	R2027.29			1998-1999 Kawasaki Zx-9R Ninja Regulator/Rectifier Kawasaki Zx-9R (98-99) ESR840 1998-1999 KAWASAKI ZX-9R Ninja REGULATOR/RECTIFIER KAWASAKI ZX-9R (98-99)
产品单重	310克			
检测程序	325			
电线插头	25CM			
内盒尺寸	12*9.5*6CM			
外箱尺寸	49.5*25.5*30.5CM			
输出电压	14.5±0.5V			
一箱只数	50			
铝壳尺寸				
重要说明				
产品编号	R2027.30		 <p>1. GND / Masa 2. Ignition Switch / Sensor 3. Battery (+) / Batería (+) 4. Power Coil / Bobina de Carga 5. Power Coil / Bobina de Carga 6. Power Coil / Bobina de Carga 7. Power Coil / Bobina de Carga</p>	1998-1999 Kawasaki Zx-9R Ninja Regulator/Rectifier Kawasaki Zx-9R (98-99) ESR840 1998-1999 KAWASAKI ZX-9R Ninja REGULATOR/RECTIFIER KAWASAKI ZX-9R (98-99)
产品单重	310克			
检测程序	325			
电线插头	25CM			
内盒尺寸	12*9.5*6CM			
外箱尺寸	49.5*25.5*30.5CM			
输出电压	14.5±0.5V			
一箱只数	50			
铝壳尺寸				
重要说明				
产品编号	R2027.31		 <p>1. Battery (+) 2. GND 3. Power Coil 4. Power Coil 5. Power Coil</p>	Heritage Softail 1450 Classic - FLSTC1450 2001-06 Heritage Softail 1450 Classic EFI - FLSTC1450 2001-06 Heritage Softail 1450 EFI - FLSTI1450 2006 Heritage Softail 1450 S ringer - FLSTS1450 2001-03 Heritage Softail 1450 S ringer EFI - FLSTSI1450 01-03 Screaming Eagle Fat Boy 1690 -
产品单重	310克			
检测程序	M325			
电线插头	所有1.5 X 25 红黑40CM			
内盒尺寸	12*9.5*6CM			
外箱尺寸	49.5*25.5*30.5CM			
输出电压	14.5±0.5V			
一箱只数	50			
铝壳尺寸				
重要说明				
产品编号	R2027.32		 <p>1. Power Coil 2. Ignition Switch 3. Power Coil 4. Battery (+) 5. Power Coil 6. GND</p>	Kawasaki KLF 4x4 400 de 1993 a 1999 21066-1078 Kawasaki KLF Bayou 400 de 1996 a 1999 21066-1078 Kawasaki KVF raire 400 de 1997 a 1998 21066-1078 Reem lazo Shindengen SH541E-12
产品单重	310克 净重290			
检测程序	M325			
电线插头	红黄绿1.5 X 20CM			
内盒尺寸	12*9.5*6CM			
外箱尺寸	49.5*25.5*30.5CM			
输出电压	14.5±0.5V			
一箱只数	50			
铝壳尺寸				
重要说明				

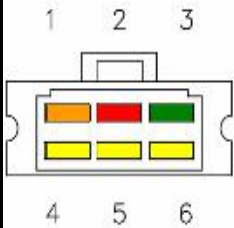

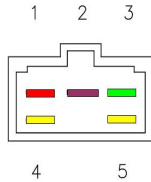

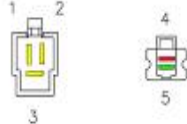

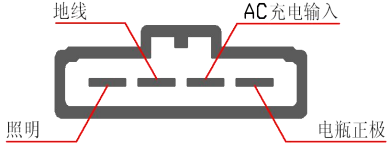
产品资料1		实物主图	接口图	适用范围
产品编号	R2027.33		 <p>1. Ignition Switch/ Sensor 2. Battery (+) / Bateria (+) 3. GND / Masa</p> <p>4. Power Coil / Bobina de Carga 5. Power Coil / Bobina de Carga 6. Power Coil / Bobina de Carga</p>	Honda NX650 Dominator NX 650 1988-1994 31600-MY2-621
产品单重	330克			
检测程序	325			
电线插头	35CM			
内盒尺寸	12*9.5*6CM			
外箱尺寸	49.5*25.5*30.5CM			
输出电压	14.5±0.5V			
一箱只数	50			
铝壳尺寸				
重要说明				
产品编号	R2027.34		 <p>1. Battery (+) / Bateria (+) 2. Battery (+) / Bateria (+) 3. Battery (-) / Bateria (-) 4. Battery (-) / Bateria (-)</p> <p>5. Power Coil / Generado 6. Power Coil / Generado 7. Power Coil / Generado</p>	Voltage Regulator RectifierPolaris redator Outlaw 500 ATV 2003-2007
产品单重	330克			
检测程序	325			
电线插头	25CM			
内盒尺寸	12*9.5*6CM			
外箱尺寸	49.5*25.5*30.5CM			
输出电压	14.5±0.5V			
一箱只数	50			
铝壳尺寸				
重要说明				
产品编号	R2027.35			
产品单重	克			
检测程序	325			
电线插头	25CM			
内盒尺寸	12*9.5*6CM			
外箱尺寸	49.5*25.5*30.5CM			
输出电压	14.5±0.5V			
一箱只数	50			
铝壳尺寸				
重要说明				
产品编号	R2027.36			KAWASAKI ZX-6R 600 NINJA 21066-0025
产品单重	克			
检测程序	M325			
电线插头	黑1.5 X 20 30CM			
内盒尺寸	12*9.5*6CM			
外箱尺寸	49.5*25.5*30.5CM			
输出电压	14.5±0.5V			
一箱只数	50			
铝壳尺寸				
重要说明				

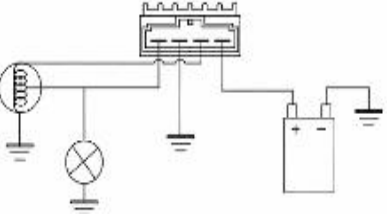

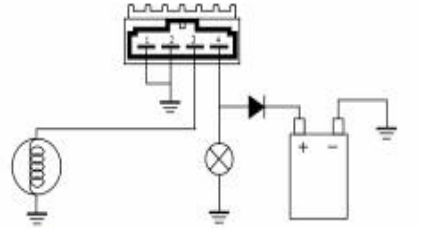

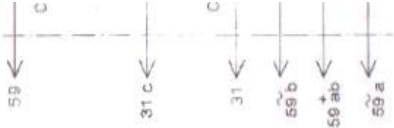

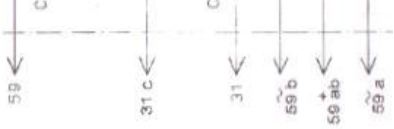
产品资料1		实物主图	接口图	适用范围
产品编号	R2027.37			KAWASAKI ZX-6R 600 NINJA 21066-0025
产品单重	克			
检测程序	325			
电线插头	35CM			
内盒尺寸	12*9.5*6CM			
外箱尺寸	49.5*25.5*30.5CM			
输出电压	14.5±0.5V			
一箱只数	50			
铝壳尺寸				
重要说明				
产品编号	R2027.38			Regolatore Electros ort V834200241 er Suzuki GS 750 1981 1982 1983
产品单重	克			
检测程序	325			
电线插头	15 25CM			
内盒尺寸	12*9.5*6CM			
外箱尺寸	49.5*25.5*30.5CM			
输出电压	14.5±0.5V			
一箱只数	50			
铝壳尺寸				
重要说明				
产品编号	R2027.39			Suzuki 02162-0620C Suzuki 32800-10G00 Suzuki 32800-10G10 Suzuki 32800-10G20 Suzuki 32800-10G30 Suzuki AN650 Burgman 650 2003-2012 Suzuki AN650Z Burgman 650 2008 Suzuki VLR1800 Intru r C1800R 2008-2015 Suzuki VLR1800 Boulevard C109R 2008-2015
产品单重	净重320克			
检测程序	M325			
电线插头	所有1.5 X 25 CM			
内盒尺寸	12*9.5*6CM			
外箱尺寸	49.5*25.5*30.5CM			
输出电压	14.5±0.5V			
一箱只数	50			
铝壳尺寸				
重要说明				
产品编号	R2027.40			Suzuki AN400 Burgman 2008 400cc 32800-05H10 32800-05H11
产品单重	克			
检测程序	M325			
电线插头	所有1.5 X 25 CM			
内盒尺寸	12*9.5*6CM			
外箱尺寸	49.5*25.5*30.5CM			
输出电压	14.5±0.5V			
一箱只数	50			
铝壳尺寸				
重要说明	一般用黑色4 插			

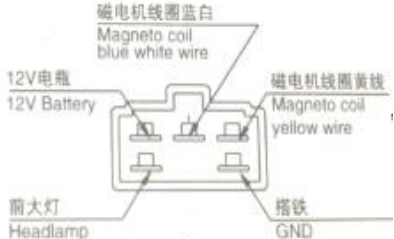

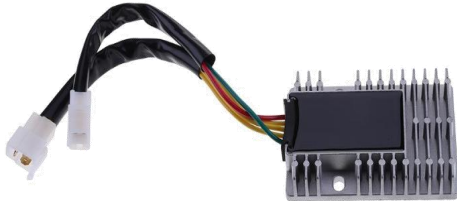
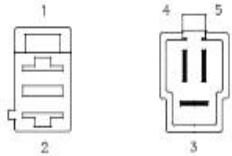

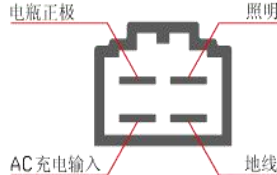
产品资料1		实物主图	接口图	适用范围
产品编号	R2027.41		 <p>接口图待确认</p>	Suzuki GT380 GT550 GT750 1972-1976 32800-31021 32800-37010
产品单重	克			
检测程序	M325			
电线插头	所有1.5 X 25 黑线30CM			
内盒尺寸	12*9.5*6CM			
外箱尺寸	49.5*25.5*30.5CM			
输出电压	14.5±0.5V			
一箱只数	50			
铝壳尺寸				
重要说明				
产品编号	R2027.42		 <p>接口图待确认</p>	±012A.
产品单重	净重 320 克			
检测程序	M325			
电线插头	所有1.5 X 25 60CM 短红线10CM			
内盒尺寸	12*9.5*6CM			
外箱尺寸	49.5*25.5*30.5CM			
输出电压	14.5±0.5V			
一箱只数	50			
铝壳尺寸				
重要说明				
产品编号	R2028.0		<p>7048A-6.3-11</p> 	03-ETON-50-70-90 0450553 0452061 ATV YAMAHA JOG 50 YAMAHA ZUMA 50 70CC E-Ton AXL 50 Lightning 2000-2001 E-Ton AXL 90 Lightning 2 Stroke E-Ton DXL 90 Sierra 2 Stroke 2000-2005 E-Ton RXL 50 Vi er 2002-2004 E-Ton RXL 70 Vi er 2 Stroke 2004-2007 E-Ton RXL 90 Vi er 2 Stroke 2002-2003, 2005-2007
产品单重	65克			
检测程序	HS08 半波			
电线插头	4针插头			
内盒尺寸	100*85*30MM			
外箱尺寸	49.5*25.5*30.5CM			
输出电压	14.5±0.5V			
一箱只数	50			
铝壳尺寸				
重要说明				
产品编号	R2029.0		 <p>1. Battery (+) 2. Power Coil 3. GND 4. Power Coil 5. Power Coil</p>	Honda ATV OEM 31600-HP6-A01 Honda TRX700XX TRX700 2008-2009 Honda Aquatrax F-12X F-12 R-12X R-12 WC 31600-HW1-671 Kawasaki KLE 650 SH868AA Kawasaki Ninja/Vulcan S/Versys/Z 650 2017-2019 OEM 21066-0750 EN650 / ER650 / EX650 / KLE650 / Z650
产品单重	250克			
检测程序	M325			
电线插头	5针插头			
内盒尺寸	12*9.5*6CM			
外箱尺寸	49.5*25.5*30.5CM			
输出电压	14.5±0.5V			
一箱只数	50			
铝壳尺寸				
重要说明				

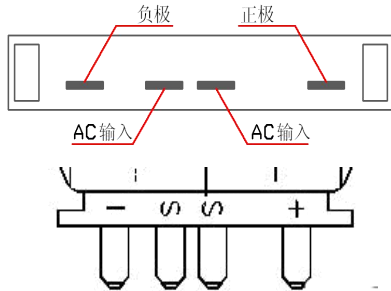

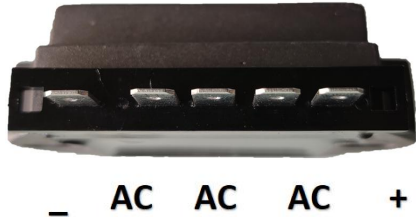

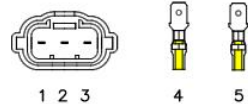

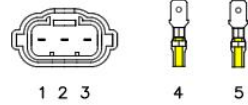
产品资料1		实物主图	接口图	适用范围
产品编号	R2029.1		 <p>1. Power Coil 2. Power Coil 3. Power Coil 4. Battery (+) 5. GND</p>	YHC125/ 31600-KVK-901 SH781AA Honda CBR250R CBR250 2011-2015 Honda CBR300R CBR300 2014-2015 Honda CRF250L AC CRF250 2013-2014
产品单重	净重265克			
检测程序	M325			
电线插头	5针插头			
内盒尺寸	12*9.5*6CM			
外箱尺寸	49.5*25.5*30.5CM			
输出电压	14.5±0.5V			
一箱只数	50			
铝壳尺寸				
重要说明				
产品编号	R2029.2		 <p>1. Battery (+) / Bateria (+) 2. GND / Masa 3. Power Coil / Bobina de Carga 4. Power Coil / Bobina de Carga 5. Power Coil / Bobina de Carga</p>	SUZUKI AN Burgman 650 2008 2009 2010 2011 2012 SUZUKI AN BURGMAN 650 2010 - 2010 SUZUKI AN BURGMAN 650 2011 - 2012 SUZUKI VL INTRU R 1500 2013 - 2013 SUZUKI VZR INTRU R M 1800 2006 - 2014
产品单重	净重 312克			
检测程序	M325			
电线插头	所有1.5 X 20CM			
内盒尺寸	12*9.5*6CM			
外箱尺寸	49.5*25.5*30.5CM			
输出电压	14.5±0.5V			
一箱只数	50			
铝壳尺寸				
重要说明	都做成黑线			
产品编号	R2029A.0			Honda TRX 400 Rancher -- 2004-2006 Honda TRX 450 Fourtrax Foreman FE -- 2002-2004 Honda TRX 450 Fourtrax Foreman FM -- 2002-2004 31600-HN0-670 31600-HN0-671 31600-HN7-003 515176699 21066-0750 21066-0761
产品单重	净重 312克			
检测程序	M325			
电线插头	所有1.5 X 20CM			
内盒尺寸	12*9.5*6CM			
外箱尺寸	49.5*25.5*30.5CM			
输出电压	14.5±0.5V			
一箱只数	50			
铝壳尺寸				
重要说明	都做成黑线			
产品编号	R2031.0		 <p>1. Ignition Switch 2. Battery (+) 3. GND 4. Power Coil 5. Power Coil 6. Power Coil</p>	2068 25A Kawasaki - 21066-1028 Kawasaki BJ Estrella 250 1994 21066- 1030 Kawasaki EL Eliminator 250 1988 2003 21066-1030 Kawasaki EL HS 250 1991 1994 21066- 1030 Kawasaki EN LTD 454 1985 1990 21066-1030 Kawasaki EN Vulcan 400 1989 1994
产品单重	250克			
检测程序	315 2077 2068			
电线插头	20CM			
内盒尺寸	12*9.5*6CM			
外箱尺寸	49.5*25.5*30.5CM			
输出电压	14.5±0.5V 25安培			
一箱只数	50			
铝壳尺寸				
重要说明				

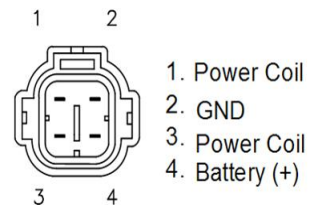
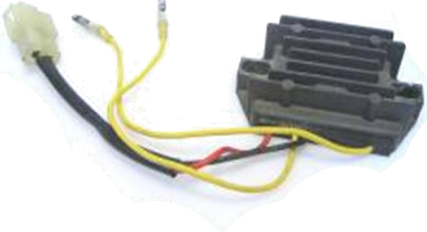
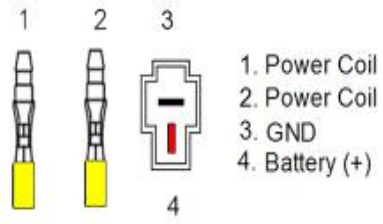

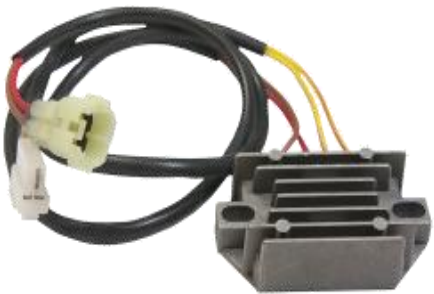

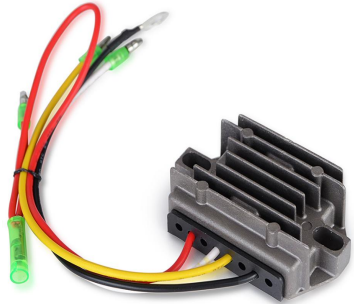
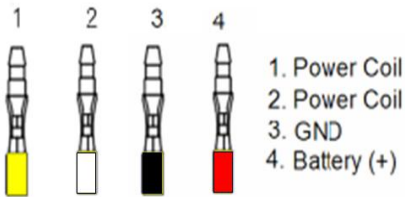
产品资料1		实物主图	接口图	适用范围
产品编号	R2031.1		 <p>1. Battery (+) / Bateria (+) 2. Ignition Switch / Sensor 3. GND / Masa 4. Power Coil / Bobina de Carga 5. Power Coil / Bobina de Carga</p>	HONDA GX610 18H HONDA GX620 20H HONDA GX670 24H 10A
产品单重	220			
检测程序	215			
电线插头	5针插头			
内盒尺寸	100*85*30MM			
外箱尺寸	49.5*25.5*30.5CM			
输出电压	14.5±0.5V 10A			
一箱只数	50			
铝壳尺寸				
重要说明				
产品编号	R2031.2		 <p>1. Power Coil / Bobina de Carga 2. Power Coil / Bobina de Carga 3. Power Coil / Bobina de Carga 4. Battery (+) / Bateria (+) 5. GND / Masa</p>	SUZUKI EN125
产品单重				
检测程序	315			
电线插头	20CM			
内盒尺寸	12*9.5*6CM			
外箱尺寸	49.5*25.5*30.5CM			
输出电压	14.5±0.5V			
一箱只数	50			
铝壳尺寸				
重要说明				
产品编号	R2032.0			XH90 单相半波稳压器(单管、双管) Honda CBF 600 SA8 (2008) KTM Ark 50 LC K / Go 50 Chrono 502 / Kross 50 SUZUKI Akira Young KAWASAKI Tuxedo 西湖90 印王90 JOG 雅马哈 风帆 XH-90 雅马哈JOG50 JOG90 南方50整流器
产品单重				
检测程序	HS08 半波			
电线插头				
内盒尺寸	100*85*30MM			
外箱尺寸	49.5*25.5*30.5CM			
输出电压	14.5±0.5V			
一箱只数	50			
铝壳尺寸				
重要说明				
产品编号	R2032.2			2350 8A Marca Mo lo Versión Cilindrada Año Cod. OEM Aprilia Amico 50 1992 1995 A 8212540 Aprilia Amico 50 1996 1998 A 8212540 Aprilia Area 51 50 1998 2000 A 8212540 Aprilia Gulliver 50 1995 1998 A 8212540
产品单重				
检测程序	半波HS08 2052 2350 2015 2016			
电线插头				
内盒尺寸	100*85*30MM			
外箱尺寸	49.5*25.5*30.5CM			
输出电压	14.5±0.5V 12安培-8A			
一箱只数	50			
铝壳尺寸				
重要说明				

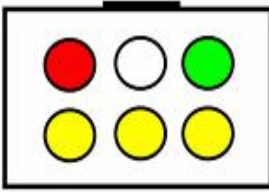

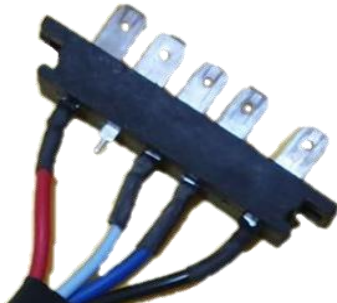

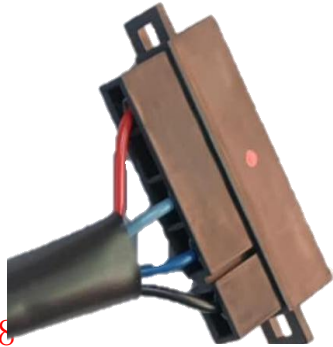

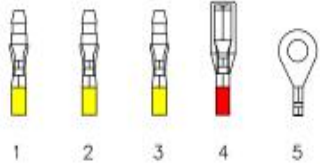
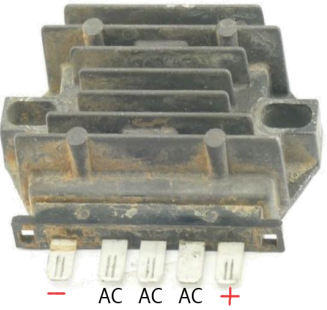
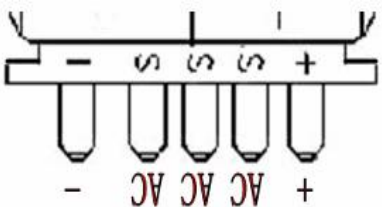
产品资料1		实物主图	接口图	适用范围
产品编号	R2032.3		 <p>1. GND / Masa 3. Power Coil / Bobina de Carga 2. GND / Masa 4. Regulated AC out / Salida AC Regulada</p>	2411 Ducati- 434848110 MBKX-limitEnduro / Super Motard50 2003 20061D4-H3598-00 MalagutiCNKDrakon50 2005 2008 02602100 MalagutiXSM50 2003 200602602100 MalagutiXTM50 2003 200602602100 YamahaDTR / SM / X50 2003 20061D4-H3598-00
产品单重				
检测程序	半波HS08 2411			
电线插头				
内盒尺寸	100*85*30MM			
外箱尺寸	49.5*25.5*30.5CM			
输出电压	14.5±0.5V 20安培			
一箱只数	50			
铝壳尺寸				
重要说明				
产品编号	R2033.0	 		白天电流12.2V 晚上电流14V 负载 2.5A 德国Simson(西姆松)摩托车/ Application: Alternating Volt.S51 S70 SR50 Simson Alternating Volt. Regulator Ewr 8107.10 S51 S70 SR50 SR80 S53 S83 Roller 申明: 本产品是为客户专门制定的产品, 有特定的商标, 只做展示用, 以证明本公司的开发能力。
产品单重	130克一箱=100只=13.4KG			
检测程序				
电线插头				
内盒尺寸	80X 50X 70MM			
外箱尺寸				
输出电压	一箱=100只=13.4KG			
一箱只数				
铝壳尺寸				
重要说明				
产品编号	R2033.1	 		白天电流12.2V 晚上电流14V 负载 2.5A 德国Simson(西姆松)摩托车/ Application: Alternating Volt.S51 S70 SR50 Simson Alternating Volt. Regulator Ewr 8107.10 S51 S70 SR50 SR80 S53 S83 Roller 申明: 本产品是为客户专门制定的产品, 有特定的商标, 只做展示用, 以证明本公司的开发能力。
产品单重	130克			
检测程序				
电线插头				
内盒尺寸	80X 50X 70MM			
外箱尺寸				
输出电压				
一箱只数	一箱=100只=13.4KG			
铝壳尺寸				
重要说明				
产品编号	R2034.0			/BAJAJ CT100/ Application: BOXER BM100 Classic, BAJAJ LATINO S ORT100CC CT100TEC/SID Bajaj boxer CT100
产品单重				
检测程序	215			
电线插头	15CM			
内盒尺寸	12*9.5*6CM			
外箱尺寸	49.5*25.5*30.5CM			
输出电压	14.5±0.5V			
一箱只数	50			
铝壳尺寸				
重要说明				

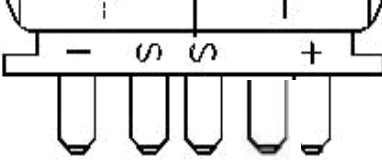

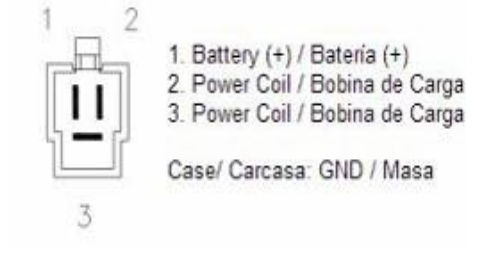

产品资料1		实物主图	接口图	适用范围
产品编号	R2036.0		 <p>1. Battery (+) / Bateria (+) 2. GND / Masa 3. Power Coil / Bobina de Carga 4. Power Coil / Bobina de Carga 5. Power Coil / Bobina de Carga</p>	2545 Kymco 光阳 Downtown 200 2011 2014 31600-KED9-900 Kymco Downtown 125 2009 2011 31600-KED9-900 Kymco Downtown 300 2009 2015 31600-KED9-900 Kymco eo 1e 300 2008 2014 31600-KED9-900 Kymco eo 1e 125 2009 2011 31600-KED9-900
产品单重	290克			
检测程序	325 2545 2599			
电线插头	25CM			
内盒尺寸	12*9.5*6CM			
外箱尺寸	49.5*25.5*30.5CM			
输出电压	14.5±0.5V 35安培			
一箱只数	50			
铝壳尺寸				
重要说明				
产品编号	R2037.0		 <p>电瓶正极 照明 AC充电输入 地线</p>	CY80 嘉陵JH70金城70本田鹰仔 K90CY80AX100 RX125摩托车6V整流器稳压器
产品单重				
检测程序	半波HS08			
电线插头				
内盒尺寸	100*85*30MM			
外箱尺寸	49.5*25.5*30.5CM			
输出电压	14.5±0.5V			
一箱只数	50			
铝壳尺寸				
重要说明				
产品编号	R2038.0		 <p>负极 正极 AC输入 AC输入</p>	中华厦杏ZH125 ZH125A ; YAMAHA RD350 SUZUKI REGULATOR RECTIFIER GR650 GS700 GS750 GS1150 1982-1986 SUZUKI 32800-44130 GR650 GR 650 TEM TER 1983 GS700 GS 700 E 1984-1985 GS700 GS 700 ES 1984-1985 GS750 GS 750 E 1983 GS1000 GS 1000 SZ KATANA 1982 GS1100 GS 1100 G 1984 GS1100 GS 1100 GK 1983-1984
产品单重	100克			
检测程序	215			
电线插头				
内盒尺寸	100*85*30MM			
外箱尺寸	49.5*25.5*30.5CM			
输出电压	14.5±0.5V			
一箱只数	50			
铝壳尺寸				
重要说明				
产品编号	R2038.0A		 <p>- AC AC AC +</p>	Cagiva Mito 125 8 Bj.1998 - S annungsregler Gleichrichter GS1000 GS 1000 SZ KATANA 1982 GS1100 GS 1100 G 1984 GS1100 GS 1100 GK 1983-1984 GS1150 GS 1150 E 1984-1986 GS1150 GS 1150 ES 1984-1986 ; BRAND NEW REGULATOR RECTIFIER UNIT YAMAHA RD350 BIKES 32800-44230
产品单重	净重107克			
检测程序	M325			
电线插头				
内盒尺寸	100*85*30MM			
外箱尺寸	49.5*25.5*30.5CM			
输出电压	14.5±0.5V			
一箱只数	50			
铝壳尺寸				
重要说明				

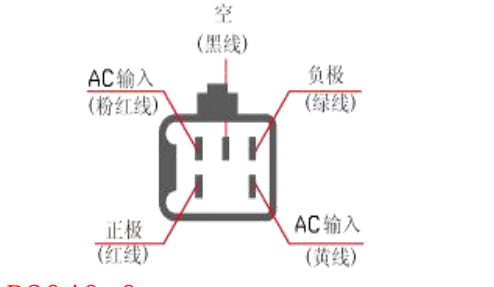

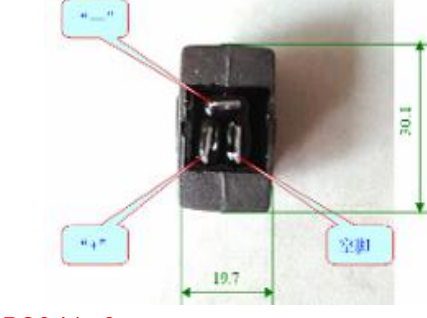

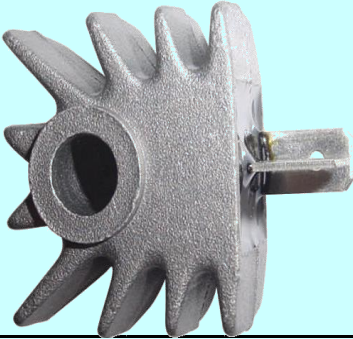
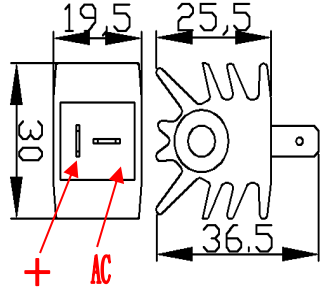

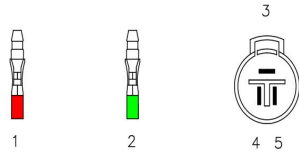
产品资料1		实物主图	接口图	适用范围
产品编号	R2038.1		 <p>1. Control Relay / Relé de Control 2. Battery (+) / Batería (+) 3. GND / Masa</p> <p>4. Power Coil / Bobina de Carga 5. Power Coil / Bobina de Carga</p> <p>1白线是触发释放功能=控制继电器; 4 5 交流出二极管负极线 2红线 电瓶 正极 3绿线负极或接</p>	KTM 77211034000 KTM 450sx-f/250xc-f/250sx-f/350sx-f 2011-2017 KTM 250 SX-F FABRIEK EDITIE 2015-2017 KTM 450 SX-F FABRIEK EDITIE 2012-2017 KTM 250 SX-F ROCZEN REPLICA 2012 KTM 250 SX-F MUSQUIN REPLICA 2011-2017 KTM 350 SX-F CAIROLI REPLICA 2011-2012 KTM 350 XC-F 2011-2017
产品单重	127 净重110克			
检测程序	215 2569			
电线插头	25CM			
内盒尺寸	12*9.5*6CM			
外箱尺寸	49.5*25.5*30.5CM			
输出电压	14.5±0.5V			
一箱只数	50			
铝壳尺寸				
重要说明				
产品编号	R2038A.1		 <p>1. Control Relay / Relé de Control 2. Battery (+) / Batería (+) 3. GND / Masa</p> <p>4. Power Coil / Bobina de Carga 5. Power Coil / Bobina de Carga</p> <p>1白线是触发释放功能=控制继电器; 4 5 交流出二极管负极线 2红线 电瓶 正极 3绿线负极或接</p>	Husqvarna FC 250 de 2014 a 2020 77211034000 Husqvarna FC 450 de 2014 a 2020 77211034000 Husqvarna FC Rockstar Edition 450 de 2018 a 2019 77211034000 Husqvarna FC 350 de 2014 a 2020 77211034000 Husqvarna FS 450 de 2015 a 2020 77211034000 Husqvarna FX 450 de 2017 a 2020
产品单重	127 净重110克			
检测程序	215 2569			
电线插头	25CM			
内盒尺寸	12*9.5*6CM			
外箱尺寸	49.5*25.5*30.5CM			
输出电压	14.5±0.5V			
一箱只数	50			
铝壳尺寸				
重要说明	注意 铝壳不一样			
产品编号	R2038A.2		 <p>1. Power Coil 2. GND 3. Power Coil 4. Battery (+)</p>	2008-2014 SUZUKI Rectifier Regulator RMZ 250 RM-Z RMZ450 RMZ250 32800-28H00 B 2008-2013 SUZUKI Regulator Rectifier RMZ 250 RM-Z RMZ250 RMZ450 KTM 250SXF 250 SXF 350 450 charging regulator rectifier 20 胡思瓦纳 Husqvarna TC250R TC250 TC 250 charging regulator rectifier 3 Arctic Cat 440 Sno ro F6 600 Sno ro Carb L/C 2004-2008 OEM Re 1. #
产品单重	127			
检测程序	215			
电线插头	30CM			
内盒尺寸	12*9.5*6CM			
外箱尺寸	49.5*25.5*30.5CM			
输出电压	14.5±0.5V			
一箱只数	50			
铝壳尺寸				
重要说明				
产品编号	R2038A.3		 <p>1. Power Coil 2. Power Coil 3. GND 4. Battery (+)</p>	胡思瓦纳 HUSQVARNA 05 TC250 TC 250 2005
产品单重	盒127克 净重103克			
检测程序	215			
电线插头	25CM			
内盒尺寸	12*9.5*6CM			
外箱尺寸	49.5*25.5*30.5CM			
输出电压	14.5±0.5V			
一箱只数	50			
铝壳尺寸				
重要说明				

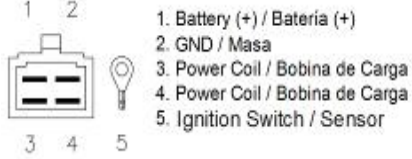

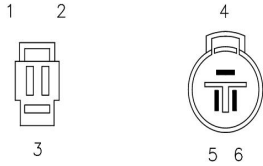

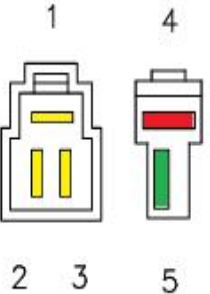

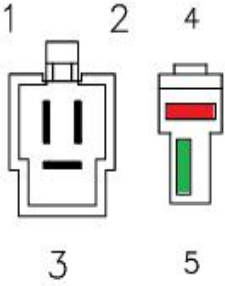
产品资料1		实物主图	接口图	适用范围
产品编号	R2038A.4			2001 Arctic Cat Mountain Cat 600 VEV 2001 Arctic Cat Tri le Touring 660 -- 2000 Arctic Cat ZR 440 Sno ro 2001 Arctic Cat ZR 600 EFI 2001 Arctic Cat ZR 600 VEV 2002 Arctic Cat ZRT 600 -- 2001 Arctic Cat ZRT 600 -- 2001 Arctic Cat ZRT 600 Limited SM-01133
产品单重	127			
检测程序	215			
电线插头	50CM			
内盒尺寸	12*9.5*6CM			
外箱尺寸	49.5*25.5*30.5CM			
输出电压	14.5±0.5V			
一箱只数	50			
铝壳尺寸				
重要说明				
产品编号	R2038A.5			Nissan Tohatsu 90h outboard NS90A m90a Rectifier regulator 东发船外机70马力二冲整流器 SU204Y-2 3B7-76065-3 853811003 3B7-76060-3 3B7-76065-1 3B7-76065-2 3B7-76065-4 3B7-76060-0 3B7-76060-1 3B7-76060-3
产品单重	净重102克			
检测程序	215			
电线插头	8 25 40CM			
内盒尺寸	12*9.5*6CM			
外箱尺寸	49.5*25.5*30.5CM			
输出电压	14.5±0.5V			
一箱只数	50			
铝壳尺寸				
重要说明				
产品编号	R2038A.6			2013 Kawasaki KXF 250 KX 250F used Voltage Regulator Rectifier 21066- 0721 2013-2016 Kawasaki KX250F or 2012-2015 KX450F
产品单重	净重135克			
检测程序	308			
电线插头	25CM			
内盒尺寸	12*9.5*6CM			
外箱尺寸	49.5*25.5*30.5CM			
输出电压	14.5±0.5V			
一箱只数	50			
铝壳尺寸				
重要说明				
产品编号	R2038A.7			久保田 整流器 YANMAR
产品单重				
检测程序	168F			
电线插头	20CM			
内盒尺寸	12*9.5*6CM			
外箱尺寸	49.5*25.5*30.5CM			
输出电压	14.5±0.5V			
一箱只数	50			
铝壳尺寸				
重要说明				





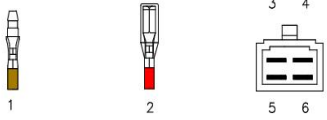

产品资料1		实物主图	接口图	适用范围
产品编号	R2038A.8			久保田 整流器 rectifier regulator Kubota YANMAR
产品单重	净重100克			
检测程序	168F			
电线插头	20 CM			
内盒尺寸	12*9.5*6CM			
外箱尺寸	49.5*25.5*30.5CM			
输出电压	14.5±0.5V			
一箱只数	50			
铝壳尺寸				
重要说明				
产品编号	R2038A.9		 <ol style="list-style-type: none"> 1. Power Coil / Bobina de Carga (Yellow/ Amarillo) 2. Power Coil / Bobina de Carga (Yellow/ Amarillo) 3. Power Coil / Bobina de Carga (Yellow/ Amarillo) 4. Battery (+) / Bateria (+) 5. GND/ Masa 	Reem lazo Shindengen SH590A-13 Suzuki 32800-47121 Suzuki 32800-49X50 Suzuki GS T 750 de 1982 a 1983 32800-47120 Suzuki GS E 650 de 1981 a 1982 32800-47020 Suzuki GS E 500 de 1982 a 1983 32800-47120 Suzuki GS 1000 1996 32800-45210 Suzuki GS EX 550 1981 32800-47020
产品单重	净重108克盒 重125克			
检测程序	M325 一平方线X 20 25CM			
电线插头	25CM			
内盒尺寸	12*9.5*6CM			
外箱尺寸	49.5*25.5*30.5CM			
输出电压	14.5±0.5V			
一箱只数	50			
铝壳尺寸				
重要说明				
产品编号	R2038A.11			Suzuki GS850G 1982 Reemplazo Shindengen SH590A-13 Suzuki 32800-47121 Suzuki 32800-49X50 Suzuki GS T 750 de 1982 a 1983 32800-47120 Suzuki GS E 650 de 1981 a 1982 32800-47020 Suzuki GS E 500 de 1982 a 1983 32800-47120 Suzuki GS 1000 1996 32800-45210
产品单重	净重108克盒 重125克			
检测程序	M325			
电线插头	25CM			
内盒尺寸	12*9.5*6CM			
外箱尺寸	49.5*25.5*30.5CM			
输出电压	14.5±0.5V			
一箱只数	50			
铝壳尺寸				
重要说明				
产品编号	R2038A.11			Cagiva Mito 125 A566027520 A566012001
产品单重	净重108克盒 重125克			
检测程序	215			
电线插头	25CM			
内盒尺寸	12*9.5*6CM			
外箱尺寸	49.5*25.5*30.5CM			
输出电压	14.5±0.5V			
一箱只数	50			
铝壳尺寸				
重要说明				

产品资料1		实物主图	接口图	适用范围
产品编号	R2038A.12			B7001-6001-5001-7000-6000-5000 B1500-1502-1402 Kubota B1400 B1402 B1500 B1502 B5000 B5001 B6001 B7000 B7001 66611-55252 H6720-55200 H6620-55200
产品单重				
检测程序				
电线插头	12CM			
内盒尺寸	12*9.5*6CM			
外箱尺寸	49.5*25.5*30.5CM			
输出电压	14.5±0.5V			
一箱只数	50			
铝壳尺寸				
重要说明				
产品编号	R2039.0		 <p>1. Battery (+) / Bateria (+) 2. Power Coil / Bobina de Carga 3. Power Coil / Bobina de Carga Case/ Carcasa: GND / Masa</p>	10107 JiansheCY80 JiansheCYA80 Reem lazo ietcard1180 Reem lazo ietcard1013 YamahaRX10036L-H1960-V0
产品单重				
检测程序	HS08半波 10107			
电线插头	20CM			
内盒尺寸	100*85*30MM			
外箱尺寸	49.5*25.5*30.5CM			
输出电压	6V 8A			
一箱只数	50			
铝壳尺寸				
重要说明				
产品编号	R2040.0			BAJAJ CT100
产品单重	127			
检测程序	215			
电线插头	20CM			
内盒尺寸	100*85*30MM			
外箱尺寸	49.5*25.5*30.5CM			
输出电压	14.5±0.5V			
一箱只数	50			
铝壳尺寸				
重要说明				
产品编号	R2041.0			31750-735-013 Honda GX630GX660GX690 Double Cylinder 刺猬二极管 D10 (regulator/rectifier) 150cc Gas scooters, Chinese parts
产品单重	单重/克23.3			
检测程序	二极管			
电线插头				
内盒尺寸				
外箱尺寸				
输出电压				
一箱只数				
铝壳尺寸				
重要说明				



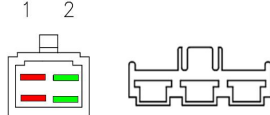

产品资料1		实物主图	接口图	适用范围
产品编号	R2041.1	 <p style="text-align: right; color: red; font-weight: bold;">2041.1</p>	 <p style="text-align: right; color: red; font-weight: bold;">R2041.1</p>	2041.1// Application: Honda MB 100
产品单重	单重/克23.3			
检测程序	二极管			
电线插头				
内盒尺寸				
外箱尺寸				
输出电压				
一箱只数				
铝壳尺寸				
重要说明				
产品编号	R2042.1	 <p style="text-align: right; color: red; font-weight: bold;">2041.1</p>	<p style="text-align: right; color: red; font-weight: bold;">R2042.1</p>	353-81970-M0-00 353-81970-63-00
产品单重				
检测程序	二极管			
电线插头				
内盒尺寸				
外箱尺寸				
输出电压				
一箱只数				
铝壳尺寸				
重要说明				
产品编号	R2043.0	 <p style="text-align: right; color: red; font-weight: bold;">R2043.0</p>	 <p style="text-align: right; color: red; font-weight: bold;">R2043.0</p>	2341 HondaTRXFourtrax300 1993 200031600- HC5-970 HondaTRXFourtrax FW300 1993 2000 31600-HC5-970 Reem lazoShin ngenSH532C-13
产品单重	240			
检测程序	315 2341			
电线插头	20 35CM			
内盒尺寸	12*9.5*6CM			
外箱尺寸	49.5*25.5*30.5CM			
输出电压	14.5±0.5V 25安培			
一箱只数	50			
铝壳尺寸				
重要说明				
产品编号	R2043.1	 <p style="text-align: right; color: red; font-weight: bold;">R2043.1</p>	 <p style="text-align: right; color: red; font-weight: bold;">R2043.1</p>	SUZUKI GN125ET GN125E 1991-1996
产品单重	240			
检测程序	315			
电线插头	20 35CM			
内盒尺寸	12*9.5*6CM			
外箱尺寸	49.5*25.5*30.5CM			
输出电压	14.5±0.5V			
一箱只数	50			
铝壳尺寸				
重要说明				

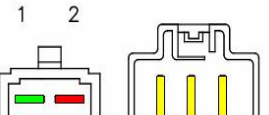

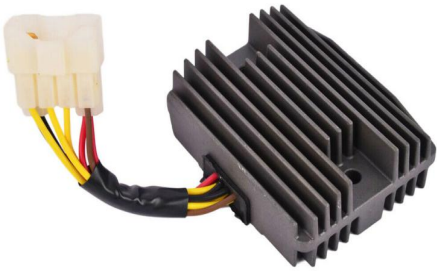
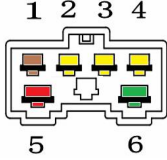

产品资料1		实物主图	接口图	适用范围
产品编号	R2043.2		 <p>1. Ignition Switch/ Sensor 2. Battery (+) / Batería (+) 3. GND / Masa</p> <p>4. Power Coil / Bobina de Carga 5. Power Coil / Bobina de Carga 6. Power Coil / Bobina de Carga</p>	Honda TRX Fourtrax 300 1988 1992 31600-HC4-010 / SH532B-12 Honda TRX Fourtrax FW 4x4 300 1988 31600-HC4-010 / SH532B-12 Honda TRX Fourtrax FW 4x4 300 1990 1992 31600-HC4-010 / SH532B-12
产品单重	230			
检测程序	315			
电线插头	黄线20 红绿黑35CM			
内盒尺寸	12*9.5*6CM			
外箱尺寸	49.5*25.5*30.5CM			
输出电压	14.5±0.5V			
一箱只数	50			
铝壳尺寸				
重要说明				
产品编号	R2043.3		 <p>1. Power Coil 2. Power Coil 3. Power Coil 4. Battery (+) 5. Battery (-)</p>	2466 Hyosung GT S / R FI 650 2007 2013 32800HN9101 Hyosung GT /R 250 2008 2013 32800HN9110 Hyosung GT /R FI 250 2010 2013 32800HN9110 Hyosung GV Mirage 650 2007 2013 32800HN9101 Hyosung GV Comet 650 2007 2013 32800HN9101
产品单重	240			
检测程序	315 2466			
电线插头	20CM			
内盒尺寸	12*9.5*6CM			
外箱尺寸	49.5*25.5*30.5CM			
输出电压	14.5±0.5V 35安培			
一箱只数	50			
铝壳尺寸				
重要说明				
产品编号	R2043.4		 <p>1. Power Coil 2. Power Coil 3. Power Coil 4. Battery (+) 5. Battery (-)</p>	2466 Hyosung GT S / R FI 650 2007 2013 32800HN9101 Hyosung GT /R 250 2008 2013 32800HN9110 Hyosung GT /R FI 250 2010 2013 32800HN9110 Hyosung GV Mirage 650 2007 2013 32800HN9101 Hyosung GV Comet 650 2007 2013 32800HN9101
产品单重	240			
检测程序	315 2466			
电线插头	20CM			
内盒尺寸	12*9.5*6CM			
外箱尺寸	49.5*25.5*30.5CM			
输出电压	14.5±0.5V 35安培			
一箱只数	50			
铝壳尺寸				
重要说明				
产品编号	R2043.5			汽油机整流器 通机整流器 4 线 科勒Kohler 14马力汽油发动机 CH440 Yanmar L40 L48 L60 L70 170F 178F
产品单重	240			
检测程序	168F			
电线插头	10 12 20CM			
内盒尺寸	12*9.5*6CM			
外箱尺寸	49.5*25.5*30.5CM			
输出电压	14.5±0.5V			
一箱只数	50			
铝壳尺寸				
重要说明				

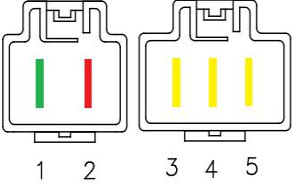
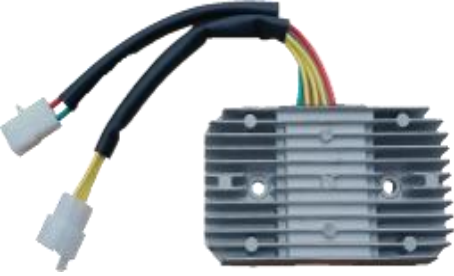
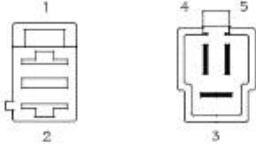

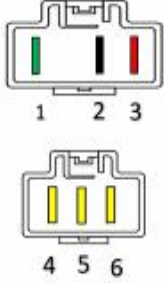

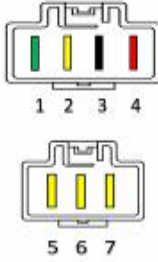

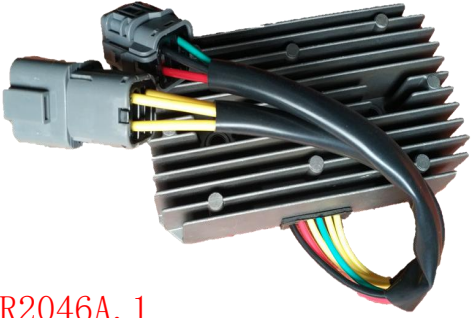
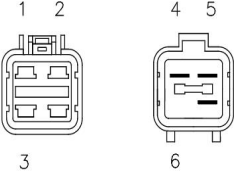
产品资料1		实物主图	接口图	适用范围
产品编号	R2043.5A			汽油机整流器 柴油机整流器 通机整流器 3 线 外壳接地 Ki or Kama K 6500T3 K 6500X K 6700T K 6500T
产品单重	净重152克合盒重180克			
检测程序	168F			
电线插头	6 6 15CM			
内盒尺寸	12*9.5*6CM			
外箱尺寸	49.5*25.5*30.5CM			
输出电压	14.5±0.5V			
一箱只数	50			
铝壳尺寸				
重要说明	绿色电线, 保险管在红线上			
产品编号	R2043.5.1			汽油机整流器 柴油机整流器 通机整流器 3 线 外壳接地 Ki or Kama K 6500T3 K 6500X K 6700T K 6500T
产品单重	净重152克合盒重180克			
检测程序	168F			
电线插头	6 6 15CM			
内盒尺寸	12*9.5*6CM			
外箱尺寸	49.5*25.5*30.5CM			
输出电压	14.5±0.5V			
一箱只数	50			
铝壳尺寸				
重要说明	蓝色电线, 保险管在蓝线上			
产品编号	R2043.5.2			汽油机整流器 柴油机整流器 通机整流器 3 线 外壳接地 186F 187F 等
产品单重	净重152克合盒重180克			
检测程序	168F			
电线插头	20CM			
内盒尺寸	12*9.5*6CM			
外箱尺寸	49.5*25.5*30.5CM			
输出电压	14.5±0.5V			
一箱只数	50			
铝壳尺寸				
重要说明				
产品编号	R2043.6		 <p>1. Ignition Switch/ Sensor 2. Battery (+) / Bateria (+) 3. GND / Masa 4. Power Coil / Bobina de Carga 5. Power Coil / Bobina de Carga 6. Power Coil / Bobina de Carga</p>	Yamaha YFB Timberwolf 250 1994 1996 4GB-81960-00-00 Yamaha YFB 250 1995 1996 4GB-81960-00-00 Yamaha YFM Kodiak 400 1992 1995 4GB-81960-00-00 Yamaha YFM Big Bear 350 1995 1996 4GB-81960-00-00 Yamaha YFM Moto-4 350 1995 4GB-81960-00-00
产品单重	240			
检测程序	315 2339			
电线插头	20CM			
内盒尺寸	12*9.5*6CM			
外箱尺寸	49.5*25.5*30.5CM			
输出电压	14.5±0.5V 25安培			
一箱只数	50			
铝壳尺寸				
重要说明				



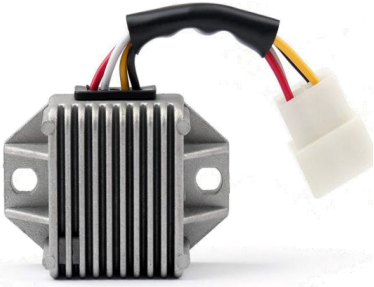

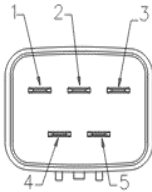

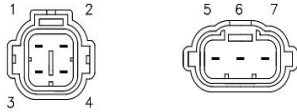
产品资料1		实物主图	接口图	适用范围
产品编号	R2045.1		 <p>4 5 6 7 8</p> <p>1. Battery (+) / Bateria (+) 5. GND / Masa 2. GND / Masa 6. Power Coil / Bobina de Carga 3. Ignition Switch / Sensor 7. Power Coil / Bobina de Carga 4. Battery (+) / Bateria (+) 8. Power Coil / Bobina de Carga</p>	适用于: YHC048 Honda VFR 800 FiY/Fi1/2/3/4/5 2000-2005 31600-MCW-D01 31600-MCW-D61 Honda VFR 800 A2/A3/A4/A5 (ABS Mo 1) 2002-2005 Honda VFR 800 6/7 2006-2007 SH689FA Honda VFR 800 A6/A7/A8/A9 (ABS Mo 1) 2006-2009 Honda RTV1000 2002-2006 Honda CBR1100XX 1999-2000
产品单重	552			
检测程序	M325			
电线插头	黄1.5 25CM			
内盒尺寸	12*9.5*6CM			
外箱尺寸	49.5*25.5*30.5CM			
输出电压	14.5±0.5V MOSFET			
一箱只数	50			
铝壳尺寸				
重要说明	一般用黑色6插			
产品编号	R2045.1A		 <p>4 5 6 7 8</p> <p>1. Battery (+) / Bateria (+) 5. GND / Masa 2. GND / Masa 6. Power Coil / Bobina de Carga 3. Ignition Switch / Sensor 7. Power Coil / Bobina de Carga 4. Battery (+) / Bateria (+) 8. Power Coil / Bobina de Carga</p>	适用于: Honda VFR 800 FiY/Fi1/2/3/4/5 2000-2005 31600-MCW-D01 31600-MCW-D61 Honda VFR 800 A2/A3/A4/A5 (ABS Mo 1) 2002-2005 Honda VFR 800 6/7 2006-2007 Honda VFR 800 A6/A7/A8/A9 (ABS Mo 1) 2006-2009 Honda RTV1000 2002-2006 Honda CBR1100XX 1999-2000 Polaris X res 300 from 1998 to 1999
产品单重	净重 612克			
检测程序	M325			
电线插头	黄1.5 所有线长75CM			
内盒尺寸	12*9.5*6CM			
外箱尺寸	49.5*25.5*30.5CM			
输出电压	14.5±0.5V MOSFET			
一箱只数	50			
铝壳尺寸				
重要说明	一般用黑色6插 长线			
产品编号	R2045.2		 <p>1 2 3 4 5 6 7</p> <p>1. Battery (+) / Bateria (+) 5. Power Coil / Bobina de Carga 2. GND / Masa 6. Power Coil / Bobina de Carga 3. Battery (+) / Bateria (+) 7. Power Coil / Bobina de Carga 4. GND / Masa</p>	适用于: YHC042 iaggio XEvo 400 07-12 iaggio Beverly 400 iaggio GTS300 ie 11-12 iaggio M 3 125 RL 09-12 iaggio Beverly 250 Cruiser 07-08 iaggio Beverly 500 Tourer 08-12 Polaris X res 300 from 1998 to 1999 4060193
产品单重				
检测程序	M325			
电线插头	黄线1.5 X 60 和红绿灯线 25CM			
内盒尺寸	12*9.5*6CM			
外箱尺寸	49.5*25.5*30.5CM			
输出电压	14.5±0.5V MOSFET			
一箱只数	50			
铝壳尺寸				
重要说明				
产品编号	R2045.3		 <p>1 2 3 4 5 6 7</p> <p>1. GND 2. Battery (+) 3. GND 4. Battery (+) 5. Power Coil 6. Power Coil 7. Power Coil</p>	2404 Honda CBR RR 929 2001 2003 31600-MCJ-641 Honda CBR RE 929 2001 2003 31600-MCJ-641 Reem lazo Shin ngen SH678C-13 2414 Honda CBR RR 600 2003 31600-MEE-003 Honda CBR RR 600 2004 2006 31600-MEE-872
产品单重				
检测程序	M325 2404 2414			
电线插头	黄线1.5 X 60 和红绿灯线 25CM			
内盒尺寸	12*9.5*6CM			
外箱尺寸	49.5*25.5*30.5CM			
输出电压	14.5±0.5V MOSFET 35安培			
一箱只数	50			
铝壳尺寸				
重要说明				

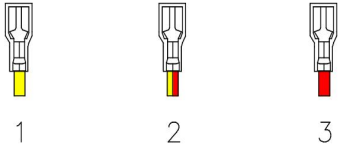

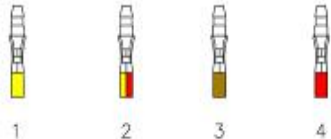

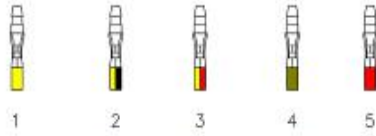

产品资料1		实物主图	接口图	适用范围
产品编号	R2045.4		 <p>1. Battery (+) / Bateria (+) 2. Ignition Switch/ Sensor 3. GND / Masa 4. Battery (+) / Bateria (+) 5. GND / Masa 6. Power Coil / Bobina de Carga 7. Power Coil / Bobina de Carga 8. Power Coil / Bobina de Carga</p>	2472 Kawasaki ZX-12R NINJA 1200 2000 2003 21066-1119 Kawasaki ZX-9R NINJA 900 2000 2003 21066-1119
产品单重	560克			
检测程序	325 2472			
电线插头	黄1.5 X 25CM			
内盒尺寸	12*9.5*6CM			
外箱尺寸	49.5*25.5*30.5CM			
输出电压	14.5±0.5V 35 A			
一箱只数	50			
铝壳尺寸				
重要说明	3黄2红2绿1黑检测			
产品编号	R2045.5		 <p>1. GND / Masa 2. Battery (+) / Bateria (+) 3. GND / Masa 4. Battery (+) / Bateria (+) 5. Power Coil / Bobina de Carga 6. Power Coil / Bobina de Carga 7. Power Coil / Bobina de Carga 8. Ignition Switch / Sensor</p>	YHC065/SKU336483/ SH689HA A lication: Regulator/Rectifier Honda FJS600 All Mo ls 2002-2005 Honda FJS 400 Silverwing 2006-2009 Honda FJS 600 1/2/D3/D4/D5/D6 Silverwing(Non ABS 256mm front disc) 2001-2006 Honda FJS 600 A3-A7/D7 Silverwing(ABS Mo l 276mm front disc) 2003-2009 Honda FSC600 2002-2013
产品单重	510克			
检测程序	M325			
电线插头	黄1.5 X 20 红绿线35CM			
内盒尺寸	12*9.5*6CM			
外箱尺寸	49.5*25.5*30.5CM			
输出电压	14.5±0.5V MOSFET			
一箱只数	50			
铝壳尺寸				
重要说明				
产品编号	R2045.6			21066-0007 sh689cb Kawasaki ZX-12R 1200 B Ninja # ZXT20AB # 2004 Kawasaki ZX-12R 1200 B Ninja # ZXT20AB # 2005 Kawasaki ZX-12R 1200 B Ninja # ZXT20AB # 2006
产品单重	克			
检测程序	M325			
电线插头	黄线1.5 X 60 和红绿灯线 25CM			
内盒尺寸	12*9.5*6CM			
外箱尺寸	49.5*25.5*30.5CM			
输出电压	14.5±0.5V MOSFET			
一箱只数	50			
铝壳尺寸				
重要说明				
产品编号	R2045.7		 <p>1. Battery (+) / Bateria (+) 2. GND / Masa 3. Battery (+) / Bateria (+) 4. GND / Masa 5. Power Coil / Bobina de Carga 6. Power Coil / Bobina de Carga 7. Power Coil / Bobina de Carga</p>	Honda CB Super Four 1300 de 1998 a 2002 31600-MBR-000 Honda CBR F 600 de 1987 a 1988 31600-MN4-008 Honda CBR F 600 de 1987 a 1990 31600-MN4-018 Honda CBR R 400 de 1986 a 1987 31600-KT8-013 Honda NTV Revere 650 de 1988 a
产品单重	450克			
检测程序	M325			
电线插头	黄1.5 X 25CM			
内盒尺寸	12*9.5*6CM			
外箱尺寸	49.5*25.5*30.5CM			
输出电压	14.5±0.5V MOSFET			
一箱只数	50			
铝壳尺寸				
重要说明				



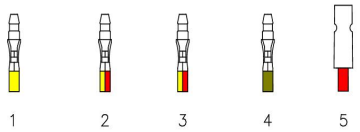

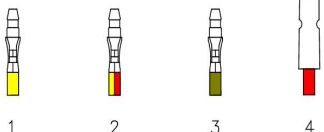

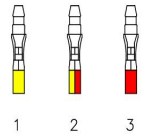
产品资料1		实物主图	接口图	适用范围
产品编号	R2045.8		 <p>1. Ignition Switch / Sensor 4. Power Coil / Bobina de Carga 2. Power Coil / Bobina de Carga 5. Battery (+) / Bateria (+) 3. Power Coil / Bobina de Carga 6. GND / Masa</p>	KAWASAKI ATV Bayou 400 KLF400 4X4 1993-1996 21066-2079 KAWASAKI ATV Bayou 400 KLF400 4X4 1998-1999 KAWASAKI ATV KLF400 Canada Only 1997
产品单重	净重475克 盒重500克			
检测程序	M325			
电线插头	红黄绿1.5 X 20CM			
内盒尺寸	12*9.5*6CM			
外箱尺寸	49.5*25.5*30.5CM			
输出电压	14.5±0.5V MOSFET			
一箱只数	50			
铝壳尺寸				
重要说明				
产品编号	R2045.9		 <p>1. GND 2. Battery (+) 3. Power Coil 4. Power Coil 5. Power Coil</p>	HONDA CB1300 SH689EA 2003-2010
产品单重	450克			
检测程序	M325			
电线插头	红黄绿1.5 X 40CM			
内盒尺寸	12*9.5*6CM			
外箱尺寸	49.5*25.5*30.5CM			
输出电压	14.5±0.5V MOSFET			
一箱只数	50			
铝壳尺寸				
重要说明				
产品编号	R2046.1		 <p>1. Battery (+) / Bateria (+) 2. GND / Masa 3. Power Coil / Bobina de Carga 4. Power Coil / Bobina de Carga 5. Power Coil / Bobina de Carga</p>	Kymco 125 G-Dink 2012 Scooter Voltage Regulator Rectifier 31600-LHG7-E00 2599 M325 Kymco Dink IE Euro 3 200 de 2008 a 2013 31600-KED9-910 Kymco Downtown i 200 de 2010 a 2013 31600-KED9-910 Kymco Downtown i 300 de 2009 a 2013 31600-KED9-910 Kymco Downtown i 125 de 2009 a 2013 31600-L4A-000 SYM JOYMAX 250 SYM MAXI 400 SYM MAXI 600
产品单重	克			
检测程序	M25 2545 2599			
电线插头	25CM			
内盒尺寸	12*9.5*6CM			
外箱尺寸	49.5*25.5*30.5CM			
输出电压	14.5±0.5V			
一箱只数	50			
铝壳尺寸				
重要说明				
产品编号	R2046.2		 <p>1. GND 2. Ignition Switch 3. Battery (+) 4. Power Coil 5. Power Coil 6. Power Coil</p>	31600-L4A-000 SYM JOYMAX 250 SYM MAXI 400 SYM MAXI 600
产品单重	净重404克, 盒重426克			
检测程序	M25			
电线插头	35CM			
内盒尺寸	12*9.5*6CM			
外箱尺寸	49.5*25.5*30.5CM			
输出电压	14.5±0.5V			
一箱只数	50			
铝壳尺寸				
重要说明				



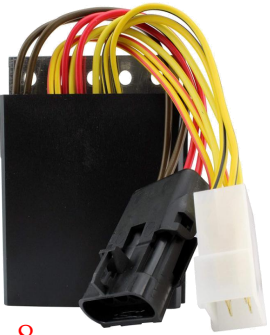
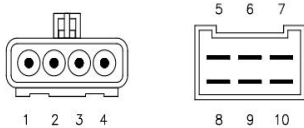

产品资料1		实物主图	接口图	适用范围					
产品编号	R2046.3		 <ol style="list-style-type: none"> 1. GND 2. Power Coil 3. Ignition Switch 4. Battery (+) 5. Power Coil 6. Power Coil 7. Power Coil 	31600-HMA-020 SYM GTS250 300					
产品单重	净重408克, 盒重430克								
检测程序	M25								
电线插头	25CM								
内盒尺寸	12*9.5*6CM								
外箱尺寸	49.5*25.5*30.5CM								
输出电压	14.5±0.5V								
一箱只数	50								
铝壳尺寸									
重要说明									
产品编号	R2046.4			31600-LEA-010 SYM GTS250 300 <table border="1" style="width: 100%; text-align: center;"> <tr><td>31600-LEA-010</td></tr> <tr><td>Confidential</td></tr> <tr><td>Confidential</td></tr> <tr><td>2 Wheels vehicles</td></tr> <tr><td>SYM CITYCOM 300</td></tr> </table>	31600-LEA-010	Confidential	Confidential	2 Wheels vehicles	SYM CITYCOM 300
31600-LEA-010									
Confidential									
Confidential									
2 Wheels vehicles									
SYM CITYCOM 300									
产品单重	净重360克, 盒重380克								
检测程序	M25								
电线插头	4CM做来 要像图片一样长度								
内盒尺寸	12*9.5*6CM								
外箱尺寸	49.5*25.5*30.5CM								
输出电压	14.5±0.5V								
一箱只数	50								
铝壳尺寸									
重要说明									
产品编号	R2046A.1		 <ol style="list-style-type: none"> 1. Ignition Switch / Sensor 2. Battery (+) / Bateria (+) 3. GND / Masa 4. Power Coil / Bobina de Carga 5. Power Coil / Bobina de Carga 6. Power Coil / Bobina de Carga 	2467 Arctic Cat Utility 250 2006 2009 3303-836 Arctic Cat Utility 300 2010 2016 3303-836 Arctic Cat Utility 150 2009 2019 3303-836 Can Am DS 250 2006 2015 S31600RCA000 Kymco MXU 250 2004 2008 31600- LBA7-900					
产品单重	520克								
检测程序	M25								
电线插头	25CM								
内盒尺寸	12*9.5*6CM								
外箱尺寸	49.5*25.5*30.5CM								
输出电压	14.5±0.5V 35安培								
一箱只数	50								
铝壳尺寸									
重要说明									
产品编号	R2047.1		 <ol style="list-style-type: none"> 1. GND 2. Power Coil 3. Power Coil 4. Battery (+) 	KTM: 51111034000 AYA6057 KTM 125 LC2 1996 51111034000 MALAGUTI2600600 YAMAHA: 33G-81960-01-00 33G-81960-60- 00 33G81960-60-00 3BN-81960-01-00 3BN81960-01-00 55V-81960-00-00 55V- 81960-90-00 55V81960-90-00 33G819600100 33G819606000 3BN819600100 55V819600000 55V819609000 55V819609000					
产品单重	克								
检测程序	325								
电线插头	15CM								
内盒尺寸	12*9.5*6CM								
外箱尺寸	49.5*25.5*30.5CM								
输出电压	14.5±0.5V								
一箱只数	50								
铝壳尺寸									
重要说明									

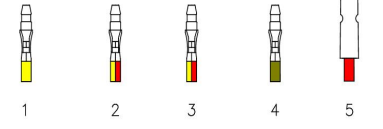

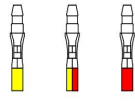

产品资料1		实物主图	接口图	适用范围
产品编号	R2047.2		 <p>1. GND 2. Power Coil 3. Power Coil 4. Battery (+)</p>	Yamaha BW350 1987-1988
产品单重	克			Yamaha DT125E 1989-1991
检测程序	325			Yamaha DT125R 1989-1998
电线插头	15CM			Yamaha DT125RE 1998
内盒尺寸	12*9.5*6CM			Yamaha XT350 1985-2000
外箱尺寸	49.5*25.5*30.5CM			Yamaha XT250L1984
输出电压	14.5±0.5V			
一箱只数	50			
铝壳尺寸				
重要说明				
产品编号	R2048.1		 <p>1. GND / Masa 2. AC Generator / Generador 3. Battery (+) / Bateria (+) 4. AC Generator / Generador 5. AC Generator / Generador</p>	YAMAHA R1 2CR-81960-00-00 FH022BA MTN1000 B67 Bj. 2017-2019 KTM Super Adventure 1290 2017 2018 FH022AA MTN1000D BW8 Bj. 2017 YZF-R1 2CR Bj. 2015 YZF-R1 2CR Bj. 2016 YZF-R1 BX4 Bj. 2017 YZF-R1 BX4 Bj. 2018 YZF-R1 BX4 Bj. 2019 YZF-R1M 2KS Bj. 2015
产品单重	净重160克, 盒重185克			
检测程序	M325			
电线插头	5针插头			
内盒尺寸	100*85*30MM			
外箱尺寸	49.5*25.5*30.5CM			
输出电压	14.5±0.5V			
一箱只数	50			
铝壳尺寸				
重要说明				
产品编号	R2049.1		 <p>1. GND / Masa 2. Lights Relay / Rele de Luces 3. Power Relay / Rele Alimentación 4. Battery (+) / Bateria (+) 5. Power Coil / Bobina de Carga 6. Power Coil / Bobina de Carga 7. Power Coil / Bobina de Carga</p>	KTM EXC 450 de 2012 a 2016 78111034000 KTM EXC 500 de 2012 a 2016 78111034000 KTM EXC-F 250 de 2012 a 2016 78111034000 KTM EXC-F 350 de 2012 a 2016 78111034000 KTM Freeride 350 de 2012 a 2017 78111034000 KTM Rally Factory Replica 450 de
产品单重	230			
检测程序	M325 2568			
电线插头	25 45CM			
内盒尺寸	12*9.5*6CM			
外箱尺寸	49.5*25.5*30.5CM			
输出电压	14.5±0.5V 50安培			
一箱只数	50			
铝壳尺寸				
重要说明	68 MM			
产品编号	R2051.0		 <p>1. Power Coil / Bobina de Carga (Yellow/ Amarillo) 2. Power Coil / Bobina de Carga (Yellow-Red/ Amarillo-Rojo) 3. Battery (+) / Bateria (+) (Red/ Rojo) Aluminium Heatsink/ Disipador de Aluminio: GND/ Masa</p>	YHC116 外壳尺寸: 64*59*20MM 适用于: Polaris - 2x4 / 4x4 / 6x6 250 1993 4060087 Polaris - 4060087 Polaris - L 2x4 / 4x4 350 1993 4060087 Polaris - 2x4 / 4x4 / 6x6 300 from 1994 to 1995 4060087 Polaris Big Boss 1989 4060087 Polaris Big Boss 4x6 from 1989 to 1992 4060087
产品单重	150			
检测程序	215 2097			
电线插头	15CM			
内盒尺寸	100*85*30MM			
外箱尺寸	49.5*25.5*30.5CM			
输出电压	14.5±0.5V 25安培			
一箱只数	50			
外壳尺寸	64*59*20MM			
重要说明				

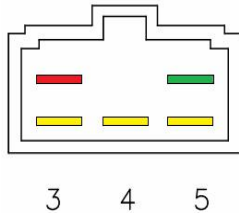

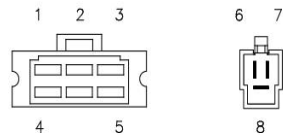
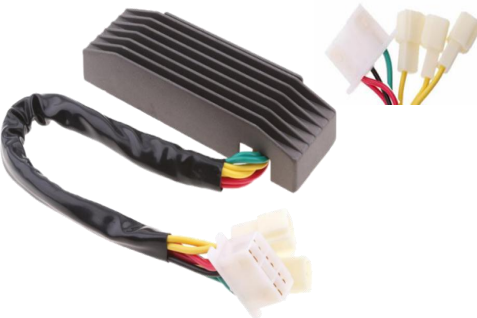
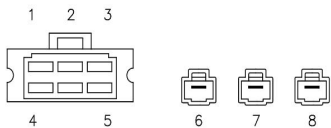

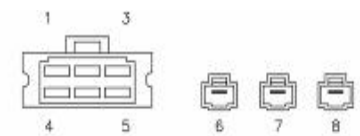
产品资料1		实物主图	接口图	适用范围
产品编号	R2051.1		 <p>1. Power Coil / Bobina de Carga (Yellow/ Amarillo) 2. Power Coil / Bobina de Carga (Yellow-Red/ Amarillo-Rojo) 3. GND / Masa (Brown/ Marron) 4. Battery (+) / Bateria (+) (Red/ Rojo)</p>	YHC118 外壳尺寸: 64*59*20MM Polaris - 2203636 Polaris Big Boss Swedish 6x6 500 1998 4060173 Polaris Big Boss 6x6 500 from 1998 to 1999 4060173 Polaris Big Boss Norwegian 6x6 500 1998 4060173 Polaris Magnum VL HDS 500 2002 4060173 Polaris Magnum 500 from 1999 to 2002
产品单重	150			
检测程序	215 2098			
电线插头	15CM			
内盒尺寸	100*85*30MM			
外箱尺寸	49.5*25.5*30.5CM			
输出电压	14.5±0.5V 25安培			
一箱只数	50			
外壳尺寸	64*59*20MM			
重要说明				
产品编号	R2051.2		 <p>1. Power Coil / Bobina de Carga (Yellow/ Amarillo) 2. Power Coil / Bobina de Carga (Yellow-Black/ Amarillo-Negro) 3. Power Coil / Bobina de Carga (Yellow-Red/ Amarillo-Rojo) 4. GND / Masa (Brown/ Marron) 5. Battery (+) / Bateria (+) (Red/ Rojo)</p>	Polaris - Norwegian 6x6 400 1996 4060133 Polaris - 6x6 400 1996 4060133 Polaris - 4060133 Polaris - LR-37 Polaris Big Boss L 6x6 400 1997 4060133 Polaris Magnum Norwegian 4x4 1997 4060133 Polaris Magnum 4x4 1996 1997 4060133
产品单重	170			
检测程序	315 2099			
电线插头	15CM			
内盒尺寸	100*85*30MM			
外箱尺寸	49.5*25.5*30.5CM			
输出电压	14.5±0.5V 35安培			
一箱只数	50			
外壳尺寸	77*74*20MM			
重要说明				
产品编号	R2051.3			Click image to open and view Voltage Regulator Rectifier Polaris Snowmobiles 4060122 4060123 4060092 4060071 2203873
产品单重	113			
检测程序	QFAC-1			
电线插头	15CM			
内盒尺寸	100*85*30MM			
外箱尺寸	49.5*25.5*30.5CM			
输出电压	14.5±0.5V			
一箱只数	50			
外壳尺寸	64*59*20MM			
重要说明				
产品编号	R2051C.3			Polaris Indy Ultra 680, 1996-1998, 4060122 4060071 4060092 2203873 4030123 4060122 4060071 4060092 2203873 4030123 Polaris Snowmobiles 400 1991 - 398cc Polaris Snowmobiles 440 1992 - 432cc Polaris Snowmobiles 440 Indy 1998 - 432cc
产品单重	113			
检测程序	QFAC-1			
电线插头	15CM			
内盒尺寸	100*85*30MM			
外箱尺寸	49.5*25.5*30.5CM			
输出电压	14.5±0.5V			
一箱只数	50			
外壳尺寸	64*59*20MM			
重要说明				

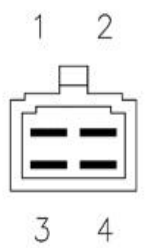
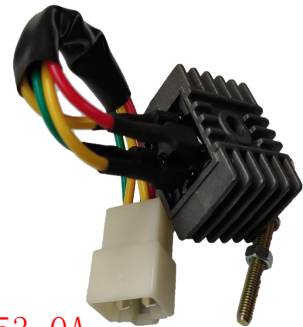
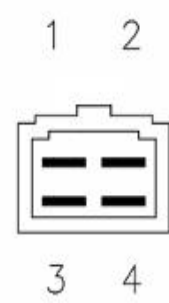

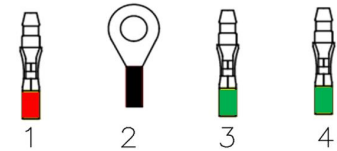

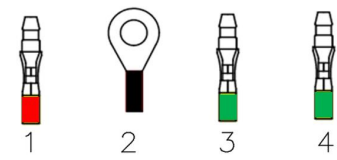

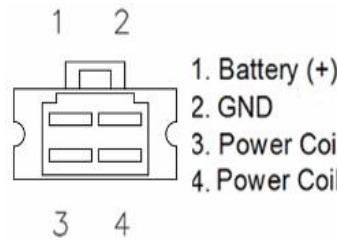
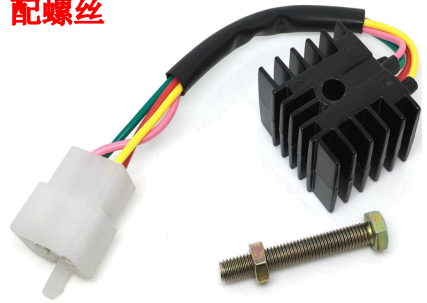
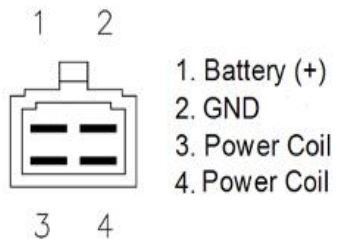
产品资料1		实物主图	接口图	适用范围
产品编号	R2051.4		 <ol style="list-style-type: none"> 1. Power Coil / Bobina de Carga (Yellow/ Amarillo) 2. Power Coil / Bobina de Carga (Yellow-Red/ Amarillo-Rojo) 3. Power Coil / Bobina de Carga (Yellow-Red/ Amarillo-Rojo) 4. GND / Masa (Brown/ Marron) 5. Battery (+) / Batería (+) (Red/ Rojo) 	Polaris Ranger 2x4 500 2004 4010929 Polaris Ranger 4x4 500 2004 2204317 Polaris Ranger 6x6 500 2004 2204317 Polaris Sportsman 600 2004 4010929 Polaris Sportsman 700 2004 2204317
产品单重	170			
检测程序	315 2451			
电线插头	15CM			
内盒尺寸	100*85*30MM			
外箱尺寸	49.5*25.5*30.5CM			
输出电压	14.5±0.5V			
一箱只数	50			
外壳尺寸	77*74*20MM			
重要说明				
产品编号	R2051.5		 <ol style="list-style-type: none"> 1. Power Coil / Bobina de Carga (Yellow/ Amarillo) 2. Power Coil / Bobina de Carga (Yellow-Red/ Amarillo-Rojo) 3. GND / Masa (Brown/ Marron) 4. Battery (+) / Batería (+) (Red/ Rojo) 	Polaris - 2203638 Polaris AT 4x4 500 2004 4010670 Polaris Magnum 4x4 500 2003 4010670 Polaris TV Series 10 6x6 500 2002 4010670 Polaris Ranger Series 11 500 from 2003 to 2004 4010670 Polaris Scrambler 4x4 500 2003 4010670 Polaris Sportsman 600 from 2003 to 2004 4010796
产品单重	150			
检测程序	215 2451			
电线插头	15CM			
内盒尺寸	100*85*30MM			
外箱尺寸	49.5*25.5*30.5CM			
输出电压	14.5±0.5V 25安培			
一箱只数	50			
外壳尺寸	64*59*20MM			
重要说明				
产品编号	R2051.6		 <ol style="list-style-type: none"> 1. Power Coil / Bobina de Carga (Yellow/ Amarillo) 2. Power Coil / Bobina de Carga (Yellow-Red/ Amarillo-Rojo) 3. Battery (+) / Batería (+) (Red/ Rojo) Aluminium Heatsink/ Disipador de Aluminio: GND / Masa	Polaris - 4060208 Polaris Scrambler 4x4 400 from 2000 to 2002 4060208 Polaris Scrambler 2x4 400 from 2000 to 2002 4060208 Polaris Sport 400 1999 4060208 Polaris Trail Blazer 400 2003 4060208 Polaris Trail Blazer 250 from 1999 to 2003 4060208 Polaris Xplorer 4x4 250 from 2000
产品单重	150			
检测程序	215 2471			
电线插头	15CM			
内盒尺寸	100*85*30MM			
外箱尺寸	49.5*25.5*30.5CM			
输出电压	14.5±0.5V 25安培			
一箱只数	50			
铝壳尺寸				
重要说明				
产品编号	R2051.7			Polaris 400 L -- 1994-1995 Polaris Big Boss 400 L -- 1994-1997 Polaris Magnum 425 2x4 -- 1995-1997 Polaris Magnum 425 4x4 -- 1995-1997 Polaris Magnum 425 6x6 -- 1996-1997 Polaris Sportsman 400 -- 1994-1997 Polaris Sportsman 500 4x4 -- 1996-1997 Polaris Xplorer 400 -- 1995-1997 Polaris Xplorer 400 L -- 1996-1997 Polaris Xplorer 500 -- 1997
产品单重	170			
检测程序				
电线插头	15CM			
内盒尺寸	100*85*30MM			
外箱尺寸	49.5*25.5*30.5CM			
输出电压	14.5±0.5V			
一箱只数	50			
外壳尺寸	77*74*20MM			
重要说明				

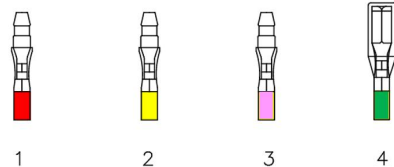



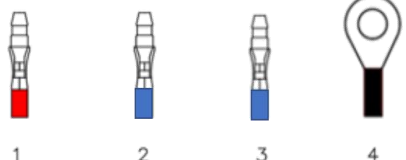

产品资料1		实物主图	接口图	适用范围
产品编号	R2051.8		 <p>1. GND / Masa 2. GND / Masa 3. Battery (+) / Batería (+) 4. Battery (+) / Batería (+) 5. Power Coil / Bobina de Carga</p> <p>6. Power Coil / Bobina de Carga 7. Power Coil / Bobina de Carga 8. Power Coil / Bobina de Carga 9. Power Coil / Bobina de Carga 10. Power Coil / Bobina de Carga</p>	Polaris S ortsman 700 4x4 2004 OEM:4011024 2205239
产品单重				
检测程序	M325 2533			
电线插头	1.5 X 20CM			
内盒尺寸	20X 16X 10CM			
外箱尺寸	49.5*36.5*62CM			
输出电压	14.5±0.5V 35安培			
一箱只数				
铝壳尺寸				
重要说明				
产品编号	R2051A.1		 <p>1. Power Coil 交流输入 2. Power Coil 交流输入 3. Ignition 电压检测 4. GND(-) 负极输出 5. Battery(+) 正极输出</p>	适用于: 1996-1997 Polaris MAGNUM 2X4 1996-1997 Polaris MAGNUM 4X4 1996-1997 Polaris MAGNUM 6X6 1996 Polaris S ORTSMA 1996-1997 Polaris S ORTSMAN 500 1996-1997 Polaris Big Boss 400 L 6x6 1996-1997 Polaris Magnum 425 1996-1997 Polaris Magnum 425 4x4 1996-1997 Polaris Magnum 425 6x6
产品单重	170			
检测程序	215			
电线插头	15CM			
内盒尺寸	100*85*30MM			
外箱尺寸	49.5*25.5*30.5CM			
输出电压	14.5±0.5V			
一箱只数	50			
外壳尺寸	77*74*20MM			
重要说明				
产品编号	R2051A.2		 <p>1. Power Coil / Bobina de Carga (Yellow/ Amarillo) 2. Power Coil / Bobina de Carga (Yellow-Red/ Amarillo-Rojo) 3. Power Coil / Bobina de Carga (Yellow-Red/ Amarillo-Rojo) 4. GND / Masa (Brown/ Marron) 5. Battery (+) / Batería (+) (Red/ Rojo)</p>	2357 Polaris Ranger 2x4 500 2004 4010929 Polaris Ranger 4x4 500 2004 2204317 Polaris Ranger 6x6 500 2004 2204317 Polaris S ortsman 600 2004 4010929 Polaris S ortsman 700 2004 2204317
产品单重	175			
检测程序	315 2357			
电线插头	15CM			
内盒尺寸	100*85*30MM			
外箱尺寸	49.5*25.5*30.5CM			
输出电压	14.5±0.5V			
一箱只数	50			
外壳尺寸	77*74*20MM			
重要说明				
产品编号	R2051A.3		 <p>1. Power Coil / Bobina de Carga (Yellow/ Amarillo) 2. Power Coil / Bobina de Carga (Yellow-Black/ Amarillo-Negro) 3. Power Coil / Bobina de Carga (Yellow-Red/ Amarillo-Rojo) 4. GND / Masa (Brown/ Marron) 5. Battery (+) / Batería (+) (Red/ Rojo)</p>	4060191 Polaris X edition 425 Voltage Regulator Rectifier 13103 Polaris - 4060133 Polaris Big Boss L 6x6 400 1997 4060133 Polaris Magnum 2x4 from 1996 to 1997 4060133 Polaris Magnum Norwegian 4x4 1997 4060133 Polaris Magnum 4x4 from 1996 to 1997 4060133
产品单重				
检测程序	315 2300 2099			
电线插头	15CM			
内盒尺寸	100*85*30MM			
外箱尺寸	49.5*25.5*30.5CM			
输出电压	14.5±0.5V 35安培			
一箱只数	50			
外壳尺寸	77*74*20MM			
重要说明				



产品资料1		实物主图	接口图	适用范围
产品编号	R2051A.4		 <p>1. Power Coil / Bobina de Carga (Yellow/ Amarillo) 2. Power Coil / Bobina de Carga (Yellow-Red/ Amarillo-Rojo) 3. Battery (+) / Batería (+) (Red/ Rojo) Aluminium Heatsink/ Disipador de Aluminio: GND / Masa</p>	Polaris - 4060208 Polaris Scrambler 4x4 400 from 2000 to 2002 4060208 Polaris Scrambler 2x4 400 from 2000 to 2002 4060208 Polaris Sport 400 1999 4060208 Polaris Trail Blazer 400 2003 4060208 Polaris Trail Blazer 250 from 1999 to 2003 4060208 Polaris Xplorer 4x4 250 from 2000
产品单重				
检测程序	215			
电线插头	15CM			
内盒尺寸	100*85*30MM			
外箱尺寸	49.5*25.5*30.5CM			
输出电压	14.5±0.5V			
一箱只数	50	R2051A.4	R2051A.4	
重要说明			 <p>1. Battery (+) 2. GND 3. Power Coil 4. Power Coil 5. Power Coil</p>	2436 Reemlazo Shin ngen SH576A-12 Suzuki DR 650 1992 1995 32800-12E00 Suzuki VS GL Intruder 600 1996 1997 32800-12E01 Suzuki VS GL Intruder 800 1992 2004 32800-12E01 Suzuki VS S50 Boulevard 800 2005 2009 32800-12E01 Suzuki VS GL Intruder 1400 1996 2004 32800-12E01
产品编号	R2052.0			
产品单重	260			
检测程序	325 2436			
电线插头	35CM			
内盒尺寸	12*9.5*6CM			
外箱尺寸	49.5*25.5*30.5CM			
输出电压	14.5±0.5V 35安培			
一箱只数	50	R2052.0	R2052.0	
铝壳尺寸			 <p>1. Battery (+) / Batería (+) 2. Ignition Switch / Sensor 3. GND / Masa 4. Battery (+) / Batería (+) 5. GND / Masa 6. Power Coil / Bobina de Carga 7. Power Coil / Bobina de Carga 8. Power Coil / Bobina de Carga</p>	2445 SReemlazo Shin ngen SH576-12 [38B] Suzuki VS Intruder 1400 1987 1995 32800-38B00
重要说明				
产品编号	R2052.1			
产品单重	270			
检测程序	325 2445			
电线插头	35CM			
内盒尺寸	12*9.5*6CM			
外箱尺寸	49.5*25.5*30.5CM			
输出电压	14.5±0.5V 35安培			
一箱只数	50	R2052.1	R2052.1	
铝壳尺寸			 <p>1. Battery (+) / Batería (+) 2. Ignition Switch / Sensor 3. GND / Masa 4. Battery (+) / Batería (+) 5. GND / Masa 6. Power Coil / Bobina de Carga 7. Power Coil / Bobina de Carga 8. Power Coil / Bobina de Carga</p>	2334 35A Reemlazo Shin ngen SH576-12 [38A] Suzuki VS Intruder 700 1985 1987 32800-38A00 Suzuki VS Intruder 750 1988 1991 32800-38A00 Suzuki VS Intruder 800 1992 1997 32800-38A00
重要说明				
产品编号	R2052.2			
产品单重	270			
检测程序	325 2334			
电线插头	35CM			
内盒尺寸	12*9.5*6CM			
外箱尺寸	49.5*25.5*30.5CM			
输出电压	14.5±0.5V 35安培			
一箱只数	50	R2052.2	R2052.2	
铝壳尺寸				
重要说明				

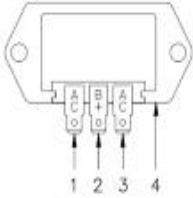

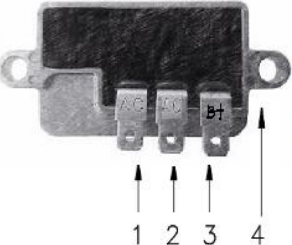

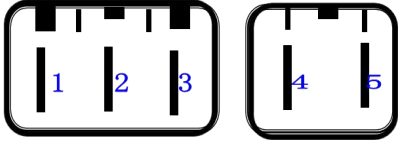

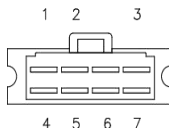
产品资料1		实物主图	接口图	适用范围
产品编号	R2052. 2. 1		 <p>1. Battery (+) / Bateria (+) 2. GND / Masa 3. GND / Masa 4. Battery (+) / Bateria (+) 5. GND / Masa 6. Power Coil / Bobina de Carga 7. Power Coil / Bobina de Carga 8. Power Coil / Bobina de Carga</p>	YHC132 OEM:32800-38A00 Suzuki VS 800cc Intru r (1992-1997) Suzuki VS 700cc Intru r (1985-1987) Suzuki VS 750cc Intru r (1988-19991)
产品单重	270			
检测程序	325			
电线插头	35CM			
内盒尺寸	12*9. 5*6CM			
外箱尺寸	49. 5*25. 5*30. 5CM			
输出电压	14. 5±0. 5V			
一箱只数	50			
铝壳尺寸				
重要说明				
产品编号	R2053. 0		 <p>1. Battery (+) 2. GND 3. Power Coil 4. Power Coil</p>	31700-107-782 Honda CB100 CB125S CL100 CL100S SL100 SL125 Rectifier Assy NOS 31700-107-782 CT90
产品单重	90克			
检测程序	整流器桥			
电线插头	15CM1平方线			
内盒尺寸	100*85*30MM			
外箱尺寸	49. 5*25. 5*30. 5CM			
输出电压	14. 5±0. 5V			
一箱只数	50			
铝壳尺寸				
重要说明	1黄1粉红 1 红1绿			
产品编号	R2053. 0A		 <p>1. Battery (+) 2. GND 3. Power Coil 4. Power Coil</p>	31700-107-782 Honda CB100 CB125S CL100 CL100S SL100 SL125 Rectifier Assy NOS 31700-107-782 CT90
产品单重	90克			
检测程序	整流器桥			
电线插头	15CM1平方线			
内盒尺寸	100*85*30MM			
外箱尺寸	49. 5*25. 5*30. 5CM			
输出电压	14. 5±0. 5V			
一箱只数	50			
铝壳尺寸				
重要说明	1黄1粉红 1 红1绿			
产品编号	R2053. 1		 <p>1. Battery [+] red 2. GND [-] black 3. Power Coil AC yellow 4. Power Coil AC yellow</p>	Outboard Rectifier Regulator 4H - 70H 2 Stroke Yamaha Mariner Suzuki Tohatsu6F5-81970 6F5-81960-60/61/62, 6F5-81960-00-00
产品单重	90克			
检测程序	整流器桥			
电线插头	15CM小线			
内盒尺寸	100*85*30MM			
外箱尺寸	49. 5*25. 5*30. 5CM			
输出电压	14. 5±0. 5V			
一箱只数	50			
铝壳尺寸				
重要说明				

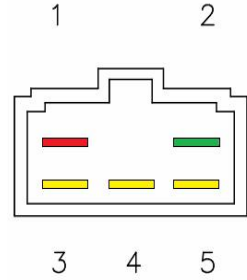
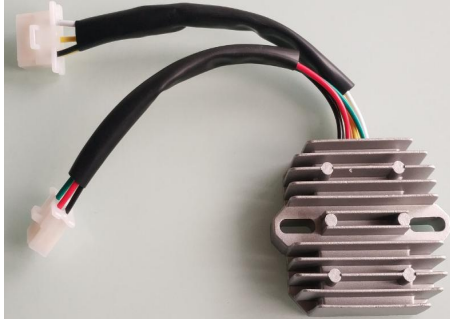
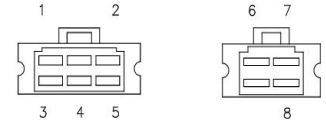
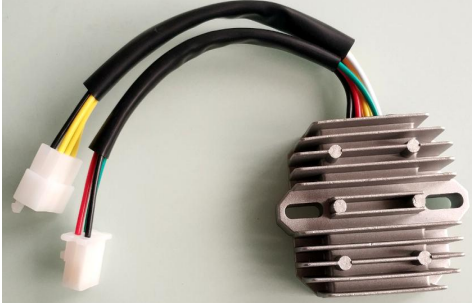
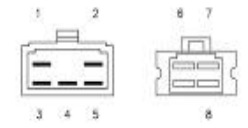

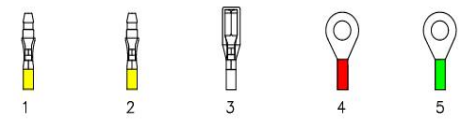

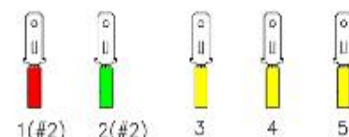

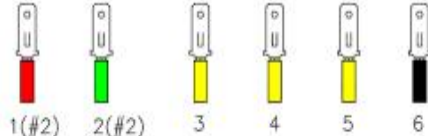
产品资料1		实物主图	接口图	适用范围
产品编号	R2053.1DC		 <p>1. Battery [+] 2. GND [-] 3. Power Coil AC 4. Power Coil AC</p>	Outboard Rectifier Regulator 4H - 70H 2 Stroke Yamaha Mariner Suzuki Tohatsu 6F5-81970 6F5-81960-60/61/62, 6F5-81960-00-00
产品单重	90克			
检测程序	整流器桥			
电线插头	15CM小线			
内盒尺寸	100*85*30MM			
外箱尺寸	49.5*25.5*30.5CM			
输出电压	14.5±0.5V			
一箱只数	50			
铝壳尺寸				
重要说明	R2053.1+对插配件			
产品编号	R2053.2		 <p>1. Battery (+) 2. GND 3. Power Coil 4. Power Coil</p>	Honda Regulator Rectifier CL 350 360 450 CJ 360 SL 350 Twins Motorcycle NEW 2FM-46-20250 replaces 31700-455-671 / 31700-358-30
产品单重	90克			
检测程序	整流器桥			
电线插头	15CM小线 红黄绿橙			
内盒尺寸	100*85*30MM			
外箱尺寸	49.5*25.5*30.5CM			
输出电压	14.5±0.5V			
一箱只数	50			
铝壳尺寸				
重要说明	1黄1粉红 1 红1绿			
产品编号	R2053.3		 <p>1. Battery (+) 2. GND 3. Power Coil 4. Power Coil</p>	Honda Replacement Voltage Regulator CB CL SL 100 125 31700-455-671, 31700-358-305, 31700-358-013 是6V 的 1968-1973 Honda CB350 1973 Honda CB350G 1974 Honda CB360 1974 Honda CB360G 1975-1976 Honda CB360T 1968-1974 Honda CB450 1975-1976 Honda CB500T 1976-1977 Honda CJ360T
产品单重	盒重95克			
检测程序	整流器桥			
电线插头	15CM小线 红黄绿橙			
内盒尺寸	100*85*30MM			
外箱尺寸	49.5*25.5*30.5CM			
输出电压	14.5±0.5V			
一箱只数	50			
铝壳尺寸				
重要说明	1黄1粉红 1 红1绿			
产品编号	R2053.4		 <p>1. Battery (+) / Bateria (+) (Red/ Rojo) 2. Power Coil / Bobina de Carga (Yellow/ Amarillo) 3. Power Coil / Bobina de Carga 4. GND/ Masa</p>	Honda Trail CT 90 1968 1975 31700-102-701 6 Volts K1 K2 K3 K4
产品单重	90克			
检测程序	整流器桥			
电线插头	15CM小线 红黄绿橙			
内盒尺寸	100*85*30MM			
外箱尺寸	49.5*25.5*30.5CM			
输出电压	14.5±0.5V			
一箱只数	50			
铝壳尺寸				
重要说明	1黄1粉红 1 红1绿			

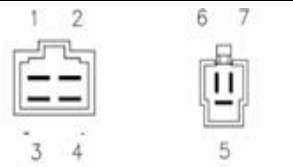

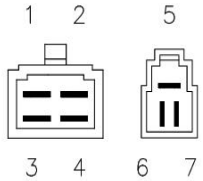

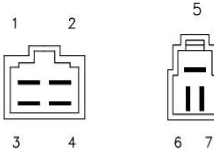

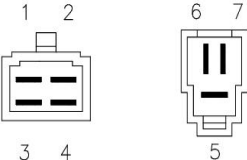
产品资料1		实物主图	接口图	适用范围
产品编号	R2053.5			Honda Assy Fits GX610 GX620 GXV530 OEM 31710-ZJ1-812
产品单重	净重63克 盒重78克			
检测程序	整流器桥			
电线插头	15CM小线 1白2灰			
内盒尺寸	100*85*30MM			
外箱尺寸	49.5*25.5*30.5CM			
输出电压	14.5±0.5V			
一箱只数	50			
铝壳尺寸				
重要说明	2灰白1白 外壳负极			
产品编号	R2053A.1		 <ol style="list-style-type: none"> 1. Battery (+) / Bateria (+) (Red/ Rojo) 2. Power Coil / Bobina de Carga (Yellow/ Amarillo) 3. Power Coil / Bobina de Carga 4. GND/ Masa 	32800-95D10 Rectifier & Regulator Asy Suzuki Outboard 25H 30H 75H 85H 2T 664-81970-61 Rectifier Assy Yamaha arsun owertec Outboard 6H - 40H 2/4T 664-81970-61 664-81970-62, 664-81970- 60 雅马哈船外机30 马力船外机配件整 流器664-81970-61 F15-07060001
产品单重	净重54克			
检测程序	整流器桥			
电线插头	15CM小线			
内盒尺寸	100*85*30MM			
外箱尺寸	49.5*25.5*30.5CM			
输出电压	14.5±0.5V			
一箱只数	50			
铝壳尺寸				
重要说明				
产品编号	R2053A.2			Yamaha 25-70 H Outboard 6G1- 81970-61 1984-2001 (1081)
产品单重				
检测程序	整流器桥			
电线插头	15CM小线 红线25+15+20			
内盒尺寸	100*85*30MM			
外箱尺寸	49.5*25.5*30.5CM			
输出电压	14.5±0.5V			
一箱只数	50			
铝壳尺寸				
重要说明				
产品编号	R2053A.3			Suzuki DT6/85 01-02 DF9-15 01- Tohatsu 32800-95D01 158-9501 32800- 95D01 3B2760600, 3B2760600M, 3G2760600M, 32800-95D00, 32800-95D01, 32800-95720, 346760600, 346760600M, 346760601, 346760601M, 361760600, 361760600M
产品单重				
检测程序	整流器桥			
电线插头	15 30CM小线			
内盒尺寸	100*85*30MM			
外箱尺寸	49.5*25.5*30.5CM			
输出电压	14.5±0.5V			
一箱只数	50			
铝壳尺寸				
重要说明				

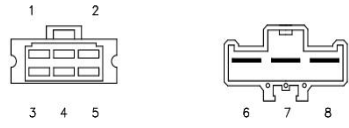

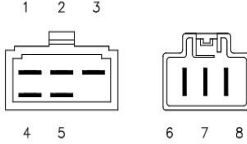

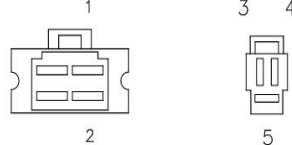

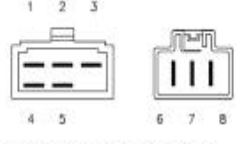
产品资料1		实物主图	接口图	适用范围
产品编号	R2053A.4			3G2-76060-0
产品单重				
检测程序	整流器桥			
电线插头	10 20 CM小线			
内盒尺寸	100*85*30MM			
外箱尺寸	49.5*25.5*30.5CM			
输出电压	14.5±0.5V			
一箱只数	50			
铝壳尺寸				
重要说明				
产品编号	R2054.0		 <p>1. Power Coil / Bobina de Carga 2. Battery (+) / Bateria (+) 3. Power Coil / Bobina de Carga 4. GND / Masa</p>	John Deere MIA11665 John Deere AM106357 John Deere AM34738 John Deere AM102596 Kohler 41-403-09-S Kohler 41-403-04 Kohler 25-755-03-S Kohler 234279 Kohler 41-403-09 Kohler 41-403-05 Kohler 41-403-01
产品单重	87克			
检测程序	2054 专用 2637			
电线插头				
内盒尺寸	70*70*33MM			
外箱尺寸	49.5*25.5*30.5CM			
输出电压	14.5±0.5V 15安培			
一箱只数	50			
铝壳尺寸				
重要说明				
产品编号	R2054A.1		 <p>1. Power Coil 2. Power Coil 3. Battery (+) 4. GND</p>	21066-7017 煌竹定做的 trr2277 JOHN DEERE 318-420 191-1748
产品单重	87克			
检测程序	2054 专用			
电线插头				
内盒尺寸	100*85*30MM			
外箱尺寸	49.5*25.5*30.5CM			
输出电压	14.5±0.5V 15安培			
一箱只数	50			
铝壳尺寸				
重要说明				
产品编号	R2055.0		 <p>1. Power Coil / Bobina de Carga 2. Power Coil / Bobina de Carga 3. Power Coil / Bobina de Carga 4. Battery (+) 5. GND / Masa</p>	Honda CB1000R CB600F 整流器 SH750AA sh784aa sh300 31600-MFG-D01 31600-mfm-701
产品单重	300克			
检测程序	M325			
电线插头	3针+2针			
内盒尺寸	12*9.5*6CM			
外箱尺寸	49.5*25.5*30.5CM			
输出电压	14.5±0.5V			
一箱只数	50			
铝壳尺寸				
重要说明				

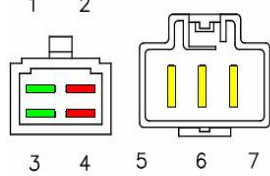

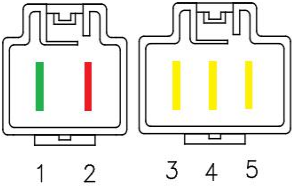

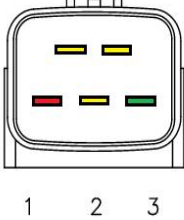

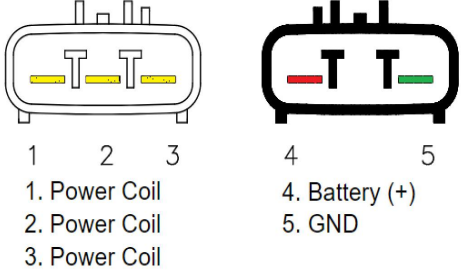
产品资料1		实物主图	接口图	适用范围
产品编号	R2056.0		 <ol style="list-style-type: none"> 1. Battery (+) / Bateria (+) 2. Power Coil / Bobina de Carga 3. GND / Masa 4. Battery (+) / Bateria (+) 5. Power Coil / Bobina de Carga 6. Power Coil / Bobina de Carga 7. GND / Masa 	2307 25A Honda CB HondaMatic 750 1977 1978 31700-371-000 Honda GL Goldwing 1100 1980 1983 31600-MG9-010 Honda GL Goldwing 1100 1980 1983 31600-463-008 Honda GL Goldwing DG 1200 1984 1987 31600-MG9-000 Honda GL Goldwing DG 1200 1984 1987 31600-MG9-010
产品单重	克			
检测程序	325 2307			
电线插头	20CM			
内盒尺寸	12*9.5*6CM			
外箱尺寸	49.5*25.5*30.5CM			
输出电压	14.5±0.5V 25安培			
一箱只数	50			
铝壳尺寸				
重要说明				
产品编号	R2056.1		 <ol style="list-style-type: none"> 1. Battery (+) 2. GND 3. Power Coil 4. Power Coil 5. Power Coil 	2312 35A Reem lazo Kokusan nki RS41-29 Suzuki - 32800-33E21 Suzuki GSX R 600 2001 2005 32800-33E20 Suzuki GSX R 750 1998 2005 32800-33E20 Suzuki GSX R 1000 2001 2004 32800-33E20 Suzuki GSX R 600 1997 2000 32800-33E00
产品单重	克			
检测程序	325 2312 2510 2312			
电线插头	20CM			
内盒尺寸	12*9.5*6CM			
外箱尺寸	49.5*25.5*30.5CM			
输出电压	14.5±0.5V 35安培			
一箱只数	50			
铝壳尺寸				
重要说明	3黑1红1绿			
产品编号	R2056.2		 <ol style="list-style-type: none"> 1. Field Coil / Bobina de Campo 2. Ignition Switch / Sensor 3. Power Coil / Bobina de Carga 4. Power Coil / Bobina de Carga 5. Power Coil / Bobina de Carga 6. GND / Masa 7. Battery (+) / Bateria (+) 8. Ignition Switch / Sensor 	2335 25A CAM 0 - Honda CB 650 1981 1982 31600-460-731 Honda CB 650 1979 1980 31600-426-000 Honda CBX F/F2 750 1984 1986 31600-MJ0-612 Honda CBX /F 400 1985 31600-MJ0-612
产品单重	290克			
检测程序	CB750+励磁 2335			
电线插头	20CM			
内盒尺寸	12*9.5*6CM			
外箱尺寸	49.5*25.5*30.5CM			
输出电压	14.5±0.5V 25安培			
一箱只数	50			
铝壳尺寸				
重要说明	3黄1红正1绿负1白励磁 2 黑检测			
产品编号	R2056.3		 <ol style="list-style-type: none"> 1. Field Coil / Bobina de Campo 2. Ignition Switch / Sensor 3. Power Coil / Bobina de Carga 4. Power Coil / Bobina de Carga 5. Power Coil / Bobina de Carga 6. GND / Masa 7. Battery (+) / Bateria (+) 8. Ignition Switch / Sensor 	2329 35A Honda CB F / C / K / SC 750 1981 1983 31600-MA6-000 Honda CB F / C 900 1981 1982 31600-MA6-000 Honda CB C / F / K / SC 750 1981 1983 31600-461-771 Honda CB C / F 900 1981 1982 31600-461-771 Honda CB C 900 1980 31600-MA6-910 Honda CB C 1000 1983 31600-MA7-008
产品单重	321.5克			
检测程序	CB750+励磁 2514 2538 2329			
电线插头	20CM			
内盒尺寸	12*9.5*6CM			
外箱尺寸	49.5*25.5*30.5CM			
输出电压	14.5±0.5V 25安培			
一箱只数	50			
铝壳尺寸				
重要说明	3黄1红正1绿负1白励磁 2 黑检测			

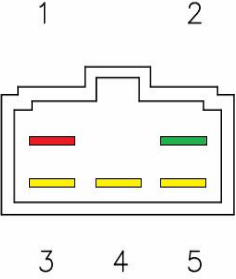

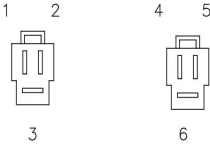

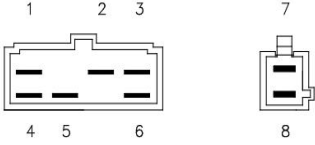

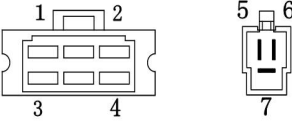
产品资料1		实物主图	接口图	适用范围
产品编号	R2056.4		 <p>1. Power Coil / Bobina de Carga (Yellow/ Amarillo) 2. Power Coil / Bobina de Carga (Yellow/ Amarillo) 3. Charge Lamp/ Lámpara Piloto 4. Battery (+) / Batería (+) (Red/ Rojo) 5. GND/ Masa (Green/Verde)</p>	2309 35A Ducati - Ducati 748 1997 Ducati 750 aso 1987 2001 Ducati 750 S ort 1987 2001 Ducati 750 F1 1987 2001 Ducati 750 SS 1987 2001 Ducati 851 1990 1993 Ducati 888 1990 1993 Ducati 900 ST2 1988 1998 Ducati 900 SSR 1989 1993
产品单重	克			
检测程序	QF2101 新款 2309 同 R2101.8			
电线插头	20 红绿线50CM			
内盒尺寸	12*9.5*6CM			
外箱尺寸	49.5*25.5*30.5CM			
输出电压	14.5±0.5V 35安培			
一箱只数	50			
铝壳尺寸				
重要说明				
产品编号	R2056.5		 <p>1. Battery (+) / Batería (+) (Red/Rojo) 2. GND / Masa (Green/ Verde) 3. Power Coil / Bobina de Carga (Yellow/Amarillo) 4. Power Coil / Bobina de Carga (Yellow/Amarillo) 5. Power Coil / Bobina de Carga (Yellow/Amarillo)</p>	Universal 5 cables 12V 35A s/s
产品单重	克			
检测程序	M325 10185			
电线插头	35CM			
内盒尺寸	12*9.5*6CM			
外箱尺寸	49.5*25.5*30.5CM			
输出电压	14.5±0.5V 35安培			
一箱只数	50			
铝壳尺寸				
重要说明				
产品编号	R2056.6		 <p>1. Battery (+) / Batería (+) (Red/Rojo) 2. GND / Masa (Green/ Verde) 3. Power Coil / Bobina de Carga (Yellow/Amarillo) 4. Power Coil / Bobina de Carga (Yellow/Amarillo) 5. Power Coil / Bobina de Carga (Yellow/Amarillo) 6. Ignition Switch/ Sensor (Black/Negro)</p>	Universal 8 cables 12V 35A con sensor
产品单重	克			
检测程序	M325 10186			
电线插头	35CM			
内盒尺寸	12*9.5*6CM			
外箱尺寸	49.5*25.5*30.5CM			
输出电压	14.5±0.5V 35安培			
一箱只数	50			
铝壳尺寸				
重要说明				
产品编号	R2056.7		 <p>1. Battery (+) / Batería (+) 2. GND / Masa 3. Battery (+) / Batería (+) 4. GND / Masa 5. Power Coil / Bobina de Carga 6. Power Coil / Bobina de Carga 7. Power Coil / Bobina de Carga</p>	Suzuki - 32800-06G02 Suzuki DL V-Strom 1000 2010 2012 32800-06G01 Suzuki DL V-Strom 1000 2002 2009 32800-06G00 RM30104-R00 Trium h T1300823 Trium h T1301234 Trium h Daytona 675 RM30104 2006 TRIUM H 675cc Daytona 675 RM30104 2007 TRIUM H 675cc Daytona 675 RM30104 2008 TRIUM H
产品单重	克			
检测程序	M325			
电线插头	20CM			
内盒尺寸	12*9.5*6CM			
外箱尺寸	49.5*25.5*30.5CM			
输出电压	14.5±0.5V			
一箱只数	50			
铝壳尺寸				
重要说明	3黄2红2黑			

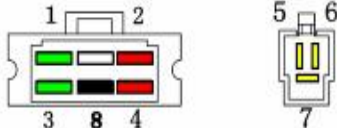

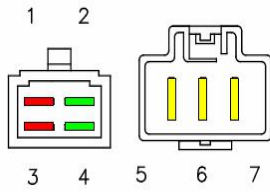

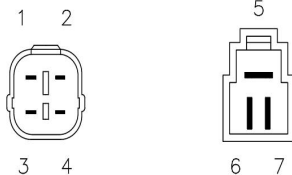

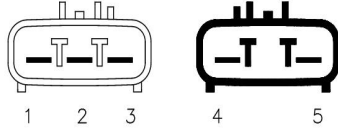
产品资料1		实物主图	接口图	适用范围
产品编号	R2056.8		 <p>1. Battery (+) / Bateria (+) 5. Power Coil / Bobina de Carga 2. GND / Masa 6. Power Coil / Bobina de Carga 3. Battery (+) / Bateria (+) 7. Power Coil / Bobina de Carga 4. GND / Masa</p>	2502 Honda VFR 800 1998 1999 31600-MBG-003 Moto Guzzi Calinia EV 1100 2003 2005 Moto Guzzi Calinia Stone 1100 2003 2004 Moto Guzzi MGS-01 Corsa 1200 2004 2011 Moto Guzzi Nevada 750 2002 2003 Moto Guzzi V11 Cafe Sport 1100
产品单重	克			
检测程序	M325 2502			
电线插头	25CM			
内盒尺寸	12*9.5*6CM			
外箱尺寸	49.5*25.5*30.5CM			
输出电压	14.5±0.5V 35安培			
一箱只数	50			
铝壳尺寸				
重要说明	3黄2红2绿			
产品编号	R2056.9		 <p>1. Battery (+) / Bateria (+) 5. Power Coil / Bobina de Carga 2. GND / Masa 6. Power Coil / Bobina de Carga 3. Battery (+) / Bateria (+) 7. Power Coil / Bobina de Carga 4. GND / Masa</p>	2494 Triumph Daytona 675 2006 2014 T1301234 Triumph Daytona 675 2006 2014 T1304040 Triumph Daytona 675 2006 2014 T1305123 Triumph Daytona R 675 2011 2014 T1305123 Triumph Sprint GT 1050 2010 2014 T1304040
产品单重	克			
检测程序	325 2494			
电线插头	20CM			
内盒尺寸	12*9.5*6CM			
外箱尺寸	49.5*25.5*30.5CM			
输出电压	14.5±0.5V 35安培			
一箱只数	50			
铝壳尺寸				
重要说明	3黄2红2绿			
产品编号	R2056.10		 <p>1. Battery (+) / Bateria (+) 5. Power Coil / Bobina de Carga 2. GND / Masa 6. Power Coil / Bobina de Carga 3. Battery (+) / Bateria (+) 7. Power Coil / Bobina de Carga 4. GND / Masa</p>	2509 Ducati Multistrada DS 1000 2003 2004 54040271A Ducati StreetFighter S 1099 2010 2011 540.4.019.1A Ducati StreetFighter S 1098 2012 540.4.019.1A Ducati StreetFighter S 848 2012 540.4.019.1A Ducati SuperBike STRICOLORE 1098 2007 540.4.019.1A
产品单重	克			
检测程序	325 2509			
电线插头	15 30CM			
内盒尺寸	12*9.5*6CM			
外箱尺寸	49.5*25.5*30.5CM			
输出电压	14.5±0.5V 35安培			
一箱只数	50			
铝壳尺寸				
重要说明	3黄2红2绿			
产品编号	R2056.11		 <p>1. Battery (+) / Bateria (+) 5. GND / Masa 2. GND / Masa 6. Power Coil / Bobina de Carga 3. Battery (+) / Bateria (+) 7. Power Coil / Bobina de Carga 4. Ignition Switch / Sensor 8. Power Coil / Bobina de Carga</p>	Aprilia RSV TUONO 1000 2006 2009 A 8127144 Aprilia RSV 1000 2004 2008 A 8127144 Reemlazo Shingen SH579GA
产品单重	克			
检测程序	M325 2492			
电线插头	黄1.5 X 25CM			
内盒尺寸	12*9.5*6CM			
外箱尺寸	49.5*25.5*30.5CM			
输出电压	14.5±0.5V 35安培			
一箱只数	50			
铝壳尺寸				
重要说明	3黄2红2绿			

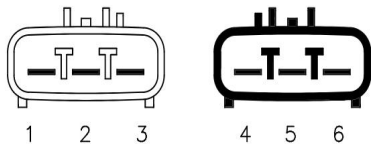

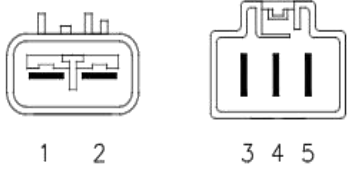



产品资料1		实物主图	接口图	适用范围
产品编号	R2056.12		 1. Battery (+) / Bateria (+) 5. GND / Masa 2. GND / Masa 6. Power Coil / Bobina de Carga 3. Ignition Switch / Sensor 7. Power Coil / Bobina de Carga 4. Battery (+) / Bateria (+) 8. Power Coil / Bobina de Carga	Honda CB SF X-11 1100 2000 2003 31600-MCC-601 Reem lazo Shin ngen SH579C-12
产品单重	克			
检测程序	M325			
电线插头	黄1.5 X 正检负20 黄线65CM			
内盒尺寸	12*9.5*6CM			
外箱尺寸	49.5*25.5*30.5CM			
输出电压	14.5±0.5V			
一箱只数	50			
铝壳尺寸				
重要说明	3黄2红2绿1黑检测			
产品编号	R2056.13		 1. Battery (+) / Bateria (+) 4. Power Coil / Bobina de Carga 2. GND / Masa 5. Power Coil / Bobina de Carga 3. Power Coil / Bobina de Carga	Jawa Daytona 4T 350 s 2012 SMDT250C-4 Jawa Ruta 40 4T 350 s 2012
产品单重	克			
检测程序	325 231			
电线插头	25CM			
内盒尺寸	12*9.5*6CM			
外箱尺寸	49.5*25.5*30.5CM			
输出电压	14.5±0.5V 35安培			
一箱只数	50			
铝壳尺寸				
重要说明	3黄1红1绿			
产品编号	R2056.14		 1. Battery (+) / Bateria (+) 5. GND / Masa 2. GND / Masa 6. Power Coil / Bobina de Carga 3. Ignition Switch / Sensor 7. Power Coil / Bobina de Carga 4. Battery (+) / Bateria (+) 8. Power Coil / Bobina de Carga	2402 Honda CBR 954 Firebla 900 2002 2003 31600-MCJ-750 Reem lazo Shin ngen SH678-DA 2403 Honda - 31600-MBG-D00 Honda CBR 1100 1999 2000 31600-MAT-E01 Honda CBR XX Blackbird 1100 1999 2000 31600-MAT-E01 Reem lazo Shin ngen SH579C-12
产品单重	克			
检测程序	M325 2402 2403			
电线插头	黄1.5 X 25CM			
内盒尺寸	12*9.5*6CM			
外箱尺寸	49.5*25.5*30.5CM			
输出电压	14.5±0.5V 35安培			
一箱只数	50			
铝壳尺寸				
重要说明	3黄2红2绿1黑检测			
产品编号	R2056.15		 1. GND 2. Battery (+) 3. GND 4. Battery (+) 5. Power Coil 6. Power Coil 7. Power Coil	2404 Honda CBR RR 929 2001 2003 31600-MCJ-641 Honda CBR RE 929 2001 2003 31600-MCJ-641 Reem lazo Shin ngen SH678C-13 2414 Honda CBR RR 600 2003 31600-MEE-003 Honda CBR RR 600 2004 2006 31600-MEE-872
产品单重	约280克			
检测程序	M325 2404 2414			
电线插头	黄1.5 X 45CM			
内盒尺寸	12*9.5*6CM			
外箱尺寸	49.5*25.5*30.5CM			
输出电压	14.5±0.5V 35安培			
一箱只数	50			
铝壳尺寸				
重要说明	3黄2红2绿			



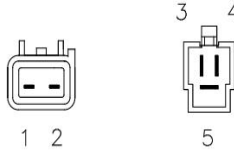

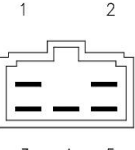

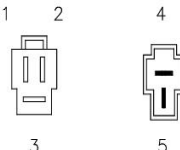
产品资料1		实物主图	接口图	适用范围
产品编号	R2056.16		 <p>1. GND 2. Battery (+) 3. Power Coil 4. Power Coil 5. Power Coil</p>	Honda CBR RR 1000 2004 2005 31600-MEL-013 Honda CBR RR 600 2007 2011 31600-MEL-821 Honda CBR RA 600 2009 2011 31600-MEL-821
产品单重	克			
检测程序	M325			
电线插头	黄1.5 X 25CM			
内盒尺寸	12*9.5*6CM			
外箱尺寸	49.5*25.5*30.5CM			
输出电压	14.5±0.5V			
一箱只数	50			
铝壳尺寸				
重要说明	3黄1红1绿			
产品编号	R2056.17		 <p>1. Battery (+) 2. Power Coil 3. GND 4. Power Coil 5. Power Coil</p>	Honda TRX FA/FGA 400 2004 2006 31600-HN7-003 Honda TRX FA/FGA 400 2007 31600-HN7-A21
产品单重	克			
检测程序	325 2465			
电线插头	5针插头			
内盒尺寸	12*9.5*6CM			
外箱尺寸	49.5*25.5*30.5CM			
输出电压	14.5±0.5V 35安培			
一箱只数	50			
铝壳尺寸				
重要说明				
产品编号	R2056.18		 <p>1. Power Coil 2. Power Coil 3. Power Coil 4. Battery (+) 5. GND</p>	YAMAHA R1 Yamaha YFM Grizzly 550 EM: 1D7-81960-00 Yamaha YZF R1 R6 BMW C600 647cc
产品单重	345克			
检测程序	M325			
电线插头	所有1.5 X 25CM			
内盒尺寸	12*9.5*6CM			
外箱尺寸	49.5*25.5*30.5CM			
输出电压	14.5±0.5V			
一箱只数	50			
铝壳尺寸				
重要说明				
产品编号	R2056.19		 <p>1. Battery (+) 2. GND 3. Power Coil 4. Power Coil 5. Power Coil</p>	Marca Mo lo Versión Cilindrada Año Cod. OEM Benelli Velvet 250 1999 2003 R51540071A0 MBK Skyliner 250 2000 2001 4JH-81960-01 eugeot Elyseo 125 737918 eugeot Elyseo 150 737918 eugeot Elystar 150 737918 eugeot Elystar 125 737918 eugeot Jetce 125 737918
产品单重	克			
检测程序	325			
电线插头	5针插头			
内盒尺寸	12*9.5*6CM			
外箱尺寸	49.5*25.5*30.5CM			
输出电压	14.5±0.5V			
一箱只数	50			
铝壳尺寸				
重要说明	5针插头			

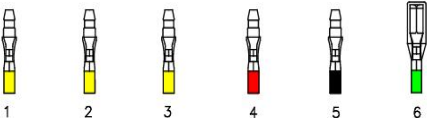

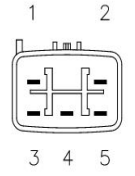

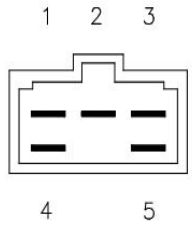

产品资料1		实物主图	接口图	适用范围
产品编号	R2056.20		 <p>1. Ignition Switch/ Sensor 2. Battery (+) / Bateria (+) 3. GND / Masa 4. Power Coil / Bobina de Carga 5. Power Coil / Bobina de Carga 6. Power Coil / Bobina de Carga</p>	31600-415-008 Honda CX500 31600-449-831 Honda CX500
产品单重	克			
检测程序	M325			
电线插头	黄1.5X 30 红绿25CM			
内盒尺寸	12*9.5*6CM			
外箱尺寸	49.5*25.5*30.5CM			
输出电压	14.5±0.5V			
一箱只数	50			
铝壳尺寸				
重要说明	3黄1红1绿1黑检测			
产品编号	R2056.21		 <p>1. Battery (+) / Bateria (+) 2. Ignition Switch/ Sensor 3. GND / Masa 4. Battery (+) / Bateria (+) 5. Power Coil / Bobina de Carga 6. GND / Masa 7. Power Coil / Bobina de Carga 8. Power Coil / Bobina de Carga</p>	2337 35A Honda GL L Goldwing 1200 1985 31600-MG9-951 Honda GL SEI Goldwing 1200 1986 31600-ML8-305
产品单重	克			
检测程序	M325 2337			
电线插头	黄1.5 X 25CM			
内盒尺寸	12*9.5*6CM			
外箱尺寸	49.5*25.5*30.5CM			
输出电压	14.5±0.5V 35安培			
一箱只数	50			
铝壳尺寸				
重要说明				
产品编号	R2056.22		 <p>1 GND / Masa 2 Battery (+) / Bateria (+) 3 GND / Masa 4 Battery (+) / Bateria (+) 5 Power Coil 6 Power Coil 7 Power Coil</p>	SUZUKI INTRU R 750 85-91 800 92-95
产品单重	克			
检测程序	M325			
电线插头	黄1.5 X 40CM			
内盒尺寸	12*9.5*6CM			
外箱尺寸	49.5*25.5*30.5CM			
输出电压	14.5±0.5V			
一箱只数	50			
铝壳尺寸				
重要说明				
产品编号	R2056.23		 <p>1 GND / Masa 2 Battery (+) / Bateria (+) 3 GND / Masa 4 Battery (+) / Bateria (+) 5 Power Coil 6 Power Coil 7 Power Coil 8 Ignition Sw itch / Sensor</p>	31600-MR6-000 31600-MK3-000 31600-MK7-008 Honda VF750C Magna RM30102 1982 HONDA 748cc VF750C Magna RM30102 1983 HONDA 748cc VF750C Magna RM30102 1984 HONDA 748cc VF750C Magna RM30102 1985 HONDA 748cc VF750C Magna RM30102 1986 HONDA 748cc
产品单重	克			
检测程序	M325			
电线插头	黄1.5X60, 红绿黑35CM			
内盒尺寸	12*9.5*6CM			
外箱尺寸	49.5*25.5*30.5CM			
输出电压	14.5±0.5V			
一箱只数	50			
铝壳尺寸				
重要说明				

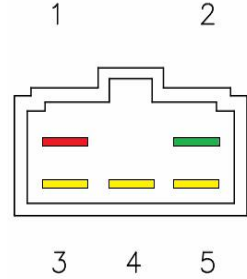

产品资料1		实物主图	接口图	适用范围
产品编号	R2056.24		 <p>1. Battery (+) 2. GND 3. Battery (+) 4. GND 5. Power Coil 6. Power Coil 7. Power Coil</p>	2508 Reem lazo Kokusan nki RX41 Suzuki - 32800-06G02 Suzuki DL V-Strom 1000 2010 2012 32800-06G01 Suzuki DL V-Strom 1000 2002 2009 32800-06G00
产品单重	克			
检测程序	M325 2508			
电线插头	黄1.5 X20CM			
内盒尺寸	12*9.5*6CM			
外箱尺寸	49.5*25.5*30.5CM			
输出电压	14.5±0.5V 35安培			
一箱只数	50			
铝壳尺寸				
重要说明	3黑2黑红2黑白			
产品编号	R2057.0		 <p>1. Battery (+) / Bateria (+) 2. Battery (+) / Bateria (+) 3. GND / Masa 4. GND / Masa 5. Power Coil / Bobina de Carga 6. Power Coil / Bobina de Carga 7. Power Coil / Bobina de Carga</p>	2552 Suzuki-32800-15H11 Suzuki-32800-15H01 SuzukiGSXHayabusa1300 2008 2012 32800-15H10 SuzukiGSXB-King1300 2008 201232800-15H00
产品单重	510克			
检测程序	M325 2552			
电线插头	黑1.5 X 35CM			
内盒尺寸	12*9.5*6CM			
外箱尺寸	49.5*25.5*30.5CM			
输出电压	14.5±0.5V 50安培			
一箱只数	50			
铝壳尺寸				
重要说明	3黑2黑红2黑白			
产品编号	R2057.1		 <p>1. Power Coil / Bobina de Carga 2. Power Coil / Bobina de Carga 3. Power Coil / Bobina de Carga 4. Battery (+) / Bateria (+) 5. GND / Masa</p>	JOHN DEERE MIU14344 XUV620I XUV625I JOHN DEERE MIU14344 XUV620I, and XUV625I Gators. 21066-0716 <p style="text-align: center; color: red; font-size: 1.2em;">一般都是5针的</p>
产品单重	510克			
检测程序	MOS50安培			
电线插头	3针+2针			
内盒尺寸	12*9.5*6CM			
外箱尺寸	49.5*25.5*30.5CM			
输出电压	14.5±0.5V			
一箱只数	50			
铝壳尺寸				
重要说明	5针插头			
产品编号	R2057.1X		 <p>1. Power Coil / Bobina de Carga 2. Power Coil / Bobina de Carga 3. Power Coil / Bobina de Carga 4. Battery (+) / Bateria (+) 5. AC Output / Salida AC 6. GND / Masa</p>	JOHN DEERE MIU14344 XUV620I XUV625I JOHN DEERE MIU14344 XUV620I, and XUV625I Gators. 21066-0716 John Deere XUV620I XUV625I Gators #MIU14344 MIU11409
产品单重	510克			
检测程序	MOS50安培			
电线插头	3针+3针			
内盒尺寸	12*9.5*6CM			
外箱尺寸	49.5*25.5*30.5CM			
输出电压	14.5±0.5V			
一箱只数	50			
铝壳尺寸				
重要说明	6针插头			

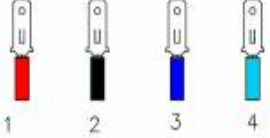

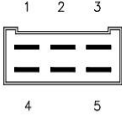

产品资料1		实物主图	接口图	适用范围
产品编号	R2057.2		 <p>1 2 3 4 5</p> <p>1. Battery (+) / Bateria (+) 2. GND / Masa 3. Power Coil / Bobina de Carga 4. Power Coil / Bobina de Carga 5. Power Coil / Bobina de Carga</p>	Suzuki - 32800-10G20 Suzuki AN Burgman 650 de 2003 a 2010 32800-10G00 Suzuki VLR Intruder 1800 de 2008 a 2011 32800-10G10 Suzuki VZ Boulevard 1500 de 2009 a 2010 32800-10G10 Suzuki VZ Marauder 1500 2009 32800-10G10 Suzuki VZR Intruder 1800 de 2006 a 2010 32800-10G00
产品单重	475克			
检测程序	M325 2596			
电线插头	所有1.5 X 25CM			
内盒尺寸	12*9.5*6CM			
外箱尺寸	49.5*25.5*30.5CM			
输出电压	14.5±0.5V 50安培			
一箱只数	50			
铝壳尺寸				
重要说明	78MM			
产品编号	R2057.3		 <p>1 2 3 4 5</p> <p>1. Battery (+) / Bateria (+) 2. GND / Masa 3. Power Coil / Bobina de Carga 4. Power Coil / Bobina de Carga 5. Power Coil / Bobina de Carga</p>	Polaris 4011731 4012476 4012930 4013587 Polaris 600 Dragon EFI 2009 Polaris 600 HO Cleanfire EFI 2007 Polaris 600 HO IQ Cleanfire EFI 2007 Polaris 600 HO IQ EFI 2007 Polaris 600 IQ Dragon EFI 2008 Polaris 600 IQ EFI 2008-2015 Polaris 600 IQ Shift EFI 2010-2012 Polaris 600 RMK 144 EFI 2010-2011 Polaris 600 RMK 155 EFI 2008/2010- OEM 4010886 4012611 Polaris 700 Classic Carb L/C -- 2006 Polaris 700 Classic Touring Carb L/C -- 2006 Polaris 700 Fusion EFI L/C -- 2006 Polaris 700 RMK Carb L/C -- 2006 Polaris 900 Fusion EFI L/C -- 2005-2006 Polaris 900 RMK EFI L/C -- 2005-2006 Polaris 900 Switchback EFI L/C -- 2006
产品单重	475克			
检测程序	M325			
电线插头	15 CM			
内盒尺寸	12*9.5*6CM			
外箱尺寸	49.5*25.5*30.5CM			
输出电压	14.5±0.5V			
一箱只数	50			
铝壳尺寸				
重要说明	78MM			
产品编号	R2057.4		 <p>1 2 3 4 5</p> <p>1. Power Coil / Bobina de Carga 2. Power Coil / Bobina de Carga 3. Power Coil / Bobina de Carga 4. Battery (+) / Bateria (+) 5. GND / Masa</p>	2474 Honda XR L Euro a 125 2003 2010 31600-KRH-D01 Honda XR LK Euro a 125 2011 2012 31600-KRH-921 Honda XR LEK Euro a 125 2011 2012 31600-KRH-921 Honda XR Argentina 125 s 2011 Reem lazo ietcard 1399 Reem lazo Shin ngen SH572LA
产品单重	475克			
检测程序	M325			
电线插头	15 CM			
内盒尺寸	12*9.5*6CM			
外箱尺寸	49.5*25.5*30.5CM			
输出电压	14.5±0.5V			
一箱只数	50			
铝壳尺寸				
重要说明	78MM			
产品编号	R2058.0		 <p>1 2 3 4 5</p> <p>1. Power Coil / Bobina de Carga 2. Power Coil / Bobina de Carga 3. Power Coil / Bobina de Carga 4. Battery (+) / Bateria (+) 5. GND / Masa</p>	2474 Honda XR L Euro a 125 2003 2010 31600-KRH-D01 Honda XR LK Euro a 125 2011 2012 31600-KRH-921 Honda XR LEK Euro a 125 2011 2012 31600-KRH-921 Honda XR Argentina 125 s 2011 Reem lazo ietcard 1399 Reem lazo Shin ngen SH572LA
产品单重	克			
检测程序	308 2474			
电线插头	15 25CM			
内盒尺寸	12*9.5*6CM			
外箱尺寸	49.5*25.5*30.5CM			
输出电压	14.5±0.5V 20安培			
一箱只数	50			
铝壳尺寸				
重要说明				

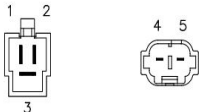

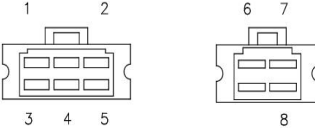
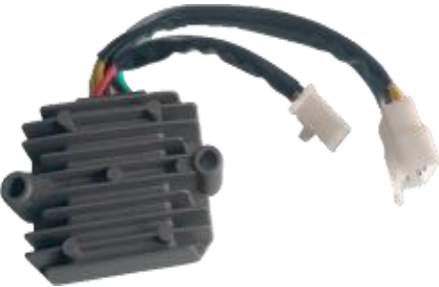
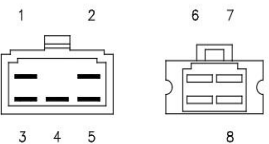

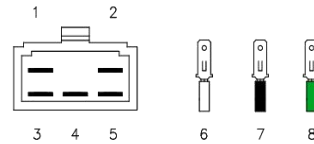
产品资料1		实物主图	接口图	适用范围
产品编号	R2058.1		 <p>1. GND / Masa 2. Battery (+) / Bateria (+) 3. Power Coil / Bobina de Carga 4. Power Coil / Bobina de Carga 5. Power Coil / Bobina de Carga</p>	2511 Kawasaki KLX R / SR 400 s 2004 21066-S005 Reem lazo Shin ngen SH572E-12 Suzuki DR-Z S 400 2000 2017 32800-29F00 Suzuki DR-Z 400 2000 2004 32800-08D00 Suzuki DR-Z E 400 2004 2007 32800-29F00 Suzuki RM X 250 1998 1999 32800-
产品单重	克			
检测程序	308 2511			
电线插头	25CM			
内盒尺寸	12*9.5*6CM			
外箱尺寸	49.5*25.5*30.5CM			
输出电压	14.5±0.5V 20安培			
一箱只数	50			
铝壳尺寸				
重要说明				
产品编号	R2058.2		 <p>1. Battery (+) / Bateria (+) 2. GND / Masa 3. Power Coil / Bobina de Carga 4. Power Coil / Bobina de Carga 5. Power Coil / Bobina de Carga</p>	Suzuki DR S 200 2015 2017 32800-19B11 Suzuki DR-Z 250 2001 2007 32800-13E10 Suzuki DR-Z 400 2009 32800-13E11 Suzuki LT QuadRunner 4WD 250 1987 1996 32800-19B10 Suzuki LT-F QuadRunner 160 1991 2001 32800-19B10 Suzuki LT-F QuadRunner 2WD 250 1999 2001 32800-19B11
产品单重	克			
检测程序	308 2400			
电线插头	20 CM			
内盒尺寸	12*9.5*6CM			
外箱尺寸	49.5*25.5*30.5CM			
输出电压	14.5±0.5V 20安培			
一箱只数	50			
铝壳尺寸				
重要说明				
产品编号	R2058.3		 <p>1. Power Coil / Bobina de Carga 2. Power Coil / Bobina de Carga 3. Power Coil / Bobina de Carga 4. GND / Masa 5. Battery (+) / Bateria (+)</p>	2408 20A Reem lazo Shin ngen SH572MB Suzuki AN 125 2000 32800-22D11 Suzuki AN Burgman 250 1996 2000 32800-22D10 Suzuki AN Burgman 125 1995 2000 32800-22D10 Suzuki EN 125 2004 2008 32800-22D20 Suzuki EN A2 125 32800-37G10-000 Suzuki GN 125 32800-37G10-000 Suzuki GSX 250 1991 1997 32800-
产品单重	克			
检测程序	308 2408 2396			
电线插头	20CM			
内盒尺寸	12*9.5*6CM			
外箱尺寸	49.5*25.5*30.5CM			
输出电压	14.5±0.5V 25安培			
一箱只数	50			
铝壳尺寸				
重要说明				
产品编号	R2058.4		 <p>1. Power Coil / Bobina de Carga (Yellow/ Amarillo) 2. Power Coil / Bobina de Carga (Yellow/ Amarillo) 3. Power Coil / Bobina de Carga (Yellow/ Amarillo) 4. Battery (+) / Bateria (+) (Red/ Rojo) 5. Ignition Switch/ Sensor (Black/ Negro) 6. GND/ Masa</p>	2478 Honda XR L 250 1991 1996 31600-KV6-670
产品单重	克			
检测程序	308 2478			
电线插头	黄线 20 红绿黑25CM			
内盒尺寸	12*9.5*6CM			
外箱尺寸	49.5*25.5*30.5CM			
输出电压	14.5±0.5V 20安培			
一箱只数	50			
铝壳尺寸				
重要说明				

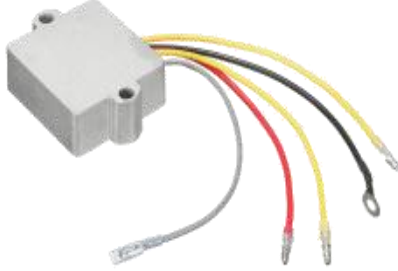

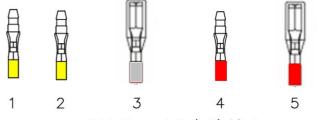

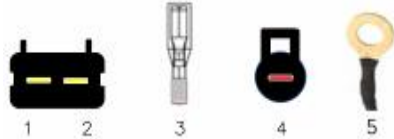
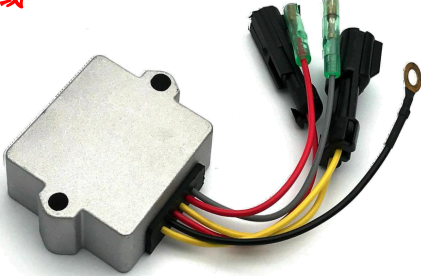
产品资料1		实物主图	接口图	适用范围
产品编号	R2058.5		 <ol style="list-style-type: none"> 1. Battery (+) / Bateria (+) 2. GND / Masa 3. Power Coil / Bobina de Carga 4. Power Coil / Bobina de Carga 5. Power Coil / Bobina de Carga 	2386 KawasakiKFXR450 2008 201321066-0042 KawasakiKFX400 2003 200621066-S004 KawasakiKFX400 2003 200621066-S011 KawasakiKXF450 2009 201121066-0042 KawasakiKXF250 2011 201221066-0042 SuzukiLT-F250201432800-05F20 SuzukiLT-F0zark250 2002 200932800-05F10 SuzukiLT-F0zark250 2007 200932800-05F20
产品单重	克			
检测程序	308 2386			
电线插头	6插只用5针			
内盒尺寸	100*85*30MM			
外箱尺寸	49.5*25.5*30.5CM			
输出电压	14.5±0.5V 20安培			
一箱只数	50			
铝壳尺寸				
重要说明				
产品编号	R2058.5.1		 <ol style="list-style-type: none"> 1. Battery (+) / Bateria (+) 2. GND / Masa 3. Power Coil / Bobina de Carga 4. Power Coil / Bobina de Carga 	Kawasaki Ultra JET SKI 150 1999 2005 21066-3715
产品单重	克			
检测程序	215 2385			
电线插头	6插只用4针			
内盒尺寸	100*85*30MM			
外箱尺寸	49.5*25.5*30.5CM			
输出电压	14.5±0.5V 20安培			
一箱只数	50			
铝壳尺寸				
重要说明				
产品编号	R2058.6		 <ol style="list-style-type: none"> 1. Battery (+) 2. Ignition 3. GND 4. Power Coil 5. Power Coil 	2505 Euromot Lucky HJ-2 110 Gilera QMT 10D Super 125 Gilera QMT 10A Speedy 125 Guerrero GMX 150 Guerrero Queen 125 IMSA Evo 110 series 2010 Jawa Supernova 150 Jianshe JS 6B 125 Jincheng JC 125 Konisa Vitality KE 250
产品单重	克			
检测程序	208 2405			
电线插头	5针插头			
内盒尺寸	100*85*30MM			
外箱尺寸	49.5*25.5*30.5CM			
输出电压	14.5±0.5V 12安培			
一箱只数	50			
铝壳尺寸				
重要说明				
产品编号	R2058.6A		 <ol style="list-style-type: none"> 1. Battery (+) 2. GND 3. Power Coil 4. Power Coil 5. Power Coil 	Honda CRF R 450 de 2017 a 2020 31600-KZL-931 Honda CRF RX 450 de 2017 a 2020 31600-KZL-931 Honda CRF RWE 450 de 2019 a 2020 31600-KZL-931 Honda CRF R ^o 250 de 2018 a 2020 31600-KZL-931 Honda NSC Vision 110 de 2011 a 2016 31600-KZL-931 Honda NSC Vision 50 de 2012 a 2015
产品单重	克			
检测程序	208 2602			
电线插头	5针插头			
内盒尺寸	100*85*30MM			
外箱尺寸	49.5*25.5*30.5CM			
输出电压	14.5±0.5V 20 A			
一箱只数	50			
铝壳尺寸				
重要说明				

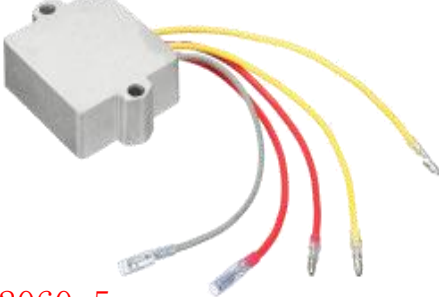
产品资料1		实物主图	接口图	适用范围
产品编号	R2058.7		 <ul style="list-style-type: none"> 1. GND / Masa 2. Power Coil / Bobina de Carga 3. Power Coil / Bobina de Carga 4. Battery (+) / Bateria (+) 	YamahaYFZ450 2012 20131 D-81960-00-00 YamahaYFZ450 2004 20095TG-81960-00-00
产品单重	克			
检测程序	HS08半波 CA+CC 2406			
电线插头	15CM小线			
内盒尺寸	100*85*30MM			
外箱尺寸	49.5*25.5*30.5CM			
输出电压	14.5±0.5V 12安培			
一箱只数	50			
铝壳尺寸				
重要说明				
产品编号	R2058.8		 <ul style="list-style-type: none"> 1. Battery (+) / Bateria (+) (Red / Rojo) 2. GND / Masa (Black / Negro) 3. Power Coil / Bobina de Carga (Blue / Azul) 4. Power Coil / Bobina de Carga (Light Blue / Celeste) 	2503 Cagiva Freccia C9 / C10 / C12 125 1982 1992 800042274 Cagiva K7 125 1989 1993 800042274 Cagiva Mito S 525 125 2007 2008 800042274 Cagiva Mito R 125 1994 1997 800042274 Cagiva Mito 125 1989 1994 800042274 Cagiva Mito Evolution 125 1994 2007 800042274
产品单重	克			
检测程序	208 2503			
电线插头	15CM			
内盒尺寸	100*85*30MM			
外箱尺寸	49.5*25.5*30.5CM			
输出电压	14.5±0.5V 12安培			
一箱只数	50			
铝壳尺寸				
重要说明				
产品编号	R2058.9		 <ul style="list-style-type: none"> 1. Power Coil / Bobina de Carga 2. Power Coil / Bobina de Carga 3. Power Coil / Bobina de Carga 4. Battery (+) / Bateria (+) 5. Ignition Switch / Sensor 6. GND / Masa 	Aprilia Classic 125 1995 1999 A 8112906 Aprilia Leonardo 150 1996 2004 A 8112906 Aprilia Leonardo 125 1996 2004 A 8112906 Aprilia MX 125 2004 2006 A 8112906 Aprilia egaso 650 1992 1995 A 8112434 Aprilia egaso 600 1990 1991 A 8112434
产品单重	克			
检测程序	308 2459			
电线插头	15 红黄20CM			
内盒尺寸	100*85*30MM			
外箱尺寸	49.5*25.5*30.5CM			
输出电压	14.5±0.5V 20安培			
一箱只数	50			
铝壳尺寸				
重要说明				
产品编号	R2058.10		 <ul style="list-style-type: none"> 1. Battery (+) / Bateria (+) 2. Power Coil / Bobina de Carga 3. Power Coil / Bobina de Carga 4. Power Coil / Bobina de Carga 5. GND (-) / Masa (-) 	2556 SuzukiLTQuadRunner230 1987 1993 32800-35B00
产品单重	克			
检测程序	315 2556			
电线插头	红黄15 黑线20CM小线			
内盒尺寸	100*85*30MM			
外箱尺寸	49.5*25.5*30.5CM			
输出电压	14.5±0.5V 20安培			
一箱只数	50			
铝壳尺寸				
重要说明				

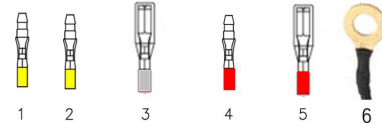
产品资料1		实物主图	接口图	适用范围
产品编号	R2058.11		 <p>1. Power Coil / Bobina de Carga 2. Power Coil / Bobina de Carga 3. Power Coil / Bobina de Carga</p> <p>4. GND / Masa 5. Battery (+) / Bateria (+)</p>	2575 Arctic CatATV2x4 / 4x4250 2001 2005 3530-034 Arctic CatATV2x4 / 4x4300 2001 2005 3530-034 Reem lazoShin ngenSH572A-1 SuzukiLT-FKingQuad 4WD300 1999 2002 32800-29B10 SuzukiLT-FQuadRunner 4WD250 1999 200232800-29B10
产品单重	克			
检测程序	315 2575			
电线插头	15CM小线			
内盒尺寸	100*85*30MM			
外箱尺寸	49.5*25.5*30.5CM			
输出电压	14.5±0.5V 20安培			
一箱只数	50			
铝壳尺寸				
重要说明				
产品编号	R2058.12			2489 Honda NX 250 1988 31600-KW3-000 Honda NX 250 1989 1993 31600-KW3-010 Reem lazo ietcard 1182
产品单重	克			
检测程序	315 2489			
电线插头	35CM小线			
内盒尺寸	100*85*30MM			
外箱尺寸	49.5*25.5*30.5CM			
输出电压	14.5±0.5V 20安培			
一箱只数	50			
铝壳尺寸				
重要说明				
产品编号	R2059.0		 <p>1. Field Coil / Bobina de Campo 2. Ignition Switch / Sensor 3. Power Coil / Bobina de Carga 4. Power Coil / Bobina de Carga</p> <p>5. Power Coil / Bobina de Carga 6. GND / Masa 7. Battery (+) / Bateria (+) 8. Ignition Switch / Sensor</p>	HONDA 31600-426-000, 31600-460-73, 31600426000, 3160046073
产品单重	267克			
检测程序	CB750+励磁			
电线插头	15 20 CM			
内盒尺寸	12*9.5*6CM			
外箱尺寸	49.5*25.5*30.5CM			
输出电压	14.5±0.5V			
一箱只数	50			
铝壳尺寸	6 公插			
重要说明	3黄1红正1绿负1白励磁 2 黑检测			
产品编号	R2059.1		 <p>1. Field Coil / Bobina de Campo 2. Ignition Switch / Sensor 3. Power Coil / Bobina de Carga 4. Power Coil / Bobina de Carga</p> <p>5. Power Coil / Bobina de Carga 6. GND / Masa 7. Battery (+) / Bateria (+) 8. Ignition Switch / Sensor</p>	2329 35A Honda CB F / C / K / SC 750 1981 1983 31600-MA6-000 Honda CB F / C 900 1981 1982 31600-MA6-000 Honda CB C / F / K / SC 750 1981 1983 31600-461-771 Honda CB C / F 900 1981 1982 31600-461-771 Honda CB C 900 1980 31600-MA6-910 Honda CB C 1000 1983 31600-MA7-008
产品单重	267克			
检测程序	CB750+励磁 2329 35安培 2538 25安培			
电线插头	15 20 CM			
内盒尺寸	12*9.5*6CM			
外箱尺寸	49.5*25.5*30.5CM			
输出电压	14.5±0.5V			
一箱只数	50			
铝壳尺寸	6插带钩			
重要说明	3黄1红正1绿负1白励磁 2 黑检测			

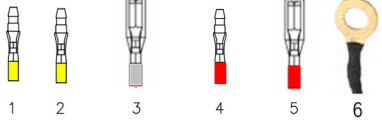
产品资料1		实物主图	接口图	适用范围
产品编号	R2059.2		 <p>1. Battery (+) / Bateria (+) 2. GND / Masa 3. Power Coil / Bobina de Carga 4. Power Coil / Bobina de Carga 5. Power Coil / Bobina de Carga 6. Field Coil / Bobina de Campo (White/ Blanco) 7. Ignition Switch / Sensor (Black/ Negro) 8. GND / Masa (Green/ Verde)</p>	1969-78 Honda REGULATOR RECTIFIER combo Rick's Electric cb750 cb550 cb500 cb400
产品单重	267克			
检测程序	CB750+励磁			
电线插头	25CM			
内盒尺寸	12*9.5*6CM			
外箱尺寸	49.5*25.5*30.5CM			
输出电压	14.5±0.5V			
一箱只数	50			
铝壳尺寸				
重要说明				
产品编号	R2059.3			Honda Cbr1000f 1987-1988 31600-mm5-000
产品单重	267克			
检测程序	308			
电线插头	15 25 70CM			
内盒尺寸	12*9.5*6CM			
外箱尺寸	49.5*25.5*30.5CM			
输出电压	14.5±0.5V			
一箱只数	50			
铝壳尺寸				
重要说明				
产品编号	R2060.1	5线带地线 	 <p>1. Yellow AC, 交流输入 2. Yellow AC, 交流输入 3. Gray Tach, 特殊功能线 4. Red B+, 正极输出 5. Black B-, 负极输出</p>	815279-3, 815279-5, 815279T, 830179-2, 830179T, 854515, 856748, 883072, 883072T, 8M0006034, 856748, 883072, 883072T, 1784M, 18-5743
产品单重	284克			
检测程序	QF2030C			
电线插头	15 CM			
内盒尺寸	125*120*44MM			
外箱尺寸				
输出电压				
一箱只数	50			
铝壳尺寸				
重要说明				
产品编号	R2060.2	六线 	 <p>1. Yellow AC, 交流输入 2. Yellow AC, 交流输入 3. Gray Tach, 特殊功能线 4. Red B+, 正极输出 5. Red Sense, 电压检测 6. Black B-, 负极输出</p>	MERCURY Mariner 883072 854515 856748 830179-2 8301792 883072T
产品单重	284克			
检测程序	QF2030C			
电线插头	15 CM			
内盒尺寸	125*120*44MM			
外箱尺寸				
输出电压				
一箱只数	50			
铝壳尺寸				
重要说明				

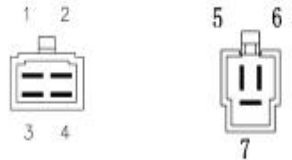
产品资料1		实物主图	接口图	适用范围
产品编号	R2060.3	五线  R2060.3	 1.Yellow AC,交流输入 2.Yellow AC,交流输入 3.Gray Tach,特殊功能线 4.Red B+,正极输出 5.Black B-,负极输出 R2060.3	Re laces: Mercury Marine®: 883072T2, 883072T 2, 893640, 883071T 1, 883071T1, 854515T2, 854515T 2, 893640T01, 883072T 1, 883072T1, 830179T1, 830179T2, CDI®: 194-3072K 1, 194-3072K1, 194-3072K-1, 194-2115K 1 Fits the following mo ls: Mercury & Mariner Outboard Motors: 25 h 25 (4-Stroke) (Serial # 0
产品单重	290克			
检测程序	QF2030C			
电线插头	15 CM			
内盒尺寸	125*120*44MM			
外箱尺寸				
输出电压				
一箱只数	50			
铝壳尺寸		六线  R2060.4	 1.Yellow AC,交流输入 2.Yellow AC,交流输入 3.Gray Tach,特殊功能线 4.Red B+,正极输出 5.Red Sense ,电压检测 6.Black B-,负极输出 R2060.4	Mercury 883072T2, 854515T2, 893640-002, 883071T1
重要说明				
产品编号	R2060.4			
产品单重	300克			
检测程序	QF2030C			
电线插头	15 CM			
内盒尺寸	125*120*44MM			
外箱尺寸				
输出电压				
一箱只数	50			
铝壳尺寸		5线带地线  R2060.5	 1.Yellow AC,交流输入 2.Yellow AC,交流输入 3.Gray Tach,特殊功能线 4.Red B+,正极输出 5.Red Sense ,电压检测 6.The shell B-,外壳负极输出 R2060.5	Mercury Mariner 815279 815279-1 815279-2 815279-3 815279-4
重要说明				
产品编号	R2060.5			
产品单重	300克			
检测程序	QF2030C			
电线插头	15 CM			
内盒尺寸	125*120*44MM			
外箱尺寸				
输出电压				
一箱只数	50			
铝壳尺寸		 R2060.6	 1.Yellow AC,交流输入 2.Yellow AC,交流输入 3.Gray Tach,特殊功能线 4.Red B+,正极输出 5.Red Sense,电压检测 6.Black B-, 负极输出 R2060.6	Mercury Mariner Outboard Voltage Regulator 854515 8M0045112 8m0050718
重要说明				
产品编号	R2060.6			
产品单重	净重245克			
检测程序	QF2030C			
电线插头	15 CM			
内盒尺寸	125*120*44MM			
外箱尺寸				
输出电压				
一箱只数	50			
铝壳尺寸				
重要说明				

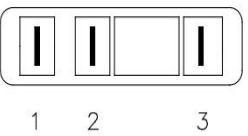
产品资料1		实物主图	接口图	适用范围
产品编号	R2060A.1		 <ol style="list-style-type: none"> 1.Yellow AC,交流输入 2.Yellow AC,交流输入 3.Gray Tach,特殊功能线 4.Red B+,正极输出 5.Red Sense,电压检测 6.Black B-, 负极输出 	1984-1996 (75, 85 & 90H - 3 Cyl.) 1988-1996 (115 & 130H - 4 Cyl.) 1984-1997 (150, 175, 200 & 225 H - 6 Cyl.) BHE197-6G5-A0 688-81960-61-00, 6G5-81960-A0-00
产品单重				
检测程序				
电线插头	15 CM			
内盒尺寸	125*120*44MM			
外箱尺寸				
输出电压				
一箱只数	50			
铝壳尺寸				
重要说明				
产品编号	R2061.0		 <ol style="list-style-type: none"> 1. Battery (+) / Bateria (+) 2. GND / Masa 3. Battery (+) / Bateria (+) 4. GND / Masa 5. Power Coil / Bobina de Carga 6. Power Coil / Bobina de Carga 7. Power Coil / Bobina de Carga 	Honda VTR250 INTERCE TOR 1988-1990 Honda VT250F 1983-1987 Honda VTZ250 1986-1988 Honda VFR400 (NC21) 1985-1987 Honda VFR400 (NC24) 1987-1988 sh583-12
产品单重	185克			
检测程序	325 暂停生产			
电线插头	20CM			
内盒尺寸	125*120*44MM			
外箱尺寸				
输出电压				
一箱只数	50			
铝壳尺寸				
重要说明				
产品编号	R2062.1			4013231 Polaris RZR 900 X RZR 4 900 X 2011 2012
产品单重	1460克			
检测程序	M325			
电线插头	所有1.5 X 35CM			
内盒尺寸	长23.5*宽17*高12CM			
外箱尺寸				
输出电压	14.5±0.5V			
一箱只数				
铝壳尺寸				
重要说明				
产品编号	R2063.1		 <ol style="list-style-type: none"> 1. Lighting Coil / Bobina de Luces 2. Lighting Circuit / Circuito de Luces 3. GND / Masa 	2479 Ducati - 343343 Ducati - 348362 Ducati - 348363 Fantic Rai r 50 23811006450 Morini KJ Kanguro 125 460560 iaggio Bravo 50 217424 iaggio Ves a X 125 161639 iaggio Ves a S / XL 125 217424 iaggio Ves a K 50 217424 iaggio Ves a T5 / ETS 125 217424
产品单重	克			
检测程序	CA 2479			
电线插头	所有1.5 X 25CM			
内盒尺寸	长23.5*宽17*高12CM			
外箱尺寸				
输出电压	14.5±0.5V 12安培			
一箱只数				
铝壳尺寸				
重要说明				





产品资料1		实物主图	接口图	适用范围
产品编号	R2063.2			AprILIA 8112200, 8138004, 8212120, A 8112331 BENELLI 51721400 CAGIVA 037038500, 061546750, 080546458, 42901, 48510005A, 54040011A, 800054017 DEUTZ 04191201, 04191231EC DUCATI 061046750, 061946750, 343520 GILERA 316788 LOMBARDINI 7362.018, 7362.022,
产品单重	净重300克 盒重330克			
检测程序	CA+CC 2544			
电线插头	所有1.5 X 25CM			
内盒尺寸	长23.5*宽17*高12CM			
外箱尺寸				
输出电压	14.5±0.5V 20安培			
一箱只数				
铝壳尺寸				
重要说明		R2063.2	R2063.2	2302 CA 12A
产品编号	R2064.1			Reem lazo Shin ngen SH588-12 Yamaha - 8H4-81910-50 Yamaha - 898-81910-12 Yamaha - 898-81910-11 Yamaha - 898-81910-10 Yamaha BR Bravo 250 1982 1987 82F-81910-A0 Yamaha BW Big Wheel 200 1985 1986 82F-81910-A0 Yamaha CF Inviter 300 1986 1988
产品单重	暂停生产			
检测程序	CA 2302			
电线插头	15CM			
内盒尺寸				
外箱尺寸				
输出电压	14.5±0.5V 12安培			
一箱只数				
铝壳尺寸				
重要说明		R2064.1	R2064.1	产品编号: 2101.8 单重/克
产品编号	R2065.1			DUCATI 1989 750 S ORT VOLTAGE REGULATOR RECTIFIER ASSY. (#47) 54040011A
产品单重	暂停生产			
检测程序	QF2101 同2101.8			
电线插头	15CM			
内盒尺寸	12*9.5*6CM			
外箱尺寸				
输出电压	14.5±0.5V			
一箱只数				
铝壳尺寸				
重要说明		R2065.1	R2065.1	2309 35A
产品编号	R2065.2			Ducati - Ducati 748 1997 Ducati 750 aso 1987 2001 Ducati 750 S ort 1987 2001 Ducati 750 F1 1987 2001 Ducati 750 SS 1987 2001 Ducati 851 1990 1993 Ducati 888 1990 1993 Ducati 900 ST2 1988 1998 Ducati 900 SSR 1989 1993
产品单重	暂停生产			
检测程序	QF2101 2309			
电线插头	所有1.5 X 25CM			
内盒尺寸	12*9.5*6CM			
外箱尺寸				
输出电压	14.5±0.5V 35安培			
一箱只数				
铝壳尺寸				
重要说明	3号线12\0	R2065.2	R2065.2	



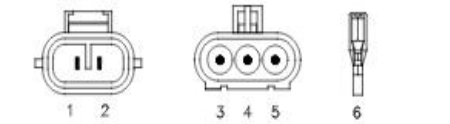
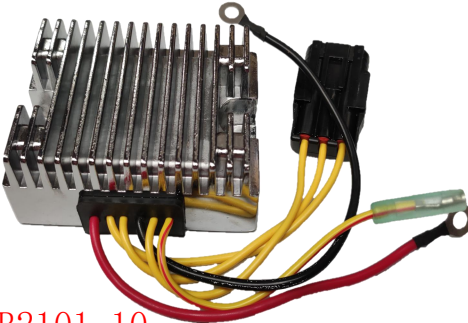
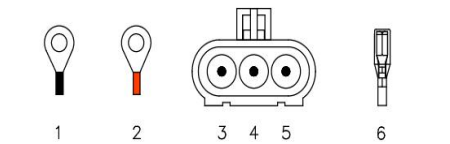

产品资料1		实物主图	接口图	适用范围
产品编号	R2066.1		 <ol style="list-style-type: none"> 1. Battery (+) / Bateria (+) 2. GND / Masa 3. Power Coil / Bobina de Carga 4. Power Coil / Bobina de Carga 5. Power Coil / Bobina de Carga 	SUZUKI GS X 150
产品单重				
检测程序	M25			
电线插头				
内盒尺寸	12*9.5*6CM			
外箱尺寸				
输出电压	14.5±0.5V			
一箱只数				
铝壳尺寸				
重要说明				
产品编号	R2067.1		 <ol style="list-style-type: none"> 1. Battery (+) / Bateria (+) 2. GND / Masa 3. Power Coil / Bobina de Carga 4. Power Coil / Bobina de Carga 5. Power Coil / Bobina de Carga 	2017 Honda CRF 250 R.
产品单重				
检测程序				
电线插头				
内盒尺寸	12*9.5*6CM			
外箱尺寸				
输出电压	14.5±0.5V			
一箱只数				
铝壳尺寸				
重要说明				
产品编号	R2068.1			凯旋 A021H0911 TRIUMPH Daytona 675 A087H1111 T1304040
产品单重				
检测程序	M325			
电线插头	黄线 1.5平方 线长 30CM			
内盒尺寸	12*9.5*6CM			
外箱尺寸				
输出电压	14.5±0.5V			
一箱只数				
铝壳尺寸				
重要说明				
产品编号	R2100.0			产品编号: 2100.0 YHC098 单重/1130克 孔距15.5CM 74505-97 74505-95 A 74505-97 498338 498273 49-8273 2112-0368 Harley Davidson All Touring 7450597 97-01
产品单重	1200			
检测程序	M60-1			
电线插头	所有3 X 交流60 正负120 CM			
内盒尺寸	20*16*10CM			
外箱尺寸				
输出电压	14.5±0.5V			
一箱只数				
铝壳尺寸	大壳子 安装孔距15.5CM			
重要说明				

产品资料1		实物主图	接口图	适用范围
产品编号	R2100.1	 <p>R2100.1 74505-06</p>	 <p>R2100.1</p>	产品编号: 2100.1 单重/克 孔距15.5CM 74505-06 74622-06 498269, 49-8269, 498276, 49-8276 74505-02 2112-0368 498273 49-8273 498338 Harley Davidson Electra Gli 1340 Classic FLTHC1340 2006-2008 Harley Davidson Electra Gli 1340 FLTH1340 2006-2008 Harley Davidson Electra Gli 1340 olice Mo 1 FLH 1340 2007 Harley Davidson Electra Gli 1340
产品单重	盒装重920克			
检测程序	M6010			
电线插头				
内盒尺寸	20*16*10CM			
外箱尺寸	54*45*35cm			
输出电压	14.5±0.5V			
一箱只数	20			
铝壳尺寸	大壳子 安装孔距15.5CM			
重要说明				
产品编号	R2100.2	 <p>R2100.2 74505-09</p>	 <p>R2100.2</p>	74505-09 74505-09A, H0505
产品单重	775克盒装重870克			
检测程序	M6010			
电线插头				
内盒尺寸	20X 16X 10CM			
外箱尺寸	55*45*35cm			
输出电压	14.5±0.5V			
一箱只数	20			
铝壳尺寸	小壳子			
重要说明	小壳子 安装孔距15CM			
产品编号	R2100.3	 <p>R2100.3 74505-04</p>	 <p>大</p> <p>R2100.3</p>	74505-04 2112-0811
产品单重	克			
检测程序	M60-1			
电线插头	所有3 X 交流35 正60 负70 CM			
内盒尺寸	20*16*10CM			
外箱尺寸	54*45*35cm			
输出电压	14.5±0.5V			
一箱只数	20			
铝壳尺寸	大壳子 安装孔距15.5CM			
重要说明				
产品编号	R2100.4	 <p>R2100.4 74505-02</p>	<p>R2100.4</p>	74505-02
产品单重	1050克			
检测程序	M60-1			
电线插头	所有3 X 交流35 正负120CM			
内盒尺寸	20*16*10CM			
外箱尺寸	54*45*35cm			
输出电压	14.5±0.5V			
一箱只数	20			
铝壳尺寸	大壳子 安装孔距15.5CM			
重要说明				

产品资料1		实物主图	接口图	适用范围
产品编号	R2101.0	 <p>R2101.0</p>	 <p>R2101.0</p>	产品编号: 2101.0 YHC113 单重: 净重450克 盒重480克 74711-08 74546-07A H4607 74711-c Harley Davidson 2007-2008 Sportster 883 1200 Harley Sportster XL883 Mo 1s 2009-2013 74711-08 H1108 Fitment: Harley Davidson Sportster XL883N 2013 Harley Davidson XL883C 2010 Harley Davidson XL883 2004
产品单重	480			
检测程序	M60-1			
电线插头	所有3 X 25CM			
内盒尺寸	12*9.5*6CM			
外箱尺寸				
输出电压	14.5±0.5V			
一箱只数				
铝壳尺寸	黑色喷塑+磨			
重要说明				
产品编号	R2101.1	 <p>74519-88</p> <p>R2101.1</p>	 <p>R2101.1</p>	Harley EVO 1989-1999 1340 Replacement 74519-88 74519-88A
产品单重	480克			
检测程序	M60-1			
电线插头	所有3 X 交流线25，正极线120CM			
内盒尺寸	12*9.5*6CM			
外箱尺寸				
输出电压	14.5±0.5V			
一箱只数				
铝壳尺寸	铝壳有缺口 要攻丝 黑色喷塑+磨			
重要说明				
产品编号	R2101.2	 <p>R2101.2 OEM 74518-99</p>	<p>重庆客户订做的。交流线1.6米长，正负极线25CM长、</p>  <p>R2101.2</p>	产品编号: 2101.2 YHC100 单重/730克 一箱只数 74518-99 74518-99A 74512-00 3135b Harley Davidson Dyna Glide Super Glide 1340 1999-2003 Heritage Softail 1450 2000 OEM Replacement.
产品单重	590			
检测程序	M60-1			
电线插头	所有3 X 交流线25 正负极120CM			
内盒尺寸	16*13*6CM			
外箱尺寸				
输出电压	14.5±0.5V			
一箱只数				
铝壳尺寸	黑色喷塑+磨			
重要说明				
产品编号	R2101.3	 <p>R2101.3</p>	 <p>1. Power Coil / Bobina de Carga 2. Power Coil / Bobina de Carga 3. Power Coil / Bobina de Carga 4. GND / Masa 5. Battery (+) / Bateria (+)</p> <p>R2101.3</p>	Can Am DS 650 2000 2002 278001554 Sea Doo 3D 1998 2004 278001554 Sea Doo GSX 1998 2004 278001554 Sea Doo GTI 2004 278001554 Sea Doo GTX 1998 2003 278001554 Sea Doo LRV 2002 2003 278001554 Sea Doo RX 2000 2002 278001554 Sea Doo Speedster LE DI 2004 278001554 Sea Doo X 2003 278001554
产品单重	460克			
检测程序	325 10148			
电线插头	所有1.5 X 25CM			
内盒尺寸	12*9.5*6CM			
外箱尺寸				
输出电压	14.5±0.5V 35安培			
一箱只数				
铝壳尺寸	黑色喷塑+磨			
重要说明				

产品资料1		实物主图	接口图	适用范围
产品编号	R2101.4		 <p>正极 是小插头</p>	产品编号: 2101.4 YHC101 单重/487克 74523-94A Harley Davidson 1994-2003 S ortster 74523-94 HARLEY-DAVIDSON S ORTSTER 883 XL883 Harley Davidson 74523-84A S ortster Harley Davidson S ortster XL1200 XL883 1994-2003 2004-2006 Harley Davidson XL 883/1200 S ortster
产品单重	440			
检测程序	M60-1			
电线插头	所有3 X 25CM			
内盒尺寸				
外箱尺寸				
输出电压	14.5±0.5V			
一箱只数				
铝壳尺寸	铝壳有缺口 要攻丝 黑色喷塑+磨			
重要说明	正极 是 小 插头			
产品编号	R2101.5			产品编号: 2101.5 单重/克 74523-04 49- 8325 21-0788 49-8251 Harley-Davidson S ortster XL1200C 2004 2005 2006 Harley-Davidson S ortster XL883 2004 2005 2006
产品单重	440			
检测程序	M60-1			
电线插头	所有3 X 25 正负35CM			
内盒尺寸	16*13*6CM			
外箱尺寸				
输出电压	14.5±0.5V			
一箱只数				
铝壳尺寸	铝壳有缺口 要攻丝 黑色喷塑+磨			
重要说明				
产品编号	R2101.6		 <p>黄线=交流输入 绿线=励磁线圈 红线=电瓶正极 外壳=接地</p>	产品编号: 2101.6 单重/克 74504-78 1979-1984 Harley Davidson XLS ROADSTER Re laces No.
产品单重	390克			
检测程序	暂停生产			
电线插头				
内盒尺寸				
外箱尺寸				
输出电压	14.5±0.5V			
一箱只数				
铝壳尺寸	铝壳有缺口 要攻丝 黑色喷塑+磨			
重要说明				
产品编号	R2101.7		 <p>1. Battery (+) / Batería (+) 2. GND / Masa 3. Power Coil / Bobina de Carga 4. Power Coil / Bobina de Carga</p>	Sea Doo 3D 2005 2007 278001969 Sea Doo Challenger 180 2005 2006 278001581 Sea Doo Challenger 230 2007 278001969 Sea Doo Challenger 180 2007 278001969 Sea Doo GTI 2005 2007 278001969 Sea Doo GTX 4-TEC 2002 2004 278001581 Sea Doo GTX 4-TEC 2004 2007 278001969 Sea Doo Islandia 220 2006 2007
产品单重	465克			
检测程序	M325 10147			
电线插头	所有1.5 X 25CM			
内盒尺寸	12*9.5*6CM			
外箱尺寸				
输出电压	14.5±0.5V 35安培			
一箱只数				
铝壳尺寸				
重要说明				

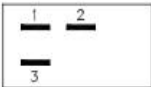
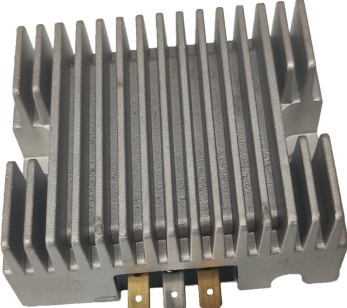
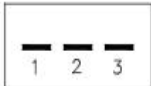
产品资料1		实物主图	接口图	适用范围
产品编号	R2101.8		 <p>1. Power Coil / Bobina de Carga (Yellow/ Amarillo) 2. Power Coil / Bobina de Carga (Yellow/ Amarillo) 3. Charge Lamp/ Lámpara Piloto 4. Battery (+) / Bateria (+) (Red/ Rojo) 5. GND/ Masa (Green/Verde)</p>	2309 35A Ducati - Ducati 748 1997 Ducati 750 aso 1987 2001 Ducati 750 S ort 1987 2001 Ducati 750 F1 1987 2001 Ducati 750 SS 1987 2001 Ducati 851 1990 1993 Ducati 888 1990 1993 Ducati 900 ST2 1988 1998 Ducati 900 SSR 1989 1993
产品单重	460			
检测程序	QF2101 2309			
电线插头	所有1.5 X 25CM			
内盒尺寸	12*9.5*6CM			
外箱尺寸				
输出电压	14.5±0.5V 35安培			
一箱只数				
铝壳尺寸				
重要说明	3号线12\0			
产品编号	R2101.9		 <p>1. GND / Masa 2. Battery (+) / Bateria (+) 3. Power Coil / Bobina de Carga 4. Power Coil / Bobina de Carga 5. Power Coil / Bobina de Carga 6. AC Output / Salida AC</p>	PolarisHawkeyeH0 2x4400 2011 2014 4012192 PolarisRanger400 2010 20144012192 PolarisScrambler4x4500 2010 2012 4012192 PolarisS ortsmanest500 2011 2013 4012192 PolarisS ortsmanH0 4x4400 2011 20144012192 PolarisS ortsmanTouring H0500 2010 20134012192
产品单重	468克			
检测程序	M325 2421			
电线插头	所有1.5 X 15CM			
内盒尺寸	12*9.5*6CM			
外箱尺寸				
输出电压	14.5±0.5V 25安培			
一箱只数				
铝壳尺寸	电镀白色铝壳			
重要说明	6号针是大号铜件			
产品编号	R2101.10		 <p>1. GND / Masa (Black/ Negro) 2. Battery (+) / Bateria (+) (Red/ Rojo) 3. Power Coil / Bobina de Carga 4. Power Coil / Bobina de Carga 5. Power Coil / Bobina de Carga 6. AC Output / Salida AC</p>	Polaris Hawkeye 2x4 / 4x4 300 2006 2011 4011182 Polaris S ortsman 4x4 300 2008 2010 4011182 Polaris S ortsman H0 4x4 400 2008 2010 4011182
产品单重	净重410克, 盒重440克			
检测程序	M325 2470			
电线插头	黄线1.5 X 15, 正负线25CM X 2			
内盒尺寸	12*9.5*6CM			
外箱尺寸				
输出电压	14.5±0.5V 25安培			
一箱只数				
铝壳尺寸	电镀白色铝壳			
重要说明	6号针是大号铜件			
产品编号	R2101.11			Harley Davidson Roadster XLS/S ortster XLH XLX 883 1000 1100 1200 1984-1990 OEM Re l.# 74523- 84/74523-84A / 74523-84T 74523-91
产品单重	净重440克			
检测程序	M60-1			
电线插头	所有3 X 交流25 正极线120 CM			
内盒尺寸	12*9.5*6CM			
外箱尺寸				
输出电压	14.5±0.5V			
一箱只数				
铝壳尺寸	铝壳有缺口 要攻丝 黑色喷塑+磨			
重要说明				

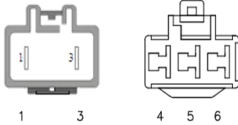





产品资料1		实物主图	接口图	适用范围
产品编号	R2101.12		 <p>1. Power Coil / Bobina de Carga 2. Power Coil / Bobina de Carga 3. Battery (+) / Bateria (+)</p> <p>Case / Carcasa : GND / Masa</p>	John Deere AM33845 John Deere AM37200 Kohler 237335 Kohler 4140306 Kohler 4140306S Reem lazo TRANS 0 JDR2256
产品单重	363克			
检测程序	215 2636			
电线插头				
内盒尺寸	12*9.5*6CM			
外箱尺寸				
输出电压	14.5±0.5V 15安培			
一箱只数				
铝壳尺寸	铝壳有缺口 要攻丝 黑色喷塑+磨			
重要说明	以后用黑色铝壳有缺口的 常用款式			
产品编号	R2101.12B		 <p>1. Power Coil / Bobina de Carga 2. Power Coil / Bobina de Carga 3. Battery (+) / Bateria (+)</p> <p>Case / Carcasa : GND / Masa</p>	John Deere AM33845 John Deere AM37200 Kohler 237335 Kohler 4140306 Kohler 4140306S Reem lazo TRANS 0 JDR2256
产品单重	363克			
检测程序	215 2636			
电线插头				
内盒尺寸	12*9.5*6CM			
外箱尺寸				
输出电压	14.5±0.5V 15安培			
一箱只数				
铝壳尺寸				
重要说明	白色铝壳, 一般不生产了, 除非定做			
产品编号	R2101.12A		 <p>1. Power Coil / Bobina de Carga 2. Battery (+) / Bateria (+) 3. Power Coil / Bobina de Carga</p> <p>Case / Carcasa : GND / Masa</p>	Briggs Stratton 390240 John Deere 4720 AM102596 Kohler 41-403-08S Kohler 4140309 Kohler 41-403-08 Kohler 2575503S Kohler 234279 Reem lazo TRANS 0 JDR4720 Tecumseh 610749 适用于Kohler AM102596 234279 2575503S 4140309 4140308
产品单重	363克			
检测程序	215 2635			
电线插头				
内盒尺寸	12*9.5*6CM			
外箱尺寸				
输出电压	14.5±0.5V 10A			
一箱只数				
铝壳尺寸	电镀白色铝壳			
重要说明				
产品编号	R2101.13		 <p>1. GND / Masa 3. Battery (+) / Bateria (+)</p> <p>4. Power Coil / Bobina de Carga 5. Power Coil / Bobina de Carga 6. Power Coil / Bobina de Carga</p>	Kazuma Jaguar 500cc 550 ATV, Steles, Velomotos 500cc ATV.
产品单重	410克			
检测程序	M325			
电线插头	所有1.5 X 25CM			
内盒尺寸	12*9.5*6CM			
外箱尺寸				
输出电压				
一箱只数				
铝壳尺寸	电镀白色铝壳			
重要说明				



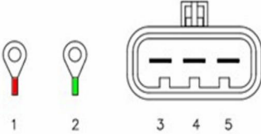

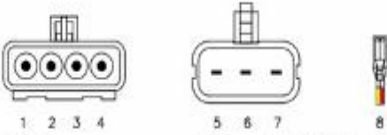

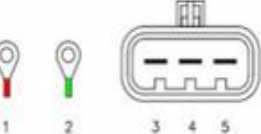
产品资料1		实物主图	接口图	适用范围
产品编号	R2101.14			40A 3-phase Charging Systems Com u- Fire 55402 22A Voltage Regulator Com u-Fire Black Finned 55121 Applications 1981 Harley Davidson FLTC Tour Gli Classic 1981 Harley Davidson FLHC Electra Gli Classic 1981 Harley Davidson FXS Low Ri r 1981 Harley Davidson FXB Sturgis
产品单重	570			
检测程序	M325			
电线插头	所有3 X35 75 CM			
内盒尺寸	12*9.5*6CM			
外箱尺寸				
输出电压	14.5±0.5V			
一箱只数				
铝壳尺寸	铝壳有缺口 要攻丝 黑色喷塑+磨			
重要说明				
产品编号	R2101.15			适用于: 2410209 Notes Year Make Mo l Submo l 2001 Victory V92C -- 2001 Victory V92C luxe 2000 Victory V92C -- 1999 Victory V92C -- 2001 Victory V92SC -- 2000 Victory V92SC -
产品单重	520			
检测程序	M325			
电线插头	所有3 X黄线25 红和黑线45CM			
内盒尺寸	12*9.5*6CM			
外箱尺寸	49.5*25.5*30.5CM			
输出电压	14.5±0.5V			
一箱只数	50			
铝壳尺寸	83*94*25.7MM			
重要说明				
产品编号	R2101.16			适用于: 710000257 Can-Am DS 650 / DS 650 Baja/DS 650 X 2002-2007
产品单重	462克			
检测程序	M325			
电线插头	所有1.5 X 25CM			
内盒尺寸	12*9.5*6CM			
外箱尺寸	49.5*25.5*30.5CM			
输出电压	14.5±0.5V			
一箱只数	50			
铝壳尺寸	83*94*25.7MM			
重要说明				
产品编号	R2101.17			适用于: 三相调节器整流器, 用于Rotax 2冲程发动 机 有一条黄线 未使用, 在的。一般不用 。供改三相用 (可替换264872)
产品单重	462克			
检测程序	M325			
电线插头	所有1.5 X 25CM			
内盒尺寸	12*9.5*6CM			
外箱尺寸	49.5*25.5*30.5CM			
输出电压	14.5±0.5V			
一箱只数	50			
铝壳尺寸	83*94*25.7MM			
重要说明				

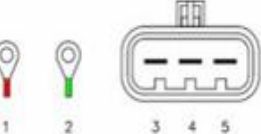



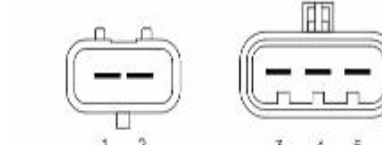

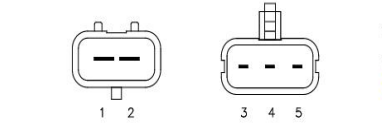
产品资料1		实物主图	接口图	适用范围
产品编号	R2101.18			2410094 98-02 VICTORY V92C 胜利整流器
产品单重	462克			
检测程序	M325			
电线插头	所有1.5 X 25CM			
内盒尺寸	12*9.5*6CM			
外箱尺寸	49.5*25.5*30.5CM			
输出电压	14.5±0.5V			
一箱只数	50			
铝壳尺寸	83*94*25.7MM			
重要说明				
产品编号	R2102.0		 <p>1. GND / Masa 2. Battery (+) / Bateria (+) 3. Power Coil / Bobina de Carga 4. Power Coil / Bobina de Carga 5. Power Coil / Bobina de Carga</p>	产品编号: 2102.0 YHC099 单重/990克 Harley art Numbers/ 74540-01 74610-01 J&N Electric art Numbers/ 230-22038 Trans o art Numbers/ H1001HARLEY-DAVIDSON Softail 2001-2006 HARLEY-DAVIDSON Dyna 2004-2005 HARLEY-DAVIDSON Fatboy 2001-2006 HARLEY-DAVIDSON Heritage Softail 2001-2006 HARLEY-DAVIDSON Heritage S ringer
产品单重	990			
检测程序	M6010			
电线插头	所有3 X 交流25 正负140 CM			
内盒尺寸	20X 16X 10CM			
外箱尺寸				
输出电压	14.5±0.5V			
一箱只数				
铝壳尺寸	有缺口			
重要说明				
产品编号	R2102.1		 <p>1. GND / Masa 2. Battery (+) / Bateria (+) 3. Power Coil / Bobina de Carga 4. Power Coil / Bobina de Carga 5. Power Coil / Bobina de Carga</p>	产品编号: 2102.1 YHC099 单重/克 Harley Davidson 2007 Softail Re 1 74540-07
产品单重	880			
检测程序	M6010			
电线插头	所有3 X 25CM			
内盒尺寸	20X 16X 10CM			
外箱尺寸				
输出电压	14.5±0.5V			
一箱只数				
铝壳尺寸	有缺口			
重要说明				
产品编号	R2102.2			产品编号: 2102.2 单重/克 74440-08
产品单重	750克			
检测程序	M6010			
电线插头	3针+2针			
内盒尺寸	20X 16X 10CM			
外箱尺寸				
输出电压	14.5±0.5V			
一箱只数				
铝壳尺寸	无 缺口			
重要说明				

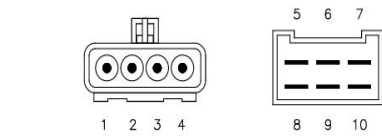

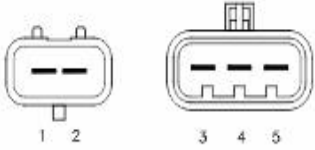



产品资料1		实物主图	接口图	适用范围
产品编号	R2102.3			74540-11单重/克 Drag S ecialties 2112-0811 Solid State Regulator Black 74540-08 H4008 49-8259 49-8277 498259 498277 HARLEY-DAVIDSON CHROME VOLTAGE REGULATOR 2008-2016 HERITAGE SOFTAIL FLSTC FLSTF FXSTFB 74567-11 Drag S ecialties 12V Solid-State Regulator 45/60A Harley Black 2112- 0811
产品单重	750克			
检测程序	M6010			
电线插头	3针+2针			
内盒尺寸	20X 16X 10CM			
外箱尺寸				
输出电压	14.5±0.5V			
一箱只数				
铝壳尺寸	无 缺口 插头是弯的			
重要说明				
产品编号	R2103.0			产品编号: 2103.0 单重/克 Harley Davidson 54AM Re laces art No. 74700012_3 74700012 HARLEY DAVIDSON S ORTSTER XL1200
产品单重	740			
检测程序	M60-1			
电线插头	2针+2针			
内盒尺寸	20X 16X 10CM			
外箱尺寸				
输出电压	14.5±0.5V			
一箱只数				
铝壳尺寸				
重要说明				
产品编号	R2104.0			74631-04
产品单重	860			
检测程序	M6010			
电线插头	所有3 X 20CM			
内盒尺寸				
外箱尺寸	49.5*36.5*62CM			
输出电压	14.5±0.5V			
一箱只数				
铝壳尺寸				
重要说明				
产品编号	R2104.1			Harley-Davidson Dyna CVO Fat Bob FXDFSE 2009 AHD6021-2 74631-08
产品单重	730			
检测程序	M6010			
电线插头				
内盒尺寸	20X 16X 10CM			
外箱尺寸	49.5*36.5*62CM			
输出电压	14.5±0.5V			
一箱只数				
铝壳尺寸				
重要说明				

产品资料1		实物主图	接口图	适用范围
产品编号	R2104.2		 <p>1. Battery (+) / Bateria (+) 2. GND / Masa 3. Power Coil / Bobina de Carga</p> <p>4. Power Coil / Bobina de Carga 5. Power Coil / Bobina de Carga</p>	产品编号: 2104.2 单重/860克 Harley Davidson 06-07 Dyna FXD/WG Re laces 74631-06 Harley_DavidsonFat_Boy_1580_Heritage_Softail_1584_1
产品单重	860			
检测程序	M6010			
电线插头	所有3 X 20CM			
内盒尺寸	20X 16X 10CM			
外箱尺寸	49.5*36.5*62CM			
输出电压	14.5±0.5V			
一箱只数				
铝壳尺寸				
重要说明				
产品编号	R2104.3			产品编号: 2104.3 单重/克 SMF Harley Davidson FXD Dyna olice GK 74594-02
产品单重	860			
检测程序	M60-1			
电线插头	所有3 X 30 80CM			
内盒尺寸	20X 16X 10CM			
外箱尺寸	49.5*36.5*62CM			
输出电压	14.5±0.5V			
一箱只数				
铝壳尺寸				
重要说明				
产品编号	R2104.4		<p>大</p>  <p>1. Battery (+) / Bateria (+) (Red/ Rojo) 2. GND / Masa 3. Power Coil / Bobina de Carga (Green/ Verde) 4. Power Coil / Bobina de Carga 5. Power Coil / Bobina de Carga</p>	74440-01 74494-02 Harley Davidson V-Rod Motorcycle VRSCA 2003-2005 Harley Davidson V-Rod Motorcycle VRSCB 2002-2005
产品单重	860			
检测程序	M6010			
电线插头	所有3 X 正30负 50 交流80CM			
内盒尺寸	20X 16X 10CM			
外箱尺寸	49.5*36.5*62CM			
输出电压	14.5±0.5V			
一箱只数				
铝壳尺寸				
重要说明	正极 是 大插头			
产品编号	R2105.0		 <p>1. Battery (+) / Bateria (+) (Red/ Rojo) 2. GND / Masa 3. Power Coil / Bobina de Carga (Green/ Verde) 4. Power Coil / Bobina de Carga 5. Power Coil / Bobina de Carga</p>	2535 Polaris Scrambler X 1000 2014 2016 4012678 Polaris Scrambler X 850 2014 4012678 Polaris Scrambler HO E S 850 2013 4012678 Polaris Scrambler850 2015 2016 4012678 Polaris S ortsman HL / MD 1000 2015 2016 4012678
产品单重	1130			
检测程序	M6010 2535 2537 2459			
电线插头	所有3 X 75CM			
内盒尺寸	20X 16X 10CM			
外箱尺寸	49.5*36.5*62CM			
输出电压	14.5±0.5V 50安培			
一箱只数				
铝壳尺寸	黑色铝壳			
重要说明	全部是黑线			



产品资料1		实物主图	接口图	适用范围
产品编号	R2105.0A		 <p>1. Battery (+) / Bateria (+) (Red/ Rojo) 2. GND / Masa 3. Power Coil / Bobina de Carga (Green/ Verde) 4. Power Coil / Bobina de Carga 5. Power Coil / Bobina de Carga</p>	2535 Polaris Scrambler X 1000 2014 2016 4012678 Polaris Scrambler X 850 2014 4012678 Polaris Scrambler HO E S 850 2013 4012678 Polaris Scrambler850 2015 2016 4012678 Polaris Sportsman HL / MD 1000 2015 2016 4012678
产品单重	1130			
检测程序	M6010 2535 2537 2459			
电线插头	所有3 X 红/黑/黄线140CM			
内盒尺寸	20X 16X 10CM			
外箱尺寸	49.5*36.5*62CM			
输出电压	14.5±0.5V 50安培			
一箱只数				
铝壳尺寸	黑色铝壳			
重要说明	3黄1 红1 黑			
产品编号	R2105.1		 <p>1. GND / Masa 2. GND / Masa 3. Battery (+) / Bateria (+) 4. Battery (+) / Bateria (+) 5. Power Coil / Bobina de Carga 6. Power Coil / Bobina de Carga 7. Power Coil / Bobina de Carga 8. AC Output / Salida AC</p>	Polaris Ranger 6x6 EFI 700 2007 2009 4011925 Polaris Ranger 4x4 EFI 700 2007 2009 4011925 Polaris Ranger 4x4 EFI 500 2008 2009 4011925 Polaris RZR EFI 800 2008 2009 4011925 Polaris RZR S EFI 800 2009 4011925 Polaris Sportsman EFI 500 2008 2009 4011569
产品单重	1080			
检测程序	M6010 2532			
电线插头	20CM (黄线2 红黑1.5 ² 红黄)			
内盒尺寸	20X 16X 10CM			
外箱尺寸	49.5*36.5*62CM			
输出电压	14.5±0.5V 35安培			
一箱只数				
铝壳尺寸	黑色铝壳			
重要说明				
产品编号	R2105.1A		 <p>1. Battery (+) / Bateria (+) (Red/ Rojo) 2. GND / Masa 3. Power Coil / Bobina de Carga (Green/ Verde) 4. Power Coil / Bobina de Carga 5. Power Coil / Bobina de Carga</p>	Polaris Ranger 6x6 EFI 700 2007 2009 4011925 Polaris Ranger 4x4 EFI 700 2007 2009 4011925 Polaris Ranger 4x4 EFI 500 2008 2009 4011925 Polaris RZR EFI 800 2008 2009 4011925 Polaris RZR S EFI 800 2009 4011925 Polaris Sportsman EFI 500 2008 2009 4011569
产品单重	1080			
检测程序	M6010 2532			
电线插头	20CM (黄线2 红和黑1.5红黄线1)			
内盒尺寸	20X 16X 10CM			
外箱尺寸	49.5*36.5*62CM			
输出电压	14.5±0.5V 35安培			
一箱只数				
铝壳尺寸	白色铝壳			
重要说明				
产品编号	R2105.2		 <p>1. Battery (+) / Bateria (+) (Red/ Rojo) 2. GND / Masa 3. Power Coil / Bobina de Carga (Green/ Verde) 4. Power Coil / Bobina de Carga 5. Power Coil / Bobina de Carga</p>	Polaris ACE EFI EURO HD 570 2015 2016 4014029 Polaris ACE325 2014 4013904 Polaris ACE EFI / EURO / HD 325 2015 2016 4014029 Polaris ACE EFI 900 2016 4015229 Polaris RZR 4 X 900 2012 4013904 Polaris RZR X 1000 2015 4014029 Polaris RZR EFI 570 2012 4013904 Polaris RZR X EFI 900 2012 4013904
产品单重	1285			
检测程序	M6010 2535 2537 2459			
电线插头	所有3 X 红和黑75 黄线140CM			
内盒尺寸	20X 16X 10CM			
外箱尺寸	49.5*36.5*62CM			
输出电压	14.5±0.5V 50安培			
一箱只数				
铝壳尺寸	白色铝壳			
重要说明				



产品资料1		实物主图	接口图	适用范围
产品编号	R2105.2A		 <p>1. Battery (+) / Bateria (+) (Red/ Rojo) 2. GND / Masa 3. Power Coil / Bobina de Carga 4. Power Coil / Bobina de Carga 5. Power Coil / Bobina de Carga</p>	2535 Polaris Scrambler XP 1000 de 2014 a 2016 4012678 Polaris Scrambler XP 850 2014 4012678 Polaris Scrambler HO EPS 850 2013 4012678 Polaris Scrambler 850 de 2015 a 2016 4012678 Polaris Sportsman HL / MD 1000 de 2015 a 2016 4012678 Polaris Sportsman Touring EPS 550 de
产品单重	1130			
检测程序	M6010 2535 2537 2459			
电线插头	所有3 X 75CM			
内盒尺寸	20X 16X 10CM			
外箱尺寸	49.5*36.5*62CM			
输出电压	14.5±0.5V 50安培			
一箱只数				
铝壳尺寸	白色铝壳			
重要说明				
产品编号	R2105.3		 <p>1. Battery (+) / Bateria (+) 2. GND / Masa 3. Power Coil / Bobina de Carga 4. Power Coil / Bobina de Carga 5. Power Coil / Bobina de Carga</p>	Polaris Ranger X 900 2013 2015 4013978 Polaris Ranger Crew 900 2014 2015 4013978 Polaris RZR 60 inch 900 2015 4013978
产品单重	1080			
检测程序	M6010 2536			
电线插头	所有3 X 40CM			
内盒尺寸	20X 16X 10CM			
外箱尺寸	49.5*36.5*62CM			
输出电压	14.5±0.5V 50安培			
一箱只数				
铝壳尺寸	黑色铝壳			
重要说明				
产品编号	R2105.4		 <p>1. Battery (+) / Bateria (+) 2. GND / Masa 3. Power Coil / Bobina de Carga 4. Power Coil / Bobina de Carga 5. Power Coil / Bobina de Carga 6. AC Output / Salida AC</p>	Polaris RZR EFI 800 2010 4012748 Polaris RZR S EFI 800 2010 4012748 Polaris Ranger Crew 500 2011 2013 4012748 Polaris Ranger EFI 800 2010 4012748 Polaris Ranger EFI 500 2010 2011 4012748 Polaris Sportsman est 800 2012 2013 4012748 Polaris Sportsman EFI 800 2010 2014 4012748
产品单重	1080			
检测程序	M6010			
电线插头	2 X 20CM (红黄线1 平方)			
内盒尺寸	20X 16X 10CM			
外箱尺寸	49.5*36.5*62CM			
输出电压	14.5±0.5V 35安培			
一箱只数				
铝壳尺寸	白色铝壳			
重要说明				
产品编号	R2105.5		 <p>1. GND / Masa 2. GND / Masa 3. Battery (+) / Bateria (+) 4. Battery (+) / Bateria (+) 5. Power Coil / Bobina de Carga 6. Power Coil / Bobina de Carga 7. Power Coil / Bobina de Carga 8. Power Coil / Bobina de Carga 9. Power Coil / Bobina de Carga 10. Power Coil / Bobina de Carga</p>	Polaris Indy Frontier 800 2002 4010538 Polaris Sportsman EFI 700 2005 2006 4011100 Polaris Sportsman EFI 800 2005 2006 4011100 Polaris Trail Frontier Classic 780 2003 2004 4010538 Polaris Trail Frontier Touring 780 2003 2005 4010538
产品单重				
检测程序	M6010 2533			
电线插头	(黄线2 红黑1.5) X 20CM			
内盒尺寸	20X 16X 10CM			
外箱尺寸	49.5*36.5*62CM			
输出电压	14.5±0.5V 35安培			
一箱只数				
铝壳尺寸	黑色铝壳			
重要说明				







产品资料1		实物主图	接口图	适用范围
产品编号	R2105.6		 <p>1. Battery (+) / Bateria (+) 2. GND / Masa 3. Power Coil / Bobina de Carga 4. Power Coil / Bobina de Carga 5. Power Coil / Bobina de Carga</p>	Polaris Sportsman X 850 2009 4011636 Polaris Sportsman Touring ES 550 2010 4011636 Polaris Sportsman Touring ES 850 2010 4011636 Polaris Sportsman X 550 2009 4011636 Polaris Sportsman X2 550 2010 4011636
产品单重	1280			
检测程序	M6010 2550			
电线插头	所有3 X 正负线20 黄线140CM			
内盒尺寸	20X 16X 10CM			
外箱尺寸	49.5*36.5*62CM 和23.5X 16X 5CM			
输出电压	14.5±0.5V			
一箱只数				
铝壳尺寸	黑色铝壳			
重要说明				
产品编号	R2105.7			Polaris 4012718 4014300 Polaris Victory Boardwalk 2013-2015 Polaris Victory Gunner 2015-2017 Polaris Victory King in 2008-2012 Polaris Victory King in 8-Ball 2008-2011 Polaris Victory King in luxe 2008-2011 Polaris Victory King in Low 2009 Polaris Victory King in Tour 2008-2011
产品单重	净重850克			
检测程序	M6010			
电线插头	所有3 X 交流线25 正负线35CM			
内盒尺寸	20X 16X 10CM			
外箱尺寸	49.5*36.5*62CM			
输出电压	14.5±0.5V			
一箱只数				
铝壳尺寸	黑色铝壳			
重要说明				
产品编号	R2105.7A			2015 15 Indian 4014300 230-22246 INDIAN Motorcycles Chief Classic 2014 1811cc INDIAN Motorcycles Chief Classic 2015 1811cc INDIAN Motorcycles Chief Classic 2016 1811cc INDIAN Motorcycles Chief Classic 2017 1811cc INDIAN Motorcycles Chief Classic 2018 1811cc
产品单重				
检测程序	M6010			
电线插头	所有3X交流线25 正负线140CM			
内盒尺寸	20X 16X 10CM			
外箱尺寸	49.5*36.5*62CM			
输出电压	14.5±0.5V			
一箱只数				
铝壳尺寸	黑色铝壳			
重要说明	比2105.7多一个套管			
产品编号	R2105.8			2410337 Victory Kingpin 2004-2005 Victory Kingpin Deluxe 2005 Victory Kingpin Ness Signature Series 2005 Victory Vegas Ness Signature Series 2005 Victory Vegas 8 Ball 2005 Victory Vegas 2003-2005 2006 CA TOURING CRUISER ALL OPTIONS
产品单重	净重860克			
检测程序	M6010			
电线插头	所有3 X 30CM			
内盒尺寸	20X 16X 10CM			
外箱尺寸	49.5*36.5*62CM			
输出电压	14.5±0.5V			
一箱只数				
铝壳尺寸	黑色铝壳			
重要说明				



产品资料1		实物主图	接口图	适用范围
产品编号	R2105.9			Victory V92C Deluxe 02 V92TC 02 10-567 2112-1148
产品单重	1100			
检测程序	M6010			
电线插头	所有3X交流线25 正负线140CM			
内盒尺寸	20X 16X 10CM			
外箱尺寸	49.5*36.5*62CM			
输出电压	14.5±0.5V			
一箱只数				
铝壳尺寸	黑色铝壳			
重要说明				
产品编号	R2105.10			Polaris 4012717: Polaris Victory Cross Country 2010-2014 Polaris CROSS ROADS CUSTOM/CROSS COUNTRY ALL OPTIONS 2011 Polaris VISION ALL OPTIONS 2011
产品单重	1100			
检测程序	M6010			
电线插头	所有3X交流线30 正负线75 CM			
内盒尺寸	20X 16X 10CM			
外箱尺寸	49.5*36.5*62CM			
输出电压	14.5±0.5V			
一箱只数				
铝壳尺寸	黑色铝壳			
重要说明				
产品编号	J3002.1			Lifan KD 150 Lifan KD 250 Lifan KP 350 Lifan KPM Cafe 200 Lifan V16 160 Suzuki - 31800-33400 Suzuki - 31800-30B00 Suzuki DR SE 650 de 1992 a 1995 31800-49100 Suzuki DR SE 250 de 1990 a 1995 31800-49100
单重/克	135			
单盒规格				
阿里链接				
参考链接				
最大电流				
插针数量				
保护套				
检测机码	10437 10438			
产品编号	J3003.1			
单重/克	129			
单盒规格				
阿里链接				
参考链接				
最大电流				
插针数量				
保护套				
检测机码				
产品编号	J3003.1			







产品资料1		实物主图	接口图	适用范围
产品编号	J3003.3			北极星 4012001 4010947 Polaris SPORTSMAN 500 2006-2010 Polaris RANGER 500 4X4 EFI 2006-2012 Polaris Sportsman 450 2007 ATV For Polaris Sportsman 800 X2 EFI LE2008 ATV For Polaris Sportsman 570 EPS EFI 2014 ATV Fit Polaris Ranger XP 700 4x4 EFI LE 2007 ATV For Polaris Sportsman 570 HD EFI
单重/克	140			
单盒规格				
阿里链接				
参考链接				
最大电流				
插针数量				
保护套				
产品编号	J3003A.1			Starter Solenoid For Can Am Bombardier Outlander Renegade 400 500 650 1000 庞巴迪ATV BOMBARDIER All-Terrain Vehicle (ATV) DS650 2000 653cc 710-001-364 BOMBARDIER 710-000-111 BOMBARDIER 710-000-252 BOMBARDIER 515-176-011 BOMBARDIER 182800-3760 DENSO 182800-4050 DENSO
单重/克	148			
单盒规格				
阿里链接				
参考链接				
最大电流				
插针数量				
保护套				
产品编号	J3004.0			Yamaha YFM Grizzly 400 de 2007 a 2014 4SV-81940-00 Yamaha YFM Bruin 350 de 2004 a 2006 4SV-81940-00 Yamaha YFM Big Bear 400 de 2001 a 2012 4SV-81940-00 Yamaha YFM Raptor 660 de 2001 a 2005 4XE-81940-12 Yamaha YFM Bear Tracker 250 de 2000 a 2004 4XE-81940-12 Yamaha YFM Big Bear 250 de 2007 a
单重/克	110			
外箱规格	42*J30*25CM			
阿里链接				
参考链接				
插针数量				
保护套				
产品编号	J3004.0L			OEM: 4YR-81940-02 / 5JW-81940-00-02 4SV-81940-12-00 / 4YR-81940-00 4DN-81940-12 -10 -11 / 1D0-81940-02 Yamaha YBR XTZ Super tenere 1200cc (2012-2014) VK Viking professional 1000cc (2006-2011) XV Road star warrior 1700cc (2002-2004) FJR 1300cc (2006-2007) (2003-2005) XV Road star midnight warrior 1700cc
盒装单重	124克/盒			
外箱规格	40.5*31.5*22.5CM			
阿里链接				
参考链接				
最大电流	150A			
一箱总重	13KG			
安装螺丝	有带			
适用电压	12V			





产品资料1		实物主图	接口图	适用范围
产品编号	J3004.1			5HH-81940-00-00, 5HH-81940-01-00, 5HH-81940-02-00, 5TJ-81940-10-00, 5TJ-81940-11-00, 5TJ-81940-12-00 YAMAHA RAPTOR 660 YFM660 2001 2002 2003 2004 2005 YAMAHA GRIZZLY 350 YFM350 2007 2008 2009 ATV moto YAMAHA GRIZZLY 660 YFM660 2002-2008 ATV
单重/克	102			
单盒规格				
阿里链接				
参考链接				
最大电流				
插针数量				
保护套				
产品编号	J3004.1L			Yamaha YFZ450 YFZ 450 2004 2005 2006 2007 2008
单重/克	124克/盒			
单盒规格				
阿里链接				
参考链接				
最大电流				
插针数量				
保护套				
产品编号	J3004.0H			4BH-81940-00-00 4BH-81940-01-00, 4BH-81940-02-00 SMU6070
单重/克	124克/盒			
单盒规格				
阿里链接				
参考链接				
最大电流				
插针数量				
保护套				
产品编号	J3004.1H			Yamaha FJR 1300 de 2003 a 2005 5JW-81940-00 Yamaha RS VENTURE 900 de 2007 a 2014 4DN-81940-12 Yamaha RS NYTRO 900 de 2006 a 2007 4DN-81940-12 Yamaha RS RAGE 900 2005 4DN-81940-10 Yamaha RS VECTOR 900 de 2006 a 2009 4DN-81940-12 Yamaha RS VECTOR 900 2005 4DN-81940-11
单重/克	124克/盒			
单盒规格				
阿里链接				
参考链接				
最大电流				
插针数量				
保护套				







产品资料1		实物主图	接口图	适用范围
产品编号	J3005.0			Kodiak 4WD 450 de 2018 a 2019 5B4-81940-00 Yamaha YFM Kodiak EPS 450 de 2018 a 2020 5B4-81940-00 Yamaha YFM Kodiak 450 desde 2020 5B4-81940-00 Yamaha YXE Wolverine 700 de 2016 a 2020 5B4-81940-00 Yamaha YXR Viking 700 de 2014 a 2020 5B4-81940-00 Yamaha YXR Rhino 700 de 2008 a 2013
单重/克	118			
单盒规格				
阿里链接				
参考链接				
最大电流				
插针数量				
保护套				
	10423 10432 10433 10449 10450			
产品编号	J3005.0H			
单重/克	118			
单盒规格				
阿里链接				
参考链接				
最大电流				
插针数量				
保护套				
产品编号	J3005.1			SUZUKI TL1000R TL1000S VZ800 VZ800Z VL1501 Yamaha Rhino YXR660 YXR 660 ATV Quad 2007 2008 2009 SUZUKI TL1000R TL1000S 1997-2003 VZ800 VZ800Z MARAUDER 97-09 SUZUKI LTF250 QUAD RUNNER OZARK 03-09 DL1000 DL100K2 V-STROM SUZUKI 650 SV650 SV650S 1999-2008 Motorcycle NEW
单重/克	118			
单盒规格				
阿里链接				
参考链接				
最大电流				
插针数量				
保护套				
产品编号	J3005.2			
单重/克	99			
单盒规格				
阿里链接				
参考链接				
最大电流				
插针数量				
保护套				



产品资料1		实物主图	接口图	适用范围
产品编号	J3006.0			Kawasaki - 27010-1376 Kawasaki KFX 700 de 2004 a 2009 27010-0782 Kawasaki KVF Praire 4x4 700 de 2004 a 2006 27010-0782 Kawasaki KVF Brute Force 4x4 650 de 2005 a 2013 27010-0782 Kawasaki KVF Praire 650 de 2002 a 2003 27010-0782 Hero Hunk 150 35850-KR3-870S HONDA 900 CBR900RR 1993-1999 HONDA 800 VFR800 INTERCEPTOR 1998-2009 HONDA 1000 CBR1000RR 2004-2007 HONDA 1100 CBR1100XX 1500 GL1500C VALKYRIE 1997-2003 HONDA 600 CBR600 1991-1998 Honda VT750 SHADOW VT 750 Honda CBR900RR CBR 900 RR 1993-1999 1998 1997 1996 Kawasaki ZX6R ZX600 G1-2 98-99 Honda CBX 200 35850-KBB-900 / 35860 KGA-940 / 35850-KAS-930 / 35850-MF5751 / 35850-MCG-000 Honda CBX 150 35850-KBB-900 / 35860 KGA-940 / 35850-KAS-930 / 35850-MF5751 / 35850-MCG-000 Honda CBX Twister 250 35851-KBB-900 Honda CG Titan 125 35850-KBB-900 35860-KGA-940 Honda NX Sahara 350 35850-KBB-900 / 35860 KGA-940 / 35850-KAS-930 / Starter Relay For 31800-07D00 Starter Relay ATV For Bombardier DS650 Baja 2002 Starter Relay For Honda TRX500FA Rubicon 4x4 2001-2004 Starter Relay For Honda FL250 Odyssey 1977-1984 Starter Relay ATV For E-ton YXL150 Yukon 2000-2001 Starter Relay ATV For Cannondale Speed 2002
单重/克	105克11.1KG/件			
单盒规格				
阿里链接				
参考链接				
最大电流				
插针数量				
保护套				
320圈				
	J3006.0			
产品编号	J3006.1			Hero Hunk 150 35850-KR3-870S HONDA 900 CBR900RR 1993-1999 HONDA 800 VFR800 INTERCEPTOR 1998-2009 HONDA 1000 CBR1000RR 2004-2007 HONDA 1100 CBR1100XX 1500 GL1500C VALKYRIE 1997-2003 HONDA 600 CBR600 1991-1998 Honda VT750 SHADOW VT 750 Honda CBR900RR CBR 900 RR 1993-1999 1998 1997 1996 Kawasaki ZX6R ZX600 G1-2 98-99 Honda CBX 200 35850-KBB-900 / 35860 KGA-940 / 35850-KAS-930 / 35850-MF5751 / 35850-MCG-000 Honda CBX 150 35850-KBB-900 / 35860 KGA-940 / 35850-KAS-930 / 35850-MF5751 / 35850-MCG-000 Honda CBX Twister 250 35851-KBB-900 Honda CG Titan 125 35850-KBB-900 35860-KGA-940 Honda NX Sahara 350 35850-KBB-900 / 35860 KGA-940 / 35850-KAS-930 / Starter Relay For 31800-07D00 Starter Relay ATV For Bombardier DS650 Baja 2002 Starter Relay For Honda TRX500FA Rubicon 4x4 2001-2004 Starter Relay For Honda FL250 Odyssey 1977-1984 Starter Relay ATV For E-ton YXL150 Yukon 2000-2001 Starter Relay ATV For Cannondale Speed 2002
单重/克	105克11.1KG/件			
单盒规格				
阿里链接				
参考链接				
最大电流				
插针数量				
保护套				
	J3006.1			
产品编号	J3007.1			Starter Relay For 31800-07D00 Starter Relay ATV For Bombardier DS650 Baja 2002 Starter Relay For Honda TRX500FA Rubicon 4x4 2001-2004 Starter Relay For Honda FL250 Odyssey 1977-1984 Starter Relay ATV For E-ton YXL150 Yukon 2000-2001 Starter Relay ATV For Cannondale Speed 2002
单重/克	102			
单盒规格				
阿里链接				
参考链接				
最大电流				
插针数量				
保护套				
	J3007.1			
产品编号	J3007.2			Starter Relay For 31800-07D00 Starter Relay ATV For Bombardier DS650 Baja 2002 Starter Relay For Honda TRX500FA Rubicon 4x4 2001-2004 Starter Relay For Honda FL250 Odyssey 1977-1984 Starter Relay ATV For E-ton YXL150 Yukon 2000-2001 Starter Relay ATV For Cannondale Speed 2002
单重/克	125			
单盒规格				
阿里链接				
参考链接				
最大电流				
插针数量				
保护套				
	J3007.2			

产品资料1		实物主图	接口图	适用范围
产品编号	J3007.2.2			31800-07D00 JYM125YBR天剑 天戟 5VL-H1940-00 Starter Relay Solenoid ATV For Bombardier DS650 Baja 2002 Starter Relay Solenoid For Honda TRX500FA Rubicon 4x4 2001-2004 Starter Relay Solenoid For Honda FL250 Odyssey 1977-1984 Starter Relay Solenoid ATV For E-ton YXL150 Yukon 2000-2001 Starter Relay Solenoid ATV For
单重/克	115			
单盒规格				
阿里链接				
参考链接				
最大电流				
插针数量				
保护套				
	J3007.2.2			
产品编号	J3007.2.3			Honda 250 500
单重/克	125			
单盒规格				
阿里链接				
参考链接				
最大电流				
插针数量				
保护套				
	J3007.2.3			
产品编号	J3007.2.4			
单重/克	125			
单盒规格				
阿里链接				
参考链接				
最大电流				
插针数量				
保护套				
	J3007.2.4			
产品编号	J3007.2.5			Arrowhead Starter Relay SMU6180 Arctic Cat 366 FIS 4x4 2011 3313-464 ATV
单重/克	125			
单盒规格				
阿里链接				
参考链接				
最大电流				
插针数量				
保护套				
	J3007.2.5			







产品资料1		实物主图	接口图	适用范围
产品编号	J3007.3			Universal - CON CABLES Honda VT500 VT 500 Motor Cycle Bike 1983 1984 KAWASAKI EX250 NINJA 250R 1986-2012 Motorcycle Honda GL1100 gold wing Aspencade 1980-1983 Brand HONDA GL CX CBX CB VF 500 550 650 750 900 UNIVERSAL CON CABLES
单重/克				
单盒规格				
阿里链接				
参考链接				
最大电流				
插针数量				
保护套				
	J3007.3			
产品编号	J3008.0			Honda 400ex TRX 99-04 Yamaha Grizzly 600 YFM600 ATV Two Wire Start Solenoid Relay For 125/150ccm Motorcycle/scooter moped/ATV Honda Goldwing GL1000 1975-1979 HONDA TRX400EX FOURTRAX 1999-2004 CH125 ELITE 1984 Honda C70 1980 ;Honda Goldwing GL1000 1975-1979 ATV For Honda TRX 300 EX Fourtrax
单重/克	103			
单盒规格	42*31*24.5MM确认			
阿里链接				
参考链接				
最大电流				
插针数量				
保护套				
	J3008.0			
产品编号	J3008.0.1			Honda 250 TRX250EX SPORTRAX 2003-2008 ATV Honda TRX400EX TRX 400 EX FOURTRAX 1999-2004 NEW KAWASAKI 700 KZ700 1984 NEW 21164-005 35850-HM3- 000 Honda 350 D TRX350D FOURTRAX 4x4 1987 1988 1989 NEW
单重/克				
单盒规格	42*31*24.5MM			
阿里链接	https://detail.1688.com/offer/555			
参考链接				
最大电流				
插针数量				
保护套				
	J3008.0.1			
产品编号	J3008.0.2			Honda 250 TRX250EX SPORTRAX 2003-2008 ATV Honda TRX400EX TRX 400 EX FOURTRAX 1999-2004 KAWASAKI 700 KZ700 1984 NEW 21164-005 35850-HM3- 000 Honda 350 D TRX350D FOURTRAX 4x4 1987 1988 1989
单重/克	1J30元/盒装			
单盒规格	42*31*24.5MM			
阿里链接				
参考链接				
最大电流				
插针数量				
保护套				
	J3008.0.2			

产品资料1		实物主图	接口图	适用范围
产品编号	J3008.1			FXD CG Yamaha XS XS360 XS400 XS400R Maxim Seca Heritage XS500 ATV 70cc 110 150 250cc
单重/克	140			
单盒规格	42*31*24.5MM			
阿里链接				
参考链接				
最大电流				
插针数量				
保护套				
		J3008.1		
产品编号	J3008.1.1			HONDA TRX400EX TRX 400 EX FOURTRAX 1999 - 2004 ATV. USA!!
单重/克	140			
单盒规格	42*31*24.5MM			
阿里链接				
参考链接				
最大电流				
插针数量				
保护套				
		J3008.1.1		
产品编号	J3008.1.2			4KD-81940-00-00 3AY-81940-00-00 YAMAHA GRIZZLY 600 YFM600 1998 1999 2000 2001 ATV Honda 300 TRX300 FOURTRAX 1988-2000 Yamaha XV920 XV 920 Virago 1982 1983 HONDA: 35850-HC4-000, 35850-HA8-771 APRILIA RSV 1000R YAMAHA: 3AY-81940-00-00, 5GT-81940-00-00 5GT-81940-11-00, 5EH-81940-00-00, 3JN-82310-01-00, 3GD-82310-10-00
单重/克	140			
单盒规格				
阿里链接				
参考链接				
最大电流				
插针数量				
保护套				
		J3008.1.2		
产品编号	J3008.1.3			4KD-81940-00-00 3AY-81940-00-00 YAMAHA GRIZZLY 600 YFM600 1998 1999 2000 2001 ATV Honda 300 TRX300 FOURTRAX 1988-2000 Yamaha XV920 XV 920 Virago 1982 1983 HONDA: 35850-HC4-000, 35850-HA8-771 APRILIA RSV 1000R YAMAHA: 3AY-81940-00-00, 5GT-81940-00-00 5GT-81940-11-00, 5EH-81940-00-00, 3JN-82310-01-00, 3GD-82310-10-00
单重/克	140			
单盒规格				
阿里链接				
参考链接				
最大电流				
插针数量				
保护套				
		J3008.1.3		







产品资料1		实物主图	接口图	适用范围
产品编号	J3008.1.4			4KD-81940-00-00 3AY-81940-00-00 YAMAHA GRIZZLY 600 YFM600 1998 1999 2000 2001 ATV Honda 300 TRX300 FOURTRAX 1988-2000 Yamaha XV920 XV 920 Virago 1982 1983 HONDA: 35850-HC4-000, 35850-HA8-771 APRILIA RSV 1000R YAMAHA: 3AY-81940-00-00, 5GT-81940-00-00 5GT-81940-11-00, 5EH-81940-00-00, 3JN-82310-01-00, 3GD-82310-10-00 4FB-81940-00-00, 4FB-81940-00-00
单重/克	140			
单盒规格				
阿里链接				
参考链接				
最大电流				
插针数量				
保护套				
	J3008.1.4			
产品编号	J3008.2			4KD-81940-00-00 3AY-81940-00-00 YAMAHA GRIZZLY 600 YFM600 1998 1999 2000 2001 ATV Honda 300 TRX300 FOURTRAX 1988-2000 Yamaha XV920 XV 920 Virago 1982 1983 HONDA: 35850-HC4-000, 35850-HA8-771 APRILIA RSV 1000R YAMAHA: 3AY-81940-00-00, 5GT-81940-00-00 5GT-81940-11-00, 5EH-81940-00-00, 3JN-82310-01-00, 3GD-82310-10-00 4FB-81940-00-00, 4FB-81940-00-00
单重/克	110			
单盒规格				
阿里链接				
参考链接				
最大电流				
插针数量				
保护套				
	J3008.2			
产品编号	J3008.2.1			31800-15500 31800-15501 31800-31300 Suzuki DR 200 SE 1996-2004 Suzuki DR 250 1996-2004 Suzuki GR 650 Tempter 1983 Suzuki GS 1100G 1982-1983 Suzuki GS 700E 1984-1985 Suzuki GS 750E 1983 Suzuki GV 1200 Madura 1985-1986 Suzuki GV 1400 Cavalcade 1986-1988 Suzuki VS 700 Intruder 1986-1987 Suzuki VS 800 Intruder 1992-2005
单重/克	110			
单盒规格				
阿里链接				
参考链接				
最大电流				
插针数量				
保护套				
	J3008.2.1			
产品编号	J3008.4			Honda TRX350 TRX450 TRX500 TRX400 TRX90 TRX650 New
单重/克				
单盒规格				
阿里链接				
参考链接				
最大电流				
插针数量				
保护套				
	J3008.4			

产品资料1		实物主图	接口图	适用范围
产品编号	J3008.4A			Honda TRX350 TRX450 TRX500 TRX400 TRX90 TRX650 ATV
单重/克				
单盒规格				
阿里链接				
参考链接				
最大电流				
插针数量				
保护套				
		J3008.4A		
产品编号	J3008.5			Universal 12V Starter Relay / Solenoid Pit Monkey Quad Bike Scooter Motorcycle GY6母插
单重/克				
单盒规格				
阿里链接				
参考链接				
最大电流				
插针数量				
保护套				
		J3008.5		
产品编号	J3008.5.1			Hyosung GT650R GT250R GV650 GV250 GT250 GT650
单重/克				
单盒规格				
阿里链接				
参考链接				
最大电流				
插针数量				
保护套				
		J3008.5.1		
产品编号	J3008.8			HONDA TRX250TM TRX250 TM RECON 250 2005-2017
单重/克				
单盒规格				
阿里链接				
参考链接				
最大电流				
插针数量				
保护套				
		J3008.8		

产品资料1		实物主图	接口图	适用范围
产品编号	J3008.9			Honda TRX 400 EX Fourtrax 1999 2000 2001 2002 2003 2004
单重/克				
单盒规格				
阿里链接				
参考链接				
最大电流				
插针数量				
保护套				
	J3008.9			
	J3008.10			
单重/克				
单盒规格				
阿里链接				
参考链接				
最大电流				
插针数量				
保护套				
	J3008.10			
	J3008.11			
单重/克				
单盒规格				
阿里链接				
参考链接				
最大电流				
插针数量				
保护套				
	J3008.11			
	J3008.12			POLARIS PREDATOR 500 2003 2004 2005 2006
单重/克	134克/只 带包装盒重量			
单盒规格				
阿里链接				
参考链接				
最大电流				
插针数量				
保护套				
	J3008.12			

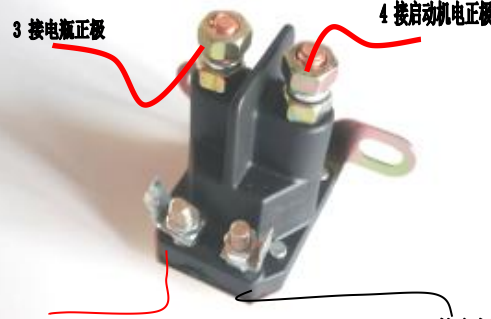
产品资料1		实物主图	接口图	适用范围
产品编号	J3008A.1			6G1-81941-10 36Y-81940-00 36Y-81940- 00-00 42X-81940- 00-00 YAMAHA FZ600 FZ700 FZ750 1985-1989 Motorcycle Yamaha Bike FJ1200 1986-1993 YAMAHA FZR1000 FZR 1000 1987-1995 Motorcycle YAMAHA XV250 VIRAGO ROUTE 66 1988-1990 1995-2008 Bike Yamaha FI 1100 from 1984 to 1985
单重/克	110			
单盒规格				
阿里链接				
参考链接				
最大电流				
插针数量				
保护套				
产品编号	J3008A.1.1			Yamaha FJ 1100 de 1984 a 1985 36Y-81940-00 Yamaha FJ 1200 de 1986 a 1992 36Y-81940-00 Yamaha FZ 700 1987 36Y-81940-00 Yamaha FZ 750 de 1985 a 1988 36Y-81940-00 Yamaha FZ 600 de 1986 a 1988 36Y-81940-00 Yamaha FZR 1000 de 1989 a 1995 36Y-81940-00
单重/克	110			
单盒规格				
阿里链接				
参考链接				
最大电流				
插针数量				
保护套				
产品编号	J3008A.2			OEM: 36Y-81940-00 Yamaha FJ 1100cc (1984 - 1985) FJ 1200cc (1986 - 1992) FZ 750cc (1985 - 1988) FZ 600cc (1986 - 1988) FZ 700cc (1987) FZR 400cc (1988 - 1990) FZR 1000cc (1989 - 1995) FZR 600cc (1989 - 1998) FZX FAZER 70cc0 (1986 - 1987)
单重/克	1J30克14.65KG/件			
单盒规格				
阿里链接				
参考链接				
最大电流				
插针数量				
保护套				
产品编号	J3008A.3			MS5C-311-1 6G1-91041-10-00 6G1-81941-10-00 Starter Relay Solenoid ARTCIC CAT TIGERSHARK 640 639cc 1993 1998 1999 PWC Starter Solenoid Relay Tiger Shark 640 770 900 1000 Starter Solenoid Relay TigerShark 640 770 900 1000 NEW YAMAHA XL700 XL 700 WAVE RUNNER 1999 2000 2001
单重/克	113			
单盒规格				
阿里链接				
参考链接				
最大电流				
插针数量	水星			
保护套				

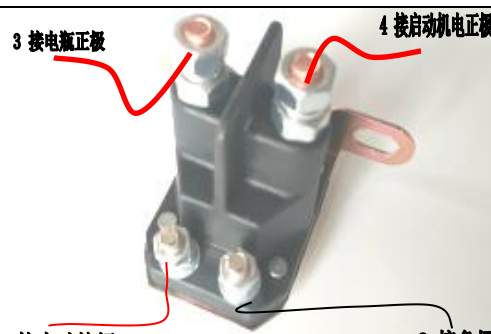





产品资料1		实物主图	接口图	适用范围
产品编号	J3008A.4			
单重/克	131			
单盒规格				
阿里链接				
参考链接				
最大电流				
插针数量				
保护套				
		J3008A.4		
产品编号	J3011.0			3085521 4011072 4011251 852-1221-210 Solenoid 12V 3 Terminal Polaris Predator Magnetic Switch Starter Solenoid Relay 90 500 Mouse over image to zoom 2004 Polaris Switchback 700 Snowmobile Starter Solenoid Polaris 500 Predator 2003 2004 2005 Solenoid Switch STARTER & RELAY SOLENOID FIT POLARIS XPLORER 400L 1996 1997 1998 /SPORT
单重/克	146			
单盒规格	70*70*80MM			
阿里链接				
参考链接				
插针数量				
保护套				
产品编号	J3011.1			J10011 AYP - 146154 AYP - 109081X AYP - 109946 Ariens - 03551000 Bolens - 1753539 Case - C33025 Case - C266525 Grasshopper - 184251 Grasshopper - 18425 Gravely - 044766
单重/克	146			
单盒规格	70*70*80MM			
阿里链接				
参考链接				
插针数量				
保护套				
产品编号	J3011.2			OEM:3085521 3087196 3087196 4010930 4011335 POLARIS STARTER RELAY SOLENOID SWITCH 250 300 400 500 STARTER SOLENOID RELAY FITS POLARIS SNOWMOBILE TRAIL RMK 2004 2009 2010 FITS POLARIS ATV SPORTSMAN 700 800 EFI 2005 2006 NEW SOLENOID FIT POLARIS ATP 330 4X4 2004 / SERIES 10 RANGER 500 6X6
单重/克	146			
单盒规格	70*70*80MM			
阿里链接				
参考链接				
最大电流				
插针数量				
保护套				
		J3011.2		





产品资料1		实物主图	接口图	适用范围
产品编号	J3011.3			J334 MTD - 725-0771
单重/克	146			
单盒规格	70*70*80MM			
阿里链接				
参考链接				
最大电流				
插针数量				
保护套				
	J3011.3			
产品编号	J3011.3.1			Polaris Magnum Sportsman 330 400 500 600 700 800 2410437 4011072 2410437 4011072 4011251 4011334 4012358
单重/克	146			
单盒规格	70*70*80MM			
阿里链接				
参考链接				
最大电流				
插针数量				
保护套				
	J3011.3.1			
产品编号	J3011.3.2			Polaris Magnum Sportsman 330 400 500 600 700 800 2410437 4011072 继电器
单重/克	146			
单盒规格	70*70*80MM			
阿里链接				
参考链接				
最大电流				
插针数量				
保护套				
	J3011.3.2			
产品编号	J3011.3.3			SPI Starter Solenoid Polaris Replaces OEM 2410437 3086236 4011334 4012358
单重/克	160			
单盒规格	70*70*80MM			
阿里链接				
参考链接				
最大电流				
插针数量				
保护套				
	J3011.3.3			



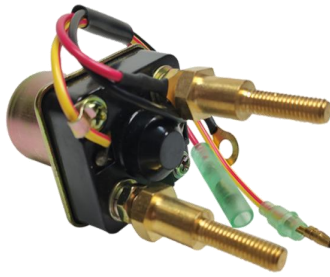

产品资料1		实物主图	接口图	适用范围
产品编号	J3011.4			J338 Tractor Stiga 1134-2946-01 J333 AMF Tractor 5716 AMF Tractor 52323 AYP - 110832x John Deere Tractor AM103290 MTD - 925-1426 / 725-1426 Shopper Tractor 18817 Snapper Tractor 75671 Snapper Tractor 7075671
单重/克	146			
单盒规格	70*70*80MM			
阿里链接				
参考链接				
最大电流				
插针数量				
保护套				
	J3011.4			
产品编号	J3011.5			J337 Tractor Stiga 1134-2946-02 J335 Tractor Castelgarden 18736100/0
单重/克	146			
单盒规格	70*70*80MM			
阿里链接				
参考链接				
最大电流				
插针数量				
保护套				
	J3011.5			
产品编号	J3011.6			OEM: 18736100/0 Tensión (voltage) 12 [V] Corriente (current) 200 [A] Tractor Castelgarden OEM: 1134-2946-02 Cub Cadet CC760ES, GT1054, GT1554 GT2000, GT2100, GTX1054 GTX2100, I1042, I1046 I1050, LGT1050, LGT1054 LGTX1050, LT1040, LT1042
单重/克	146			
单盒规格				
阿里链接				
参考链接				
最大电流				
插针数量				
保护套				
	J3011.6			
产品编号	J3011.6.1			OEM: 93265-9 812-1221-211 435-700 539101714 <hr/> 12V 812-1221-211, 93265-9, 93265 WR Stens 435-700, 539101714 启动继电器
单重/克	146			
单盒规格				
阿里链接				
参考链接				
最大电流				
插针数量				
保护套				
	J3011.6.1			

产品资料1		实物主图	接口图	适用范围
产品编号	J3011.7			J332
单重/克	146			Tractor AYP 146154
单盒规格				Tractor Ariens 35510
阿里链接				Tractor Bolens 1753539 / 1752137
参考链接				Tractor Gilson 212655
最大电流				Tractor Grasshopper 184251
插针数量				Tractor Gravely 45071
保护套				Tractor Lawn-Box 740207
		J3011.7	Tractor Snapper 1-8604	
产品编号	J3011.8			J336
单重/克	146			Tractor Bobcat 1530
单盒规格				Tractor Ransomes 1530
阿里链接				J331
参考链接				Ariens Tractor 3057700
最大电流				Bolens Tractor 1751569
插针数量				Dynamark Tractor 53716
保护套				MTD Tractor 725-0771 / 725-0530 / 925-0771
				J3011.8
产品编号	J3011.9			J330
单重/克	146			Ariens Tractor 35510
单盒规格				Bolens Tractor 1752137 / 173539
阿里链接				Case Tractor C-26525 / C-33025
参考链接				Exmark Tractor 1-513075
最大电流				Grasshopper Tractor 184251
插针数量				Gravely Tractor 45071
保护套				Simplicity Tractor 1700751 / 1671993 / 1685290
				J3011.9
			Wheel Horse Tractor 110116 / 110162 /	
产品编号	J3011.10			Briggs 555375GS 691656 745000 45000MA
单重/克	140克+盒子164.5			745001 790951 807829
单盒规格				
阿里链接				
参考链接				
最大电流				
插针数量				
保护套				
				J3011.10

产品资料1		实物主图	接口图	适用范围
产品编号	J3011.11			Replaces MTD, Cub Cadet, Troy-Bilt , Craftsman, White Outdoor OEM # 725-06153 725-06153A
单重/克	135克+盒子160			
单盒规格				
阿里链接				
参考链接				
最大电流				
插针数量				
保护套				
产品编号	J3011.12			4014655 Polaris GEM E2 -- 2016 Polaris GEM E4 -- 2016 Polaris GEM E6 -- 2016 Polaris General 1000 -- 2016-2017, 2019-2020 Polaris General 4 1000 -- 2018-2020 Polaris Ranger 1000 XP -- 2017-2019 Polaris Ranger 570 EFI F/C -- 2015- 2019 Polaris Ranger 570 XP -- 2016
单重/克	135克+盒子160			
单盒规格				
阿里链接				
参考链接				
最大电流				
插针数量				
保护套				
产品编号	J3014.0			YAMAHA AR240 SX240 SXT1800 2010-2012 ATV brand new
单重/克				
单盒规格				
阿里链接				
参考链接				
最大电流				
插针数量				
保护套				
产品编号	J3014.0A			Starter Relay Solenoid for Yamaha Outboards 68V-8194A-00-00
单重/克	105			
单盒规格				
阿里链接				
参考链接				
最大电流				
插针数量				
保护套				
		J3014.0A		

产品资料1		实物主图	接口图	适用范围
产品编号	J3014.1			J10348 Yamaha AR 230 1050 2004 68N-81940-00-00 Yamaha AR 210 1050 de 2003 a 2005 68N-81940-00-00 Yamaha FX 140 1050 de 2002 a 2004 68N-81940-00-00 Yamaha GP 1300 1300 de 2007 a 2008 68N-81940-00-00 Yamaha GP 800 800 de 2003 a 2004 68N-81940-00-00
单重/克				
单盒规格				
阿里链接				
参考链接				
最大电流				
插针数量				
保护套				
	J3014.1			
产品编号	J3014.2			SUZUKI QUADRACER 450 LT-R450 2006 2007 2008 2009 GRIZZLY 125 YFM125 2005-2013
单重/克	112克盒重			
单盒规格				
阿里链接				
参考链接				
最大电流				
插针数量				
保护套				
	J3014.2			
产品编号	J3014.3			Starter Relay Solenoid for Yamaha Grizzly YFM 600 1999-2001 5GT-81940-11-00
单重/克				
单盒规格				
阿里链接				
参考链接				
最大电流				
插针数量				
保护套				
	J3014.2			
产品编号	J3015.0			27010-3703 Kawasaki JF650 X2 650 1987-1990 4-wire long bolts
单重/克	192			
单盒规格				
阿里链接				
参考链接				
最大电流				
插针数量				
保护套	4条线			
	J3015.0			







产品资料1		实物主图	接口图	适用范围
产品编号	J3015.1			KAWASAKI JS650 650 SX 1992 1993 PWC NEW KAWASAKI JH750 750 SS 1992 1993 1994 1995 1996 1997 PWC KAWASAKI JS750 750 SXI PRO 1995-2002 PWC NEW KAWASAKI JS550 550 SX 1992 1993 1994 1995 PWC NEW
单重/克	155			
单盒规格				
阿里链接				
参考链接				
最大电流				
插针数量				
保护套	3条线			
	J3015.1			
产品编号	J3015.2			STARTER RELAY SWITCH FITS KAWASAKI JT1100 JETSKI 1100 STX D. I. 2003
单重/克	199			
单盒规格				
阿里链接				
参考链接				
最大电流				
插针数量				
保护套				
	J3015.2			
产品编号	J3015.3			POLARIS 250 350 2x4 4x4 6x6 1993 ATV NEW FITS POLARIS BIG BOSS 400 400L 6x6 1995 1996 1997 ATV Stator FITS POLARIS SPORTSMAN 500 Relay Solenoid 1998--2001 ATV Solenoid FITS POLARIS MAGNUM 325 2000 2001 2002 ATV NEW
单重/克	166			
单盒规格				
阿里链接				
参考链接				
最大电流				
插针数量				
保护套				
	J3015.3			
产品编号	J3015.3.1			1974 suzuki gt550 starter start relay 1982 SUZUKI GS850 (#201) STARTER SOLENOID START RELAY STARTING MOTOR SWITCH
单重/克	184			
单盒规格				
阿里链接				
参考链接				
最大电流				
插针数量				
保护套				
	J3015.3.1			









产品资料1		实物主图	接口图	适用范围
产品编号	J3015.4			STARTER RELAY SWITCH FITS KAWASAKI JH1200 JETSKI ULTRA 150 1999 2000 2001 2002
单重/克	183			
单盒规格				
阿里链接				
参考链接				
最大电流				
插针数量				
保护套				
		J3015.4		
产品编号	J3015.5			Starter Solenoid Relay FITS POLARIS SL750 SLT750 750 1994 1995 PWC NEW
单重/克	146			
单盒规格				
阿里链接				
参考链接				
最大电流				
插针数量				
保护套				
		J3015.5		
产品编号	J3015.6			Caltric STARTER RELAY SWITCH Fits KAWASAKI JH1100 JH-1100 JETSKI 1100 ZXI 2000-2003
单重/克				
单盒规格				
阿里链接				
参考链接				
最大电流				
插针数量				
保护套				
		J3015.6		
产品编号	J3016.0			OEM 35851-KBB-900 / 35850-KAS-930 / 35850-MF5-751 / 35850-MCG-000 / 35860-KGA-941 Arranque para motos sin fusible Starter for motorcycles without fuses KAWASAKI PRAIRIE 400 1998 1999 2000 2001 2002 STARTER SOLENOID RELAY FITS KAWASAKI BAYOU 400 4X4 1996 1997 1998 1999 STARTER SOLENOID RELAY FITS KAWASAKI PRAIRIE 300 1999 2000 2001 2002
单重/克	85克/只净重			
单盒规格				
阿里链接				
参考链接				
最大电流				
插针数量				
保护套				
		J3016.0		

产品资料1		实物主图	接口图	适用范围
产品编号	J3016.1			CAN-AM DS 650 DS650 X 2004 2005 2006 2007 CANAM
单重/克	117.7克			
单盒规格				
阿里链接				
参考链接				
最大电流				
插针数量				
保护套				
		J3016.1		
产品编号	J3016.2			KAWASAKI BRUTE FORCE 750 4X4I KVF750 2005-2014 2016 川崎启动
单重/克				
单盒规格				
阿里链接				
参考链接				
最大电流				
插针数量				
保护套				
		J3016.2		
产品编号	J3018.0			31800-41G10-000 2005 GSX-R1000 - ELECTRICAL 2006 GSX-R1000 - ELECTRICAL 2006 GSX-R600 - ELECTRICAL 2006 GSX-R750 - ELECTRICAL 2006 KingQuad (LT-A700X) - ELECTRICAL (F. NO. 5SAAP41A 67110001~)
净重/克	118.4			
单盒规格				
阿里链接				
参考链接				
最大电流				
插针数量				
保护套				
		J3018.0		
产品编号	J3018.0A			Starter Relay Solenoid Fit SUZUKI LTA400F SI KING QUAD 2010 2011 2012 S5S
净重/克	118.4			
单盒规格				
阿里链接				
参考链接				
最大电流				
插针数量				
保护套				
		J3018.0A		

产品资料1		实物主图	接口图	适用范围
产品编号	J3018.1			2002-2007 LT-A400 Eiger Auto/4X4/2X4 2002-2007 LT-A500 Vinson Auto/4X4/2X4 2002-2007 LT-F400 Eiger Manual/4X4/2X4 2002-2007 LT-F500 Vinson Manual/4X4/2X4 31800-03G00
单重/克				
单盒规格				
阿里链接				
参考链接	SuzukiLT-A400-LT-A500-LT-F400-LT-			
最大电流				
插针数量				
保护套				
		J3018.1		
产品编号	J3018.2			ARCTIC CAT ATV 400 DVX 2004-2008 400 DVX TONY STEWART EDITION 2006-2007
净重/克	1J30克			
单盒规格				
阿里链接				
参考链接				
最大电流				
插针数量				
保护套				
	底部有保险片	J3018.2		
产品编号	J3018.3			ARCTIC CAT 400 4X4 ACT VP AUTO MAN 1998-2005 ARCTIC CAT 500 4X4 TBX TRV AUTO MAN 1998-2003 SUZUKI: 31800-26E00 , 3180026E00, ARCTCO: 3530-001, ARROWHEAD, SMU6086
净重/克	128.3克			
单盒规格				
阿里链接				
参考链接				
最大电流				
插针数量				
保护套				
	底部有保险片	J3018.3	3018.3	
产品编号	J3121.0			J10347 278-001-376 278-001-802 Sea Doo Challenger 230 1500 de 2009 a 2012 278002347 Sea Doo Challenger 210 1500 de 2010 a 2012 278002347 Sea Doo Challenger 180 1500 de 2009 a 2012 278002347 Sea Doo GTI 155 1500 de 2014 a 2015 278003012 Sea Doo GTI 130 1500 de 2009 a 2013 278002347
净重/克	净重127克 盒重150克			
单盒规格				
阿里链接	3121.0阿里链接			
参考链接				
最大电流				
插针数量				
保护套				
		J3121.0		

产品资料1		实物主图	接口图	适用范围
产品编号	J3125.1			ARCTIC CAT ALL-TERRAIN VEHICLE (ATV) 1000 GT 2012 951CC ARCTIC CAT ALL-TERRAIN VEHICLE (ATV) 1000 LTD 2011 951CC ARCTIC CAT ALL-TERRAIN VEHICLE (ATV) 1000 MUD PRO 2010-2014 951CC ARCTIC CAT ALL-TERRAIN VEHICLE (ATV) 1000 TRV 2009-2010 951CC ARCTIC CAT ALL-TERRAIN VEHICLE (ATV) 1000 TRV CRUISER 2009-2011 951CC
净重/克	净重120克盒重140克			
单盒规格				
阿里链接				
参考链接				
最大电流				
插针数量				
保护套				
	J3125.1			
产品编号	J3126			游艇船通用继电器 折弯款 89-818864T 89-846070 89-94318 89-96158 直款 12V MERCURY MARINE SOLENOID FITS 89-96054T 3386M 89850189T 8991975 89850189 89-850187a1
净重/克	盒重151克			
单盒规格				
阿里链接				
参考链接				
最大电流				
插针数量				
保护套				
	J3126			
产品编号	3601		 <p>1 接 灯+</p> <p>2 接35V+输入</p> <p>3 接12V+输入</p>	适用于： 110克/只 1991-2008 Kawasaki Mule 1000 3020 OEM Fuel Pump Cut off Relay 27034-1053 川崎Mule 1000 3020 切断燃油泵继电器
单重/克	110克净重			
单盒规格				
阿里链接				
参考链接				
最大电流				
插针数量				
保护套				
	3601	3601		
产品编号	3901			38580-HW1-672 Honda MAIN RELAY ASSY ARX1200N ARX1200T AQUATRAX F-12 F-12X R-12 R-12X ARX
产品单重	248.5克			
检测机码				
导线长度				
内盒尺寸				
外箱尺寸				
输出电压				
一箱只数				
铝壳尺寸				
安装孔距				







产品资料1		实物主图	接口图	适用范围
产品编号	3701	 <p style="text-align: center; color: red; font-weight: bold;">3701</p>	 <p style="text-align: center; color: red; font-weight: bold;">3701</p>	JOHN DEERE Genuine OEM Ignition Delay Modul AM128906 345 425 445 GX345 1 割草机延时模块, 适用于 John Deere 345 GX345 425 445 , 包含:延时模块*1,
产品单重	60克			
检测机码				
导线长度	CM			
内盒尺寸	100*85*30MM			
外箱尺寸				
输出电压				
一箱只数				
铝壳尺寸				
安装孔距				
产品编号	3704	 <p style="text-align: center; color: red; font-weight: bold;">3704</p>		高尔夫球车 DS 高尔夫球车 1992-1996 fe290 fe350 RPM 转速限制器 1016511 101909401
产品单重	117克			
检测机码				
导线长度				
内盒尺寸	81X40X55MM			
产品尺寸	68X43X22MM			
输出电压				
一箱只数				
铝壳尺寸				
安装孔距				
产品编号	3704-97	 <p style="text-align: center; color: red; font-weight: bold;">3704-97</p>		高尔夫球车 DS 高尔夫球车 1997 fe290 fe350 RPM 转速限制器 1016511 101909401
产品单重	117克			
检测机码				
导线长度				
内盒尺寸	81X40X55MM			
产品尺寸	68X43X22MM			
输出电压				
一箱只数				
铝壳尺寸				
安装孔距				
产品编号	D100A.1	 <p style="text-align: center; color: red; font-weight: bold;">350直流二插</p> <p style="text-align: center; color: red; font-weight: bold;">100A.1</p>	 <p style="text-align: center; color: red; font-weight: bold;">100A.1</p>	适用于: YAMAHA YFM 350二驱 直流数字进角点火器 净重315克, 包装重量10只=3.2KG 5YT-85540-00-00 Yamaha YFM 350 Raptor 2004-2013 5NF-85540-00-00 Yamaha YFM Warrior 350 de 2002 a 2004
单重/克	298.4			
单盒规格				
阿里链接				
参考链接				
最大电流				
插针数量				
保护套				
是否限速	不限速			

产品资料1		实物主图	接口图	适用范围
产品编号	D100A.1.1	 <p>350交流二插</p>	 <p>100A.1.1</p>	适用于：交流点火器 Yamaha Kodiak 400 YFM400FA 4x4 2000 2001 5GH-85540-10-00 Yamaha Kodiak 400 YFM400FAH 4x4 Hunter Edition 2000 2001 Yamaha Kodiak 400 YFM400FAH 4x4 Realtree Xtra 2000 2001 Yamaha Kodiak 400 YFM400A 2000 YAMAHA YFM350X Warrior 350 348cc 1997-2001 3GD-85540-40-00 F8T34271
单重/克	300克			
阿里链接		 <p>350直流三插</p>	 <p>100A.1.2</p>	适用于：318克 参考CDI 1593 OEM: 5UH-85540-00-00 Yamaha YFM 350cc Bruin (2004-2006) Yamaha YFM 350cc Grizzly (2007-2013) Yamaha YFM 350cc Wolverine (2006-2009) Yamaha YFM 350cc Fas (2004) 有客户说 Yamaha YFM 350cc Grizzly (2007-2013)OEM号是 5LP-85540-20-00
单重/克	320克			
单盒规格		 <p>450直流三插</p>		适用于：350克 参考CDI 1600 OEM: 5ND-85540-10-00 Yamaha YFM Kodiak 450 de 2004 a 2006 Yamaha YFM Grizzly 450 2007
阿里链接				
产品编号	D100A.1.3	 <p>660直流三插</p>		适用于：350克 参考CDI 1591 OEM: 5KM-85540-00 5KM-85540-10-00 MOTO BISHI 02047 NORDIK MOTOR02047 PM02047-R00 ROUGH RIDER02047 5UG-85540-00-00 5UG-85540-10-00 2P5- 85540-00-00 Yamaha 660 YFM660F Grizzly 04 05 06 07 08 2004 2005 Yamaha 2002-03 YFM660R YFM 660 R 5LP-85540-20-00
单重/克	净重325克，盒重345克			
单盒规格				
阿里链接				
产品编号	D100A.1.4			
单重/克	350克			
单盒规格				
阿里链接				
参考链接				
最大电流				
插针数量				
保护套				
是否限速	不限速			



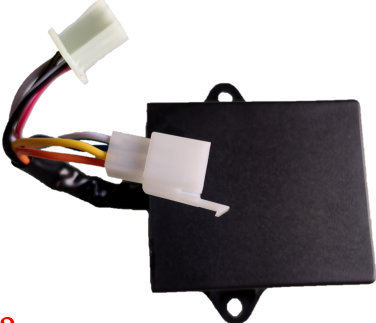
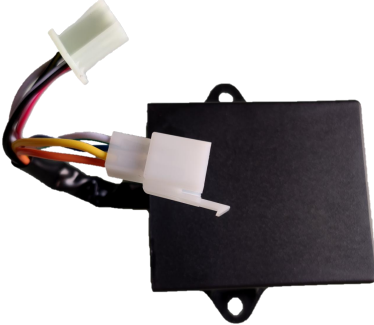

产品资料1		实物主图	接口图	适用范围
产品编号	D100A.1.5	 <p>100A.1.5 700直流三插</p>		适用于：克 参考CDI OEM: 33200-115-0000, 33200-055-0000, HISUN ATV UTV 400 500 700
单重/克	350克			
单盒规格				
阿里链接				
参考链接				
最大电流				
插针数量				
保护套				
是否限速				
产品编号	D100A.2	 <p>100A.2</p>	<p>点火器 39076-2051 是交流点火器：白线=触发；红线 接磁电机充电；黑线熄火线；棕色2 条是接地；黑黄线是接高压包</p> <p>100A.2</p>	适用于：100克/只 高尔夫球车点火 Club Car OEM REPL RPM Rev Limiter/Kawasaki 1990-1991 39076- 2051 1015923
单重/克	120克			
单盒规格				
阿里链接				
参考链接				
最大电流				
插针数量				
保护套				
产品编号	D100A.7	 <p>100A.2</p>	<p>100A.7</p>	适用于： 豪迈GY6 50 125 150cc 改装六线 沙滩车四冲车改装点火器 无限速仿GY6 巧格福喜RSZ鬼火迅鹰仿车 125
单重/克				
单盒规格				
阿里链接				
参考链接				
最大电流				
插针数量				
保护套				
产品编号	D100A.7.2	 <p>100A.2</p>	<p>100A.7.2</p>	适用于：ATV 豪迈GY6 50 125 150cc 改装六线 沙滩车四冲车改装点火器 无限速仿GY6 巧格福喜RSZ鬼火迅鹰仿车 125
单重/克				
单盒规格				
阿里链接				
参考链接				
最大电流				
插针数量				
保护套				

产品资料1		实物主图	接口图	适用范围		
产品编号	1702			适用于 72562-G01 替换 EPIGC107 Golf Cart CDI Boxes 1996 EZGO 黑白线 熄火 1. Killer/ Parada 白色线 电源 2. Source Coil / Bobina de Alimentación 橙色线 放电 3. Ignition Coil / Bobina de Ignición 黑色线 接地 4. GND / Masa 红白线 信号 5. Pick-Up Coil / Captor		
单重/克	112克					
单盒规格						
阿里链接						
参考链接						
最大电流						
插针数量						
保护套						
交流						
					1702	
产品编号	1702A			72872-G01 replacement - EPIGC108 for EZ GO 		
单重/克	112克					
单盒规格						
阿里链接						
参考链接						
最大电流						
插针数量						
保护套						
					1702A	
产品编号	1702dg					
单重/克	112克					
单盒规格						
阿里链接						
参考链接						
最大电流						
插针数量						
保护套						
直流		1702dg				
产品编号	1703			川崎点火器点火模块 21119-2161 21119-2095 m73484 m70114 约翰迪尔		
单重/克	克					
单盒规格						
阿里链接						
参考链接						
最大电流						
插针数量						
保护套					1703	

产品资料1		实物主图	接口图	适用范围
产品编号	1704			3GD-85540-20-00 Yamaha YFM Warrior 350 de 1990 a 1995
单重/克	盒重365克			
单盒规格				
阿里链接				
参考链接				
最大电流				
插针数量				
保护套				
检测码	10006			
外壳	大壳子			
产品编号	1705			3HN-85540-10-00 Yamaha Big Bear 350 YFM350FW 4x41990-1994 Yamaha Moto 4 YFM350ER 1992-1994
单重/克	净重316克			
单盒规格				
阿里链接				
参考链接				
最大电流				
插针数量				
保护套				
检测码				
产品尺寸	86.6X70.5X25.5 孔距85MM			
产品编号	1707			3GD-85540-30-00 Yamaha YFM Warrior 350 1996
单重/克	322克			
单盒规格				
阿里链接				
参考链接				
最大电流				
插针数量				
保护套				
检测码	1563			
产品尺寸	86.6X70.5X25.5 孔距85MM			
产品编号	1708			3GG-85540-10-00 Yamaha YFZ Banshee 350 desde 1997-2006
单重/克	300克盒 装重量			
单盒规格				
阿里链接				
参考链接				
最大电流				
插针数量				
保护套				
检测码	1557			
产品尺寸	86.6X70.5X25.5 孔距85MM			

产品资料1		实物主图	接口图	适用范围
产品编号	1710			3HN-85540-10-00 Yamaha ATV 1990 BIG BEAR 4WD - YFM350FWA Yamaha ATV 1991 BIG BEAR 4WD - YFM350FWB Yamaha ATV 1990 MOTO-4 - YFM350ERA Yamaha ATV 1991 BIG BEAR - YFM350FWB_MNH Yamaha ATV 1992 BIG BEAR (ME & NH Only) - YFM350FWD_MNH Yamaha ATV 1992 BIG BEAR 4WD -
单重/克	净重230克			
单盒规格				
阿里链接				
参考链接				
最大电流				
插针数量				
保护套				
检测码	1566			
产品编号	1712			21119-2157 21119-2116 AM105574 131800-0131 21119-2120 Kawasaki Mule FD501V FD590V FD611V FD620D FD661D John Deere Fit S3L5
单重/克	270克盒重			
单盒规格	150X95X50MM			
阿里链接				
参考链接				
最大电流				
插针数量				
保护套				
检测码	1566			
外壳	小壳子			
产品编号	1713			21119-2157 21119-2116 AM105574 131800-0131 21119-2120
单重/克	230克盒重			
单盒规格	100*85*30 MM			
阿里链接				
参考链接				
最大电流				
插针数量				
保护套				
检测码	1566			
产品尺寸	86.6X70.5X25.5 孔距85MM			
产品编号	1714			Can-am DS 50 2-Stroke -- 2002-2006 Can-am DS 90 2-Stroke -- 2002-2006 Can-am Quest 50 2-Stroke -- 2003 3301-135 Arctic Cat 2002-2004 90 2-Stroke Youth ATV 3301-595 A3041014500A A30410117001 A304101450AA A30410117002
单重/克	盒重70.5克			
单盒规格	77X55X50MM			
阿里链接				
参考链接				
最大电流				
插针数量				
保护套				
检测码				
产品尺寸				

产品资料1		实物主图	接口图	适用范围
产品编号	1715			POLARIS SCRAMBLER SPORTSMAN PREDATOR 50cc 90cc PERFORMANCE RACE IGNITION CDI BOX A190001-02 61115-A01-000 0452187 0450722 Aprilia Amico LX / Sport /GL /GE 50 de 1991 a 1998 Aprilia Area 51 50 de 1998 a 2000 Aprilia Gulliver LC 50 de 1994 a 1998 Aprilia Rally Air LC 50 de 1995 a 2003 Aprilia SR Air Esquire/Urban 50 de
单重/克	盒重96克			
单盒规格	77X55X50MM			
阿里链接				
参考链接				
最大电流				
插针数量				
保护套				
检测码	1372			
产品尺寸				
产品编号	1717			Polaris Trail Boss 330 2003-2013 Magnum 330 03-06 3087253, 3088209 POLARIS ATV TRAIL BOSS 330 2003-2013 TRAIL BOSS 330 INTL 2010-2012 MAGNUM 330 2X4 2003-2005 MAGNUM 330 2X4 HDS 2003 MAGNUM 330 4X4 2003-2006 Yamaha KRISS II 马来西亚款
单重/克	净重244克			
单盒规格				
阿里链接				
参考链接				
最大电流				
插针数量				
保护套				
检测码				
产品尺寸				
产品编号	3702			Honda TRX300 (1998-2000) Honda TRX300 FW Fourtrax (1998-2000) OEM 30410-HM5-A11 30410-HM5-S01 30400-HM5-506
单重/克	245克总重量197.3净重			
单盒规格				
阿里链接				
参考链接				
最大电流				
插针数量				
保护套				
检测码				
产品尺寸				
产品编号	3703			Honda TRX 350FE Rancher -- 2000-2005 Honda TRX 350FM Rancher -- 2000-2005 Honda TRX 350TE Rancher -- 2000-2005 Honda TRX 350TM Rancher -- 2000-2005 30410-HN5-671 30400-HN5-305 30410- HN4-671 30400-HN4-305 30410-HN4-670 30410-HN5-670 30405-HN5-303
单重/克	248总重202.5净重			
单盒规格				
阿里链接				
参考链接				
最大电流				
插针数量				
保护套				
检测码				
产品尺寸				

产品资料1		实物主图	接口图	适用范围
产品编号	13710			Honda NX560 1988-1989 Honda XR650L 1993-2015 HONDA 30410-MN9-000, 30410-MN9-790, 30410-MN9-791
产品单重	190克			
检测机码	37103899			
导线长度				
内盒尺寸	100X60X45MM			
外箱尺寸				
输出电压				
一箱只数				
铝壳尺寸				
安装孔距				
产品编号	3712			Yamaha Gas Golf Cart G9 1990-1994 Engine Ignitor 99999-02368
产品单重	净重150+盒子15克			
检测机码				
导线长度				
内盒尺寸	100*85*30 MM			
外箱尺寸				
输出电压				
一箱只数				
铝壳尺寸				
安装孔距				
产品编号	3712B			Yamaha Gas Golf Cart G9 1990-1994 Engine Ignitor 99999-02368
产品单重	净重160+盒子15克			
检测机码				
导线长度				
内盒尺寸	100*85*30 MM			
外箱尺寸				
输出电压				
一箱只数				
铝壳尺寸				
安装孔距				
产品编号	G5001.0		孔距: 90MM 	Suzuki - 33410-31311 Suzuki GS E / ES 750 1983 33410-31310 Suzuki GS E / ES 750 1983 33420-31310 Suzuki GS EF / EG / ES 1150 de 1984 a 1986 33410-31310 Suzuki GS EF / EG / ES 1150 de 1984 a 1986 33420-31310 Suzuki GS G / GL 650 de 1981 a 1983 33410-34210 Suzuki GS G 1100 de 1981 a 1984 33410-34210
单重/克	365g			
单盒规格	长*宽*高MM			
一箱只数	G50			
所属类别	高压包			
初级电阻	4			
次级电阻	13.8K			
安装孔距	90MM			
高压线长	35.5MM			
85119090.00 参考资料	10258			

13710

3712







3712B

5001.0

5001.0

产品资料1		实物主图	接口图	适用范围
产品编号	G5001.1	 <p style="text-align: right; color: red; font-weight: bold;">5001.1</p>	 <p style="text-align: center; color: red; font-weight: bold;">孔距：90MM</p> <p style="text-align: right; color: red; font-weight: bold;">5001.1</p>	适用于：410916900 410920100 21171-1019 YAMAHA ROAD STAR WARRIOR 1700 XV1700P 2002-2004 KAWASAKI KZ1000B LTD / KZ1000A 1977 1978 1979 KAWASAKI ZN1100 ZN1100B LTD 1984 1985 KAWASAKI KZ400 D D3 D4 1974 1975 1976 1977 KAWASAKI KZ1000 POLICE KZ1000P 2001 2002 2003 2004 2005
单重/克	380g			
单盒规格	长40*宽40*高28MM			
一箱只数	G50			
所属类别	高压包			
初级电阻	4			
次级电阻	13.8K			
安装孔距	90MM	 <p style="text-align: right; color: red; font-weight: bold;">5001.2</p>	 <p style="text-align: center; color: red; font-weight: bold;">孔距：102MM</p> <p style="text-align: right; color: red; font-weight: bold;">5001.2</p>	产品编号 5001.2 直流电感 适用于：30510-MM5-003 30510-KT7-013 30510-KT7-023 30510-MCC-003 30500-422-013 30510-333-013 30501-323-003 30501-300-003 30510-MM8-003 30510-KYJ-901 30500-422-003 Honda CA 160 Touring 1966-1969 Honda CA 175 Touring 1968-1970 Honda CB 1000 1994-1995 Honda CB 1000 2011-2012 Honda CB 1000 C - Custom 1983 Honda CB 1000 R 1994 Honda CB 1000 R 2011-2013 Honda CB 1100 2013 Honda CB 1100 ABS 2013
产品编号	5001.2			
单重/克	357g			
单盒规格	长40*宽40*高28MM			
一箱只数	G50只/18.5Kg			
所属类别	高压包			
初级电阻	3.6			
次级电阻	13.8K			
安装孔距	102MM	 <p style="text-align: right; color: red; font-weight: bold;">5001.3</p>	 <p style="text-align: center; color: red; font-weight: bold;">孔距：102MM</p> <p style="text-align: right; color: red; font-weight: bold;">5001.3</p>	适用于： Honda GL 1000 1975-1979
高压线长	35.5MM			
产品编号	G5001.3			
单重/克	358g			
单盒规格	长40*宽40*高28MM			
一箱只数	G50只/19.6Kg			
所属类别	高压包			
初级电阻	4			
次级电阻	13.8K			
安装孔距	102MM	 <p style="text-align: right; color: red; font-weight: bold;">5001.4</p>	 <p style="text-align: center; color: red; font-weight: bold;">孔距：102MM</p> <p style="text-align: right; color: red; font-weight: bold;">5001.4</p>	适用于： 420866605 410911800 410913500 410915000 Ski-doo Alpine 508 Carb F/C 1990 Ski-doo Alpine II 503 Carb F/C 1987-1988 Ski-doo Alpine II 503 Carb F/C 1990 Ski-doo Alpine II 503 Carb F/C 1993-1995 Ski-doo Escapade 503 Carb F/C 1987 Ski-doo Formula MX 467 Carb L/C 1987-
高压线长	0MM			
产品编号	G5001.4			
单重/克	358g			
单盒规格	长40*宽40*高28MM			
一箱只数	G50只/18.5Kg			
所属类别	高压包			
初级电阻	4			
次级电阻	13.8K			
安装孔距	102MM			
高压线长	0MM			

产品资料1		实物主图	接口图	适用范围
产品编号	G5001.5	 <p style="text-align: right; color: red; font-weight: bold;">5001.5</p>	<p style="color: red; font-weight: bold;">孔距: 90MM</p> <p style="text-align: right; color: red; font-weight: bold;">5001.5</p>	IGNITION COIL YAMAHA YFZ350 1997-2006 ATV NEW (Fits: Yamaha Banshee 350)
单重/克	3378g			
单盒规格	长40*宽40*高28MM			
一箱只数	G50只/18.5Kg			
所属类别	高压包			
初级电阻	4			
次级电阻	13.8K			
安装孔距	90MM			
高压线长	0MM			
产品编号	G5001.6	 <p style="text-align: right; color: red; font-weight: bold;">5001.6</p>	<p style="color: red; font-weight: bold;">孔距: 102MM</p> <p style="text-align: right; color: red; font-weight: bold;">5001.6</p>	SPI Ignition Coil Ski-Doo MXZ Skandic Replaces OEM #'s 512059564 & 410922935 2002 Ski-Doo MXZ 800 Rev 2002 Ski-Doo MXZ X 440 2002 Ski-Doo Skandic 600 WT L/C 2003 Ski-Doo MXZ 600HO Sport 2003 Ski-Doo MXZ 600HO X 2003 Ski-Doo MXZ X 440 2003 Ski-Doo MXZ 800 Sport 2003 Ski-Doo MXZ 800 X
单重/克	3378g			
单盒规格	长40*宽40*高28MM			
一箱只数	G50只/18.5Kg			
所属类别	高压包			
初级电阻	4			
次级电阻	13.8K			
安装孔距	102MM			
高压线长	0MM			
产品编号	G5001.7	 <p style="text-align: right; color: red; font-weight: bold;">5001.7</p>	<p style="color: red; font-weight: bold;">孔距: 102MM</p>	Caltric IGNITION COIL Fits SKIDOO FORMULA 500 Z LC 1998-2000 DOUBLE LINE
单重/克	3378g			
单盒规格	长40*宽40*高28MM			
一箱只数	G50只/18.5Kg			
所属类别	高压包			
初级电阻	4			
次级电阻	13.8K			
安装孔距	102MM			
高压线长	0MM			
产品编号	G5001.8	 <p style="text-align: right; color: red; font-weight: bold;">5001.8</p>	<p style="color: red; font-weight: bold;">孔距: 102MM</p>	278000383 278001130 JETSKI JET SKI JETBOAT JET BOAT SEA-DOO
单重/克	3378g			
单盒规格	长40*宽40*高28MM			
一箱只数	G50只/18.5Kg			
所属类别	高压包			
初级电阻	1			
次级电阻	12.5K			
安装孔距	102MM			
高压线长	82和102CM			









产品资料1		实物主图	接口图	适用范围
产品编号	G5001.9	 <p>G5001.9</p>	<p>孔距：102MM</p> 	CB160/65-69/CL160/CL175/CL200/30500-216-405 30500-216-000, 30400-306-673, 30400-306-672
单重/克	380g			
单盒规格	长40*宽40*高28MM			
一箱只数	G50只/18.5Kg			
所属类别	高压包			
初级电阻	4			
次级电阻	13.8K			
安装孔距	102MM			
高压线长	0MM			
产品编号	G5001.8A	 <p>5001.8A</p>	<p>孔距：102MM</p>	278000383 278001130 JETSKI JET SKI JETBOAT JET BOAT SEA-DOO
单重/克	3378g			
单盒规格	长40*宽40*高28MM			
一箱只数	G50只/18.5Kg			
所属类别	高压包			
初级电阻	2			
次级电阻	12.5K			
安装孔距	102MM			
高压线长	82和102CM			
产品编号	G5001.9	 <p>G5001.9</p>	<p>孔距：102MM</p> 	适用于： Honda CB160 CL160 CL175 CL200
单重/克	358g			
单盒规格	长40*宽40*高28MM			
一箱只数	50只/19.6Kg			
所属类别	高压包			
初级电阻	4			
次级电阻	14.1K			
安装孔距	102MM			
高压线长	204MM			
产品编号	G5001.10	 <p>G5001.10</p>	<p>孔距：102MM 用5001.8改</p>	适用于： Honda CB250 400 450 CM400 450 Nighthawk 1979-83 30530-413-003 30530-447-003 初级1.4欧
单重/克	358g			
单盒规格	长40*宽40*高28MM			
一箱只数	50只/19.6Kg			
所属类别	高压包			
初级电阻	1.4			
次级电阻	14.1K			
安装孔距	102MM			
高压线长	204MM			





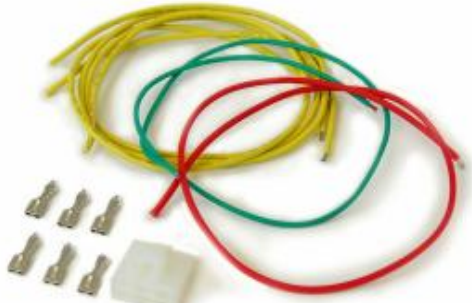

产品资料1		实物主图	接口图	适用范围
产品编号	G5002.0	 <p style="text-align: right; color: red; font-weight: bold;">5002.0</p>	<p style="color: red; font-weight: bold;">孔距: 102MM</p>  <p style="text-align: right; color: red; font-weight: bold;">5002.0</p>	10256 Honda CB 650 de 1979 a 1981 30500-422-003 Honda CB 700 de 1984 a 1986 30506-MA6-003 Honda CB 650 de 1983 a 1985 30506-MA6-003 Honda CB 1000 1983 30500-422-013 Honda CB 900 de 1980 a 1982 30500-422-013 Honda CB 750 de 1979 a 1983 30500-
单重/克	298g			
单盒规格	长40*宽40*高28MM			
一箱只数	G50只/19.8Kg			
所属类别	高压包			
初级电阻	2.5			
次级电阻	14.5K			
安装孔距	102MM			
高压线长	0MM			
产品编号	G5002.1	 <p style="text-align: right; color: red; font-weight: bold;">5002.1</p>	<p style="color: red; font-weight: bold;">孔距: 102MM</p>  <p style="text-align: right; color: red; font-weight: bold;">5002.1</p>	10256 Honda CB 650 de 1979 a 1981 30500-422-003 Honda CB 700 de 1984 a 1986 30506-MA6-003 Honda CB 650 de 1983 a 1985 30506-MA6-003 Honda CB 1000 1983 30500-422-013 Honda CB 900 de 1980 a 1982 30500-422-013 Honda CB 750 de 1979 a 1983 30500-
单重/克	盒重 410.3克			
单盒规格	长40*宽40*高28MM			
一箱只数	G50			
所属类别	高压包			
初级电阻	2.5			
次级电阻	14.5K			
安装孔距	102MM			
高压线长	58MM			
参考资料	12056			
产品编号	G5002.2	 <p style="text-align: right; color: red; font-weight: bold;">5002.2</p>	<p style="color: red; font-weight: bold;">孔距: 102MM</p>	Honda CB 650 de 1979 a 1981 30500-422-003 Honda CB 700 de 1984 a 1986 30506-MA6-003 Honda CB 650 de 1983 a 1985 30506-MA6-003 Honda CB 1000 1983 30500-422-013 Honda CB 900 de 1980 a 1982 30500-422-013 Honda CB 750 de 1979 a 1983 30500-422-013
单重/克	513克			
单盒规格	长40*宽40*高28MM			
一箱只数	G50			
所属类别	高压包			
初级电阻	1.5			
次级电阻	14.5K			
安装孔距	102MM			
高压线长	58MM			
产品编号	G5004.0	 <p style="text-align: right; color: red; font-weight: bold;">5004.0</p>	 <p style="text-align: right; color: red; font-weight: bold;">5004.0</p>	适用于: OUTBOARD IGNITION COIL FOR YAMAHA 680-85570-09-00, 6E7-85570-19-00, 6E7-85570-10-0
单重/克	70克			
单盒规格	长*宽*高MM			
一箱只数				
所属类别				
初级电阻				
次级电阻				
安装孔距	60MM			
高压线长				

产品资料1		实物主图	接口图	适用范围
产品编号	G5004.1	 <p style="text-align: right;">5004.1</p>	<p>孔距: 61.5MM</p>  <p style="text-align: right;">5004.1</p>	适用于: 插头线长10CM, 安装安装孔距离60MM 高压线长 45CM OUTBOARD IGNITION COIL FOR YAMAHA 680-85570-09-00, 6E7-85570-19-00, 6E7-85570-10-0 POLARIS SPORTSMAN 700 2004 2005 2006 Polaris New OEM ATV Ignition Coil Wire & Cap Sportsman 600 700 MV7 Engine Spark
单重/克	81克			
单盒规格	长*宽*高MM			
一箱只数				
所属类别				
初级电阻				
次级电阻				
安装孔距	60MM			
高压线长	45CM			
产品编号	G5007.1	 <p style="text-align: right;">5007.1</p>	 <p style="text-align: right;">5007.1</p>	适用于: 21121-1160 21121-1198 Kawasaki KLF 220 Bayou 1988-2002 Kawasaki KLF 250 Bayou 2003-2011 Kawasaki KLF 400 Bayou 4x4 1993-1999 Kawasaki KLF 400 Bayou 4x4 Euro 1995-1999 Kawasaki KVF 300 Prairie 2x4 1999-2002 Kawasaki KVF 300 Prairie 4x4 1999-2002
单重/克	净重 130克, 盒装重 147.5克			
单盒规格	长*宽*高MM			
一箱只数				
所属类别				
初级电阻				
次级电阻				
产品编号	G5009.1	 <p style="text-align: right;">5009.1</p>	 <p style="text-align: right;">5009.1</p>	适用于: Dynatek Coils Coil 3 ohm Dual output Ignition DC1-1 Honda cb 500 550 750 gl1000 直流高压包
单重/克	380克配件另有38克			
单盒规格	长*宽*高MM			
一箱只数				
所属类别				
初级电阻	5			
次级电阻	17.7K			
成码	457654			
产品编号	G5010.1	 <p style="text-align: right;">5010.1</p>	 <p style="text-align: right;">5010.1</p>	适用于: KOHLER K482, K532, K582, KT17, KT19 277375 277375S 271688 271871
单重/克	538克			
单盒规格	长*宽*高MM			
一箱只数				
所属类别				
初级电阻				
次级电阻				
成码	605315			

产品资料1		实物主图	接口图	适用范围
产品编号	5011.1	 <p style="text-align: center; color: red; font-weight: bold;">5011.1</p>	 <p style="text-align: center; color: red; font-weight: bold;">5011.1</p>	适用于： Lumix GC Ignition Coil For Johnson Evinrude 4-300HP 582508 18-5179 183- 2508 72010 5179
单重/克	盒重222克 净重218克			
单盒规格	长78*宽45 *高60 MM			
一箱只数				
所属类别				
初级电阻				
次级电阻				
成码	346755			
产品编号	5014.1			
单重/克	盒重230克,			
单盒规格	长110*宽66*高56 MM			
一箱只数				
所属类别				
初级电阻				
次级电阻				
成码	354443			
产品编号	5014.2	 <p style="text-align: center; color: red; font-weight: bold;">5014.2</p>		Kawasaki 21171-0743 21171-0711 21171-0738 21171-7036 21171-7041 21171-7042 21171-7047 21171-7052 21171-0718
单重/克	盒重236克,			
单盒规格	长110*宽66*高56 MM			
一箱只数				
所属类别				
初级电阻				
次级电阻				
成码	434312			
产品编号	5C100			
单重/克	265克			
单盒规格				
一箱只数				
所属类别				
初级电阻				
次级电阻				
检测成品码	38998365			

产品资料1		实物主图	接口图	适用范围
产品编号	5C103			Club Car Ignition Coil EZ/G0点火线圈/OEM/26652-G01替换EPIGC103点火线圈
单重/克	270克			
单盒规格				
一箱只数				
所属类别				
初级电阻				
次级电阻				
检测成品码	55980022	5C103		
产品编号	CT-2001.1D			R2001.1 R2001.2 R2001A.1 R2001A.2 R2001A.4 R2001B.1 R2001C.1R2056.18
产品单重	34克			
检测机码				
导线长度				
内盒尺寸				
外箱尺寸				
输出电压				
一箱只数				
铝壳尺寸				
安装孔距				
产品编号	CT-R2025.19			R2025.19
产品单重	34克			
检测机码				
导线长度				
内盒尺寸				
外箱尺寸				
输出电压				
一箱只数				
铝壳尺寸				
安装孔距				
产品编号	CT-2001.1DB			R2001.1 R2001.2 R2001A.1 R2001A.2 R2001A.4 R2001B.1 R2001C.1R2056.18
产品单重	54克			
检测机码				
导线长度				
内盒尺寸				
外箱尺寸				
输出电压				
一箱只数				
铝壳尺寸				
安装孔距				
		CT-2001.1DB		

产品资料1		实物主图	接口图	适用范围
产品编号	CT-R2005.0-D			R2002.3 R2003.2 R2005.0 R2010.0 R2011.0 R2015.11 R2027.10 R2056.17
产品单重	30克			
检测机码				
导线长度				
内盒尺寸				
外箱尺寸				
输出电压				
一箱只数	50			
铝壳尺寸				
安装孔距				
		CT-R2005.0-D		
产品编号	R2005.0-DX			Voor Kawasaki Z1000SX ZX1000 Z250 Z300 Z750 Z800 Z1000 Voor Kawasaki VN900 Vulcan 900 06-12 Voor Kawasaki VERSYS 650 KLE650 07-16 Voor Kawasaki ER-6 ER6F ER6N ER4N/F Voor Kawasaki EX300 EX250 Ninja 300/250 Voor Honda TRX400 TRX400 FA Rancher ATV 2004-2007 Voor Honda TRX450 TRX450 Foreman ATV 2005.1-D 对插
产品单重	克			
检测机码				
导线长度				
内盒尺寸				
外箱尺寸				
输出电压				
一箱只数	50			
铝壳尺寸				
安装孔距				
		R2005.0-DX		
产品编号	R2005.1-D			2005.1-D 对插
产品单重	20克			
检测机码				
导线长度				
内盒尺寸				
外箱尺寸	49.5*25.5*30.5CM			
输出电压	14.5±0.5V			
一箱只数	50			
铝壳尺寸				
安装孔距				
		R2005.1-D		
产品编号	R2005.1.2-D			2005.1.2-D 对插事线
产品单重	50克			
检测机码				
导线长度	40CM			
内盒尺寸	100*85*30MM			
外箱尺寸	49.5*25.5*30.5CM			
输出电压	14.5±0.5V			
一箱只数	50			
铝壳尺寸				
安装孔距				
		R2005.1.2-D		

产品资料1		实物主图	接口图	适用范围
产品编号	R2009.0-DX			R2009.0 R2009.2 R2009.2 R2009.4 R2009.5
产品单重	27克			
检测机码				
导线长度	15CM			
内盒尺寸	100*85*30MM			
外箱尺寸	49.5*25.5*30.5CM			
输出电压	14.5±0.5V			
一箱只数	50			
铝壳尺寸				
安装孔距				
产品编号	CT-R2009.6-21			2009.6 对插
产品单重	25克			
检测机码				
导线长度				
内盒尺寸	100*85*30MM			
外箱尺寸	49.5*25.5*30.5CM			
输出电压	14.5±0.5V			
一箱只数	50			
铝壳尺寸				
安装孔距				
产品编号	3004.0-DX			Suzuki Starter Relay solenoid CONNECTOR PLUG TL1000 GSXR Hayabusa SV650 SV1000 可配继电器 J3004系列的
产品单重	30克			
检测机码				
导线长度	10CM			
导线直径	2.8MM			
内盒尺寸	塑料袋子			
外箱尺寸				
一箱只数				
铝壳尺寸				
安装孔距				
红线 黄线 蓝线		3004.0-DX		
产品编号	3004.1H-DX			Fit for Suzuki RF600 RF 600R RF900 1994-1996 Fit for Suzuki GSX1100 1988-1993 Fit for Yamaha Bruin 250 YFM25 ATV QUAD 4 WHEELER 2006 Fit for Yamaha YFM250 Bear Tracker 1999-2004 Fit for Yamaha YFM250 Big Bear 2007-2009 Fit for Yamaha YFM250 Bruin 2005-2006
产品单重	30克			
检测机码				
导线长度	10CM			
导线直径	2.8MM			
内盒尺寸	塑料袋子			
外箱尺寸				
一箱只数				
铝壳尺寸				
安装孔距				
红线 黄线 蓝线		3004.1H-DX		

产品资料1		实物主图	接口图	适用范围
产品编号	3005.0-DX			Suzuki Starter Relay solenoid CONNECTOR PLUG TL1000 GSXR Hayabusa SV650 SV1000 可配继电器 J3005.0 J3005.1 J3005.2 J3005.0H
产品单重	30克			
检测机码				
导线长度	15CM			
导线直径	2.8MM			
内盒尺寸	塑料袋子			
外箱尺寸				
一箱只数				
红线 红白线黄线 黄红线				
3005.0-DX				
产品编号	J3006.0.2			J3006.0 J3006.1
产品单重	16克			
检测机码				
导线长度	13CM			
导线直径	2.8MM			
内盒尺寸	塑料袋子			
外箱尺寸				
一箱只数				
红线 红白线黄线 黄红线				
J3006.0.2				
产品编号	3006.0-D			Honda CB starter relay/solenoid plug connector 1000 1100 600 900 400 450 650 750
产品单重	克			
检测机码				
导线长度				
导线直径				
内盒尺寸	塑料袋子			
外箱尺寸				
一箱只数				
3006.0-D				
产品编号	R2001.1-R2002.0			2001.1转2002.0 Set Connectors Suzuki Gsxr 750200620072008200 2010201120122013
产品单重	克			
检测机码				
导线长度	25CM			
导线直径	2.8MM			
内盒尺寸	塑料袋子			
外箱尺寸				
一箱只数				
R2001.1-R2002.0				





产品资料1		实物主图	接口图	适用范围
产品编号	R2001.1-R2003.0			2001.1转2003.0
产品单重	克			
检测机码				
导线长度	25CM			
导线直径	2.8MM			
内盒尺寸	塑料袋子			
外箱尺寸				
一箱只数				
产品编号	R2001.1-R2004.6			2001.1转2004.6
产品单重	克			
检测机码				
导线长度	25CM			
导线直径	2.8MM 1.5平方			
内盒尺寸	塑料袋子			
外箱尺寸				
一箱只数				
产品编号	R2001F.2D			Conversion Harness For Polaris Recall Ranger/RZR 570 900 1000 General 1000 ACE 325 570 2012-2018 OEM Repl.# 2206367/4013904 / 4014029/4014856 / 4015229/4016868
产品单重				
检测程序				
导线长度	2m²X60 CM			
内盒尺寸				
外箱尺寸	49.5*25.5*30.5CM			
输出电压				
一箱只数				
产品编号	R2001F.3D			Conversion Harness For Polaris Recall Ranger 500 570 900 1000 RZR 570 900 1000 General 1000 ACE 325 570 2012-2018 OEM Repl.# 2206367/4013904 / 4014029/4014856 / 4015229/4016868
产品单重				
检测程序				
导线长度	2m²X (30CM)			
内盒尺寸				
外箱尺寸	49.5*25.5*30.5CM			
输出电压				
一箱只数				

R2001.1-R2004.6

R2001F.2D

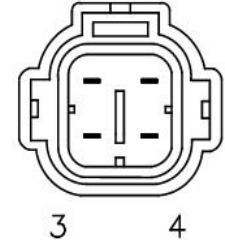
R2001F.3D

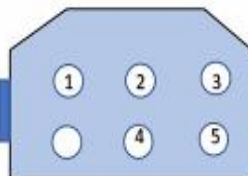
产品资料1		实物主图	接口图	适用范围
产品编号	R2001F. 3DC			Conversion Harness For Polaris Recall Ranger 500 570 900 1000 RZR 570 900 1000 General 1000 ACE 325 570 2012-2018 OEM Repl.# 2206367/4013904 / 4014029/4014856 / 4015229/4016868
产品单重	227克总重			
检测程序				
导线长度	2m²X (100CM)			
内盒尺寸				
外箱尺寸	49.5*25.5*30.5CM			
输出电压				
一箱只数				
铝壳尺寸				Voltage Regulator Rectifier Connector Kit For Ducati Monster 900 / S4R 2003 2004
产品编号	CT4+3			
产品单重	35克			
检测机码				
导线长度				
导线直径				
内盒尺寸	塑料袋子			
外箱尺寸				
一箱只数				4 PINS HIGH POWER PGO GMAX REGULATOR RECTIFIER CONNECTORS 1 kit 14 AWG
产品编号	2012A. 6-CT-4+4			
产品单重	克			
检测机码				
导线长度	25CM			
导线直径	2.8MM			
内盒尺寸	塑料袋子			
外箱尺寸				
一箱只数				Regulator Rectifier Connector Kit For Honda GL 1000 1100 1200 Goldwing 1977 1978
产品编号	CT-R2002. 13			
产品单重	克			
检测机码				
导线长度	26CM			
导线直径	2.9MM			
内盒尺寸	塑料袋子			
外箱尺寸				
一箱只数				

产品资料1		实物主图	接口图	适用范围
产品编号	CT-SJ-XS001	<p>1平方线 线长20CM</p>  <p>CT-SJ-XS001</p>	 <p>1 2 3 4</p> <p>1黑白线 2绿线 3黑线 4红线</p>	四季赛车定做 电门锁线长20CM
产品单重	克			
检测机码				
导线长度	20CM			
导线直径	2.8MM 1平方			
内盒尺寸	塑料袋子			
外箱尺寸		<p>1平方线 线长25CM</p>  <p>CT-SJ-XS002</p>	 <p>1 2 3 4 5</p> <p>1黑红线 2棕线 3红线 4黑白线 5黑线</p>	四季赛车 定做 电门锁线长25CM
产品编号	XS002			
产品单重	克			
检测机码				
导线长度	25CM			
导线直径	2.8MM 1平方			
内盒尺寸	塑料袋子			
外箱尺寸		<p>CT-R2004.3-21</p> 		
产品编号	CT-R2004.3-21			
产品单重	克			
检测机码				
导线长度	25CM			
导线直径	2.8MM 1平方			
内盒尺寸	塑料袋子			
外箱尺寸		 <p>CT+XS-R2012.21</p>		
产品编号	CT+XS-R2012.21			
产品单重	克			
检测机码				
导线长度	35CM			
导线直径	黄线1.5 其他1			
内盒尺寸	塑料袋子			
外箱尺寸				
一箱只数				

产品资料1		实物主图	接口图	适用范围
产品编号	CT444	 <p>CT444</p>		
产品单重	克			
检测机码				
导线长度	35CM			
导线直径	黄线1.5 其他1			
内盒尺寸	塑料袋子			
外箱尺寸				
一箱只数				
产品编号	CT445	 <p>CT445</p>		
产品单重	克			
检测机码				
导线长度	35CM			
导线直径	黄线1.5 其他1			
内盒尺寸	塑料袋子			
外箱尺寸				
一箱只数				
产品编号	CT446	 <p>CT446</p>		
产品单重	克			
检测机码				
导线长度	35CM			
导线直径	黄线1.5 其他1			
内盒尺寸	塑料袋子			
外箱尺寸				
一箱只数				
产品编号	CT447	 <p>CT447</p>		
产品单重	克			
检测机码				
导线长度	35CM			
导线直径	黄线1.5 其他1			
内盒尺寸	塑料袋子			
外箱尺寸				
一箱只数				

产品资料1		实物主图	接口图	适用范围
产品编号	CT+XS-R2004.6			
产品单重	克			
检测机码				
导线长度	35CM			
导线直径	黄线1.5 其他1			
内盒尺寸	塑料袋子			
外箱尺寸				
一箱只数		CT+XS-R2004.6		
产品编号	CT+XS-R2004.12			
产品单重	克			
检测机码				
导线长度	35CM			
导线直径	黄线1.5 其他1			
内盒尺寸	塑料袋子			
外箱尺寸				
一箱只数		CT+XS-R2004.12		
产品编号	CT-R2012.21			
产品单重	克			
检测机码				
导线长度	35CM			
导线直径	黄线1.5 其他1			
内盒尺寸	塑料袋子			
外箱尺寸				
一箱只数		CT-R2012.21		
产品编号	CT-R2007.0-D			
产品单重	克			
检测机码				
导线长度				
导线直径				
内盒尺寸	塑料袋子			
外箱尺寸				
一箱只数		CT-R2007.0-D		