

CHANGZHOU LINHUI ELECTRONICS CO., LTD
CHANGZHOU XINLIU INTERNATIONAL TRADE CO., LTD
Add: Miaoqiao, Wujin, Changzhou, Jiangsu Province, China
Tel: 0086-519-86461385 0086-519-86470931
Fax: 0086-519-86462385
Website: www.chinalinhui.com
Email: jsczlinhui@126.com
huahui158@vip.sina.com
Post Code: 213167

CHANGZHOU LINHUI ELECTRONICS CO., LTD
CHANGZHOU XINLIU INTERNATIONAL TRADE CO., LTD

COMPANY INTRODUCTION

CHANGZHOU XIULIN INTERNATIONAL TRADE Co., LTD (CHANGZHOU LINHUI ELECTRONICS CO., LTD) is an import/export/manufacturer company established in 2004. (CHANGZHOU LINHUI was established in 2000). Our company locates in Changzhou, Jiangsu province, which is a very beautiful city with a long history and convenient transportation: one hour to Shanghai or Nanjing by high speed train.

CHANGZHOU LINHUI ELECTRONICS CO., LTD is dealing in speaker, power, LAN, HDMI, Alarm, coaxial and A/V cables, as well as amplifier wiring kits and connectors. Our products have been exported to Asia, Middle East and Africa, America , Europe .

CHANGZHOU XIULIN INTERNATIONAL TRADE Co., LTD has 5 subsidiary companies: Changzhou Linhui Electronics Co. Ltd, Changzhou Anxin Logistic Co. Ltd, Changzhou Shengyue Model Co., Ltd, Changzhou Henghe Machinery Co., Ltd and Changzhou Chang lin textile Co., Ltd. support. Our objective is to develop long-term relationships with our clients. To do so, we could provide to all customers the best cost-effective production, convent storage and logistic service. We are a motivated and hardworking team full with energy, warmth, technology, experience and good management. We also develop a network of quality-conscious, cost-effective partner manufacturers around China. Our concept is to provide satisfying service of international trade: product development, quality control, financial support, warehouse and logistics which provide our existing clients new products, advanced designs, and patented innovations so that they can stay on the top of their markets.

We are in honor to be your reliable business partner and purchase office in China.

Content

PREMIUM METALLIC CABLE	1-6
HDMI CABLE	7-15
DVI CABLE	16
VGA CABLE	17-18
AUX CABLE	19
CELLPHONE CABLE	20-21
CAR CHARGER/HOME CHARGER	22-23
HDMI ADAPTOR	24-25
DVI ADAPTOR	26
VGA ADAPTOR	27
HDMI SPLITTER	28-29
HDMI REPEATER/EXTENDER/GAME ADAPTOR	30
VGA SPLITTER/NETWORKING DISPLAY ADAPTOR	31
CAT 5E/CAT 6 PATCH CORD CABLE	32
LAN CABLE	33-36
SPEAKER CABLE	37
USB CABLE	38-39
USB ADAPTOR	40
DVI/DB/VGA ADAPTOR	41-42
POWER CABLE	43-44
POWER ADAPTOR	45-48
AUDIO & VIDEO CABLE	49-58
TELEPHONE CABLE	59
VIDEO BALUN	60
MICROPHONE CABLE	61
AUDIO & VIDEO & TV CONNECTOR	62-94



LH02-1001

HDMI PLUG TO HDMI PLUG,
ROUND CABLE
METAL PLUG

COLORS



- 3D READY
- HDMI ETHERNET CHANNEL
- AUDIO RETURN CHANNEL
- 4KX2K VIDEO SUPPORT
- DUAL-STREAM 1080P
- PERFECT FOR HDTV,GAMING
BLU-RAY PLAYER



LH02-1002

HDMI PLUG TO MINI HDMI PLUG,
ROUND CABLE
METAL PLUG

COLORS



- 3D READY
- HDMI ETHERNET CHANNEL
- AUDIO RETURN CHANNEL
- 4KX2K VIDEO SUPPORT
- DUAL-STREAM 1080P
- PERFECT FOR CAMERA OR
SMARTPHONE TO HDTV



LH02-1003

HDMI PLUG TO MICRO HDMI PLUG,
ROUND CABLE
METAL PLUG

COLORS



- 3D READY
- HDMI ETHERNET CHANNEL
- AUDIO RETURN CHANNEL
- 4KX2K VIDEO SUPPORT
- DUAL-STREAM 1080P
- PERFECT FOR CAMERA OR
SMARTPHONE TO HDTV



LH02-1004

HDMI PLUG TO HDMI PLUG,
ROUND CABLE
METAL PLUG

- 3D READY
- HDMI ETHERNET CHANNEL
- AUDIO RETURN CHANNEL
- 4KX2K VIDEO SUPPORT
- DUAL-STREAM 1080P
- PERFECT FOR HDTV,GAMING,BLU-
RAY PLAYER



LH02-1005

3.5MM STEREO PLUG TO PLUG
AUDIO CABLE OD:3.0MM
METAL PLUG

- 3.5MM MALE TO MALE AUDIO CABLE
- 24K GOLD PLATED CONNECTOR
- PERFECT FOR MP3, MEDIA PLAYER, IPHONE, IPOD



LH02-1006

3.5MM STEREO PLUG TO 2
RCA PLUG AUDIO CABLE
METAL PLUG

- 3.5MM MALE TO 2 RCA MALE AUDIO CABLE
- 24K GOLD PLATED CONNECTOR
- PERFECT FOR MEDIA PLAYER TO AMPLIFIER OR SPEAKER

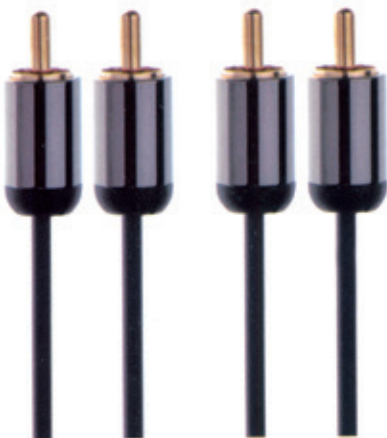

LH02-1007

2 RCA PLUG TO 2 RCA PLUG
AUDIO CABLE
METAL PLUG

- 2 RCA PLUG TO 2 RCA PLUG
- 24K GOLD PLATED CONNECTOR
- PERFECT FOR HOME THEATER, SET-TOP BOX, LCD AND PROJECTOR

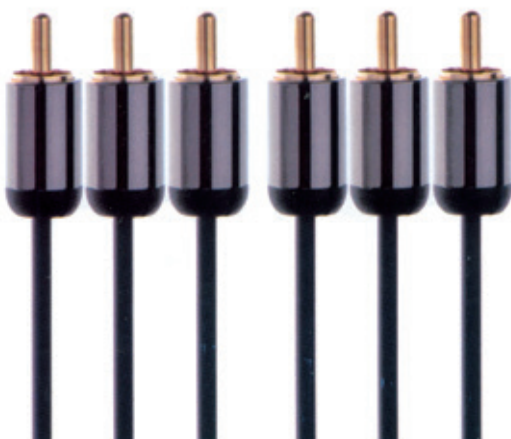

LH02-1008

3 RCA PLUG TO 3 RCA PLUG
AV CABLE
METAL PLUG

- 3 RCA PLUG TO 3 RCA PLUG
- 24K GOLD PLATED CONNECTOR
- PERFECT FOR HDTVS, DVD PLAYER AV RECEIVER

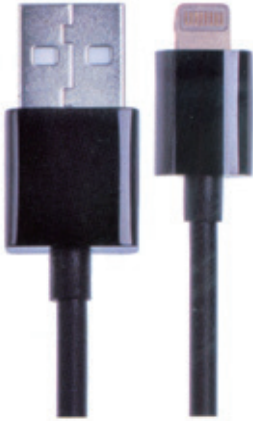

LH02-1009

USB AM TO LIGHTNING 8P
CABLE,METAL PLUG

- LIGHTNING 8P TO USB AM CABLE
- NICKEL PLATED CONNECTOR
- SYNC DATA AND CHARGING



LH02-1010

USB AM TO MICRO 5P
CABLE,METAL PLUG

- MICRO USB 5P TO USB AM CABLE
- NICKEL PLATED CONNECTOR
- SYNC DATA AND CHARGING



LH02-1011

AUDIO OPTICAL FIBER CABLE
METAL PLUG

- TOSLINK PLUG TO TOSLINK PLUG
- GOLD PLATED CONNECTOR
- PERFECT FOR MD,DVD,CD AND PC
SOUND CARDS



LH02-1012

3.5MM STEREO PLUG TO PLUG
AUDIO CABLE OD:3.0MM
METAL PLUG

- 3.5MM MALE TO MALE AUDIO CABLE
- 24K GOLD PLATED CONNECTOR
- PERFECT FOR MP3, MEDIA PLAYER, IPHONE, IPOD

COLORS



LH02-1013

3.5MM STEREO PLUG TO 2
RCA PLUG AUDIO CABLE
METAL PLUG

- 3.5MM MALE TO 2 RCA MALE AUDIO CABLE
- 24K GOLD PLATED CONNECTOR
- PERFECT FOR MEDIA PLAYER TO AMPLIFIER OR SPEAKER

COLORS



LH02-1014

2 RCA PLUG TO 2 RCA PLUG
AUDIO CABLE
METAL PLUG

- 2 RCA PLUG TO 2 RCA PLUG
- 24K GOLD PLATED CONNECTOR
- PERFECT FOR HOME THEATER, SET-TOP BOX, LCD AND PROJECTOR

COLORS



LH02-1015

3 RCA PLUG TO 3 RCA PLUG
AV CABLE
METAL PLUG

- 3 RCA PLUG TO 3 RCA PLUG
- 24K GOLD PLATED CONNECTOR
- PERFECT FOR HDTVS, DVD PLAYER, AV RECEIVER

COLORS





LH02-1016

HDMI PLUG TO HDMI PLUG,
ROUND CABLE
METAL PLUG

- 3D READY
- HDMI ETHERNET CHANNEL
- AUDIO RETURN CHANNEL
- 4KX2K VIDEO SUPPORT
- DUAL-STREAM 1080P
- PERFECT FOR HDTV,GAMING,
BLU-RAY PLAYER

COLORS



LH02-1017

USB AM TO LIGHTNING 8P
CABLE,METAL PLUG

- LIGHTNING 8P TO USB AM CABLE
- NICKEL PLATED CONNECTOR
- SYNC DATA AND CHARGING

COLORS



LH02-1018

USB AM TO MICRO 5P
CABLE,METAL PLUG

- MICRO USB 5P TO USB AM CABLE
- NICKEL PLATED CONNECTOR
- SYNC DATA AND CHARGING

COLORS



LH02-1019

USB AM TO IPHONE 30P
CABLE,METAL PLUG

- IPHONE 30P TO USB AM CABLE
- NICKEL PLATED CONNECTOR
- SYNC DATA AND CHARGING

COLORS





LH02-1020

USB AM TO 3.0 MICRO CABLE,
METAL PLUG

- USB 3.0 MICRO TO USB AM CABLE
- NICKEL PLATED CONNECTOR
- FIT FOR SAMSUNG GALAXY NOTE 3 CHARGING

COLORS



LH02-1021

HDMI PLUG TO USB AM AND
MICRO 11P MHL CABLE
METAL PLUG

- MHL TO HDMI CABLE MOBILE
TO TV CONNECTER CABLE
- FOR SAMSUNG GALAXY S5/S4/S3/S2 ETC



LH02-1022

AUDIO OPTICAL FIBER CABLE
METAL PLUG

- TOSLINK PLUG TO TOSLINK PLUG
- PERFECT FOR MD,DVD,CD AND PC
SOUND CARDS

HDMI 1.4 CABLE

CONSTRUCTION

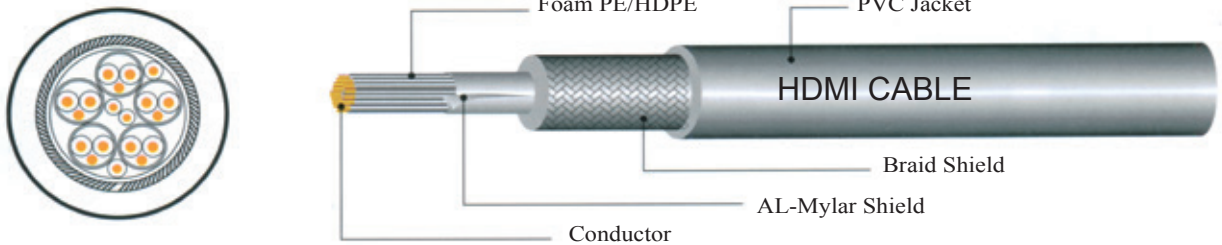

DESCRIPTION

- RATED TEMPERATURE: 80°C
- RATED VOLTAGE: 30V
- REFERENCE STANDARD : HIGH-DEFINITION MULTIMEDIA INTERFACE SPECIFICATION VERSION 1.4
- STRANDED TINNED COPPER CONDUCTOR , 32-22AWG
- COLOR-CODED FOAM PE OR PE INSULATION
- OVER 85% COVERAGE TINNED COPPER OR COPPER ALLOY BRAID SHIELD
- LEAD FREE PVC JACKET

ELECTRICAL CHARACTERISTIC

- DIFFERENTIAL IMPEDANCE (20°C): 100 ±10Ω
- DIFFERENTIAL DELAY ≤ 4.50NS/m
- PROPAGATION DELAY SKEW:
WITHIN A PAIR: ≤ 111 PS/M
BETWEEN PAIRS: ≤ 1.78 NS/M
- FAR END CROSS-TALK: ≤ -20DB, 1-5100MHZ

NEW FEATURES HDMI 1.4

- HDMI Ethernet Channel
- Audio Return Channel
- 3D Over HDMI
- 4K x 2K Resolution Support
- Expanded Support For Color Spaces
- Micro HDMI Connector
- Automotive Connection System

HDMI 2.0 CABLE

CONSTRUCTION

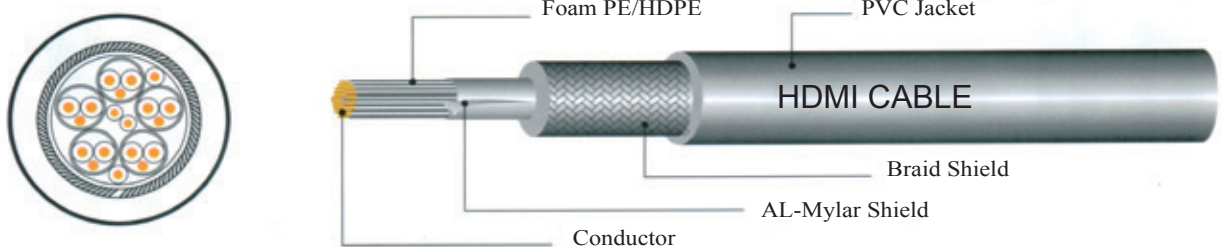

DESCRIPTION

- RATED TEMPERATURE: 80°C
- RATED VOLTAGE: 30V
- REFERENCE STANDARD : HIGH-DEFINITION MULTIMEDIA INTERFACE SPECIFICATION VERSION 1.4
- STRANDED TINNED COPPER CONDUCTOR , 32-22AWG
- COLOR-CODED FOAM PE OR PE INSULATION
- OVER 85% COVERAGE TINNED COPPER OR COPPER ALLOY BRAID SHIELD
- LEAD FREE PVC JACKET

ELECTRICAL CHARACTERISTIC

- DIFFERENTIAL IMPEDANCE (20°C): 100 ±10Ω
- DIFFERENTIAL DELAY ≤ 4.50NS/M
- PROPAGATION DELAY SKEW:
WITHIN A PAIR: ≤ 111 PS/M
BETWEEN PAIRS: ≤ 1.78 NS/M
- FAR END CROSS-TALK: ≤ -20DB, 1-5100MHZ

NEW FEATURES HDMI 2.0

- Up to 32 audio channels
- 4K x 2K Resolution Support, 2160p
- Up to 1536kHz audio sample frequency
- Simultaneous delivery of multi-stream audio to multiple users (up to 4)
- Support for the wide angle theatrical 21:9 video aspect ratio
- Dynamic synchronization of video and audio streams

ULTRA SLIM HDMI CABLE

LH02-1023

ULTRA SLIM HDMI PLUG
TO HDMI PLUG
METAL PLUG
ROUND CABLE



LH02-1024

ULTRA SLIM HDMI PLUG TO
MINI HDMI PLUG
METAL PLUG
ROUND CABLE



LH02-1025

ULTRA SLIM HDMI PLUG TO
MICRO HDMI PLUG
METAL PLUG
ROUND CABLE



LH02-1026

ULTRA SLIM HDMI PLUG TO
HDMI PLUG
ROUND CABLE



LH02-1027

ULTRA SLIM HDMI PLUG TO
MINI HDMI PLUG
ROUND CABLE



LH02-1028

ULTRA SLIM
HDMI PLUG TO MICRO HDMI PLUG
ROUND CABLE

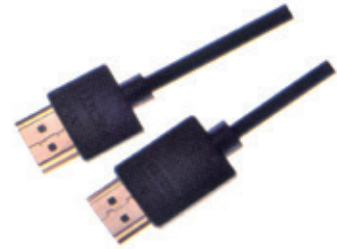

LH02-1029

ULTRA SLIM HDMI PLUG TO HDMI
PLUG.ABS PLUG, ROUND CABLE



LH02-1030

ULTRA SLIM HDMI PLUG TO MINI HDMI
PLUG.ABS PLUG, ROUND CABLE



LH02-1031

ULTRA SLIM HDMI PLUG TO MICRO
HDMI PLUG.ABS PLUG, ROUND CABLE



LH02-1032

ULTRA SLIM HDMI PLUG TO
HDMI PLUG, ABS PLUG
ROUND CABLE



LH02-1033

ULTRA SLIM HDMI PLUG TO
HDMI PLUG, ABS PLUG
ROUND CABLE



LH02-1034

ACTIVE ULTRA SLIM
HDMI PLUG TO
HDMI PLUG.ABS PLUG
ROUND CABLE



Construction



HDMI 1.4 & 2.0
 HDMI Ethernet Channel
 Audio Return Channel
 3D Support
 4K x 2K Support
 More Color Spaces
 New Connectors



LH02-1035

Gauge	UP to length	Specification
30AWG	5 meters	O.D.: 6.0mm;with/without ferrite
28AWG	10 meters	O.D.: 7.3mm;with/without ferrite
26AWG	15 meters	O.D.: 8.5mm;with/without ferrite
24AWG	20 meters	O.D.: 10.0mm;with/without ferrite

LH02-1036

Other Gauge	UP to length	Specification
28+30AWG	10 meters	O.D.: 6.5mm;with/without ferrite
26+28AWG	15 meters	O.D.: 8.0mm;with/without ferrite
24+28AWG	20 meters	O.D.: 8.8mm;with/without ferrite
24+26AWG	20 meters	O.D.: 9.5mm;with/without ferrite

Gauge	UP to length	Specification
24AWG/26AWG/ 26+28AWG	25-40 meters	with one IC Amplifier
24AWG/24+28AWG/ 24+26AWG	50 meters	with one IC Amplifier
24AWG/24+26AWG	60-70 meters	with two IC Amplifier

IC Amplifier moulding in plug

IC Amplifier inside



Item NO.	Product Description
----------	---------------------

LH02-1037	HDMI Flat cable, A male to A male,moulding type
-----------	---

LH02-1038	HDMI Flat cable, one side angle type A male to A male, moulding type
-----------	--

LH02-1039	HDMI Flat cable, tow side angle type A male to A male, moulding type
-----------	--

LH02-1040	HDMI Round cable, one side angle type A male to A male, moulding type
-----------	---

LH02-1041	HDMI Round cable, tow side angle type A male to A male, moulding type
-----------	---

LH02-1042	HDMI Round cable, one side angle type A male to A male, moulding type
-----------	---

LH02-1043	HDMI Round cable, tow side angle type A male to A male, moulding type
-----------	---

LH02-1044	HDMI cable, A male to A female,moulding type
-----------	--

LH02-1045	HDMI cable, A normal male to A male, with Screws, moulding type
-----------	---

LH02-1046	HDMI cable, A normal female to A female with 2 Screws, moulding type
-----------	--





Item NO.	Product Description
LH02-1047	HDMI A male to A male, single moulding type
LH02-1048	HDMI A male to mini C male, single moulding type
LH02-1049	HDMI A male to micro D male, single moulding type

Item NO.	Product Description
LH02-1050	HDMI A male to A male, metal shell type
LH02-1051	HDMI A male to mini C male, metal shell type
LH02-1052	HDMI A male to micro D male, metal shell type

Item NO.	Product Description
LH02-1053	HDMI A male to A male, metal shell type
LH02-1054	HDMI A male to mini C male, metal shell type
LH02-1055	HDMI A male to micro D male, metal shell type

LH02-1056



LH02-1057



LH02-1058



LH02-1059



LH02-1060



LH02-1061



LH02-1062



LH02-1063



LH02-1064



Product Description

- * OEM any kinds of double color plugs
- * With Company logo
- * With Nylon and Cotton braiding sleeve
- * With ferrites / without ferrites



Item NO.	Product Description
LH02-1065	HDMI A male to A male, aluminum shell moulding type with/without nylon or cotton sleeve
LH02-1066	HDMI A male to A male, aluminum shell moulding type with/without nylon or cotton sleeve
LH02-1067	HDMI A male to A male, aluminum shell moulding type with/without nylon or cotton sleeve
LH02-1068	HDMI A male to A male flat cable, aluminum shell moulding type with/without nylon or cotton sleeve
LH02-1069	HDMI A male to A male flat cable, aluminum shell moulding type with/without nylon or cotton sleeve
LH02-1070	HDMI A male to A male flat cable, metal shell assembly type with/without nylon or cotton sleeve
LH02-1071	HDMI A male to A male, metal shell moulding type with/without nylon or cotton sleeve
LH02-1072	HDMI A male to A male, metal shell moulding type with/without nylon or cotton sleeve
LH02-1073	HDMI A male to A male, metal shell moulding type with/without nylon or cotton sleeve

Item NO.	Product Description
LH02-1074	HDMI A male to A male, full metal shell type with/without nylon or cotton sleeve
LH02-1075	HDMI A male to A male angle plug, full metal shell type with/without nylon or cotton sleeve
LH02-1076	HDMI A male to A male, full metal shell type with/without nylon or cotton sleeve
LH02-1077	HDMI A male to A male, full metal shell type with/without nylon or cotton sleeve
LH02-1078	HDMI A male to A male, full metal shell type with/without nylon or cotton sleeve
LH02-1079	HDMI A male to A male, full metal shell type with/without nylon or cotton sleeve
LH02-1080	HDMI A male to A male, full metal shell type with/without nylon or cotton sleeve
LH02-1081	HDMI A male to A male flat cable, full metal shell type with/without nylon or cotton sleeve
LH02-1082	HDMI A male to A male flat cable, full metal shell type with/without nylon or cotton sleeve



HDMI CABLE



180° Rotating HDMI cable

LH02-1083



LH02-1084

360° Rotating HDMI cable



LH02-1085



LH02-1086



Product Description

HDMI LED lighting plugs cable;
 red,green,blue,yellow,purple,and continuing changing colors;
 Full HD 1080P and 3D;
 4K*2K compatible;
 moulding plugs & metal shell plugs any type can OEM for you;

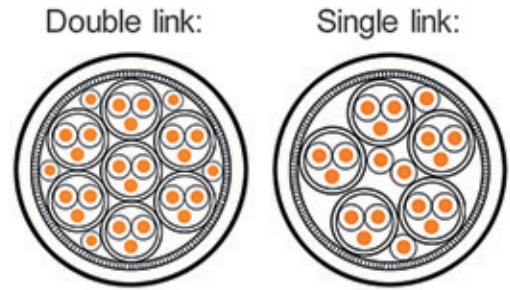
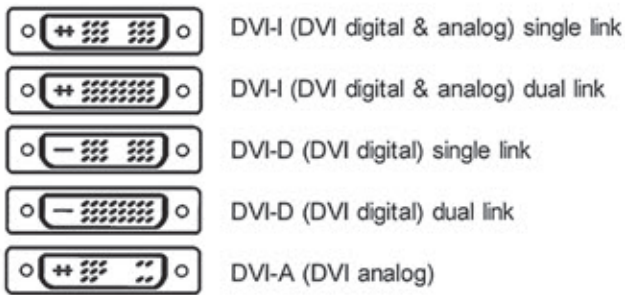

Description

- *Rated temperature:80°C
- *Rated voltage: 30V
- *Reference standard: DDWG specification revision 1.0
- *Stranded bare or tinned copper conductor, 30-24AWG
- *Color-coded foam PE or PE insulation
- *Two foam PE insulated cores twisted as signal pair
- *Tinned copper or copper alloy braid shield
- *Lead free PVC jacket
- *Passes UL VW-1 & CSA FT1 vertical flame test

Application

- *Digital video interface between a PC & VGA monitor
- *High-quality video displays for HDTV, Plasma, LCD monitors, DVD players.



Item No.	Product Description	Gauge	Instruction
LH02-1087	HDMI male to DVI male		
LH02-1087	DVI male to DVI male		
LH02-1087	VGA male to DVI male		
LH02-1088	HDMI male to DVI male(Double color)		
LH02-1088	DVI male to DVI male(Double color)		
LH02-1089	HDMI male to DVI male(metal shell)		
LH02-1089	DVI male to DVI male(metal shell)		
		30AWG 28AWG 26AWG 24AWG 24+28AWG 24+26AWG	30AWG up to 7 meters 28AWG up to 12 meters 26AWG up to 15 meters 24AWG up to 25 meters 24+28AWG up to 25 meters 24+26AWG up to 25 meters

Construction:

3+4
3+6
3+7
3+8
3+9



5+5



Product Description:

Rated temperature:80°C Rated voltage:30V

Tinned copper stranded

Cellular PE(coax.)

Color-coded semi-rigid PVC(hook-up wire)

Tinned copper wire spiral or braided shield(coax.)

Tinned stranded copper drain wire

Drain wire laid between aluminum mylar and braid

Tinned or bare copper wire overall more than 85% coverage

braid shield

PVC jacketed

Pass UL VW-1 vertical flame test

Electrical Properties:

Conductor resistance:20°C(max.)

25AWG:237.25Ω/km(coax.)

24AWG:93.25Ω/km(core.)

Impedance:at 10MHz,75Ω±5Ω(coax.)

ITEM NO.: LHVGA-01MM (VGA male to male)

ITEM NO.: LHVGA-01MF (VGA male to female)

Gauge	UP to length	Specification
30AWG	20 meters	O.D.: 6.0mm;with/without ferrite
28AWG	40 meters	O.D.: 7.3mm;with/without ferrite
26AWG	60 meters	O.D.: 8.5mm;with/without ferrite
24AWG	80 meters	O.D.: 10.0mm;with/without ferrite



LH02-1090



LH02-1091



Construction:



- * Rated temperature:80°C Rated voltage:30V
- * coaxial cable stranded
- * with 3.5 stereo audio cable



LH02-1092

ITEM NO.: LHVG- 10

Gauge	UP to length	Specification
30AWG	20 meters	O.D.: 6.0mm;with/without ferrite
28AWG	40 meters	O.D.: 7.3mm;with/without ferrite
26AWG	60 meters	O.D.: 8.5mm;with/without ferrite
24AWG	80 meters	O.D.: 10.0mm;with/without ferrite

Construction:

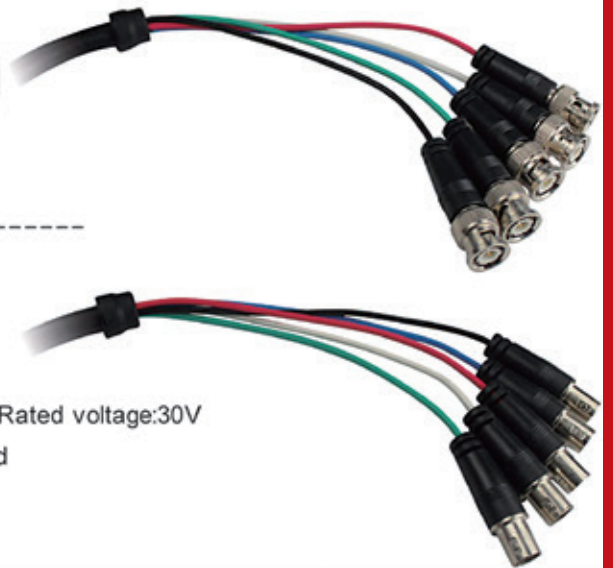
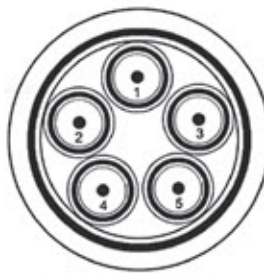

- * Rated temperature:80°C Rated voltage:30V
- * 5 coaxial cables stranded

Item No.	Product Description	Gauge	UP to length	Specification
LH02-1093	VGA male to 5*BNC male	30AWG	20 meters	O.D.: 6.0mm;with/without ferrite
LH02-1094	VGA male to 5*BNC female	28AWG	40 meters	O.D.: 7.3mm;with/without ferrite
LH02-1095	VGA female to 5*BNC male	26AWG	60 meters	O.D.: 8.5mm;with/without ferrite
LH02-1096	VGA female to 5*BNC female	24AWG	80 meters	O.D.: 10.0mm;with/without ferrite

LH02-1097

A: 3.5MM STEREO PLUG TO 3.5MM STEREO PLUG CABLE
 B: 3.5MM STEREO PLUG TO 3.5MM STEREO JACK CABLE



LH02-1103

A: 3.5MM STEREO PLUG TO 3.5MM STEREO PLUG FLAT CABLE, METAL PLUG
 B: 3.5MM STEREO PLUG TO 3.5MM STEREO JACK FLAT CABLE, METAL PLUG



LH02-1109

USB AM - IPHONE LIGHTNING 8P CABLE



LH02-1098

A: 3.5MM STEREO PLUG TO 3.5MM STEREO PLUG CABLE OD:2.0MM
 B: 3.5MM STEREO PLUG TO 3.5MM STEREO JACK CABLE OD:2.0MM



LH02-1104

3.5MM STEREO 4C PLUG TO 3.5MM STEREO 4C PLUG FLAT CABLE, METAL PLUG



LH02-1110

USB AM - IPHONE 30P CABLE



LH02-1099

3.5MM STEREO PLUG TO 3.5MM STEREO PLUG CABLE OD:3.0MM



LH02-1105

3.5MM STEREO PLUG TO 3.5MM STEREO PLUG FLAT CABLE, METAL PLUG WITH MESH JACKET

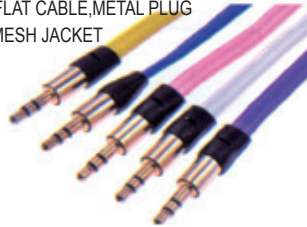

LH02-1111

USB AM TO MICRO 5P CABLE



LH02-1100

3.5MM 4C PLUG TO 3.5MM 4C PLUG CABLE, ABS PLUG



LH02-1106

3.5MM STEREO PLUG TO 3.5MM STEREO PLUG FLAT CABLE



LH02-1112

USB AM TO 3.0 MICRO CABLE WITH ABS PLUG



LH02-1101

3.5MM STEREO PLUG TO 3.5MM STEREO PLUG CABLE, METAL PLUG WITH MESH JACKET

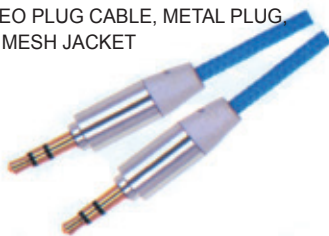

LH02-1107

3.5MM STEREO PLUG TO 3.5MM STEREO PLUG FLAT CABLE

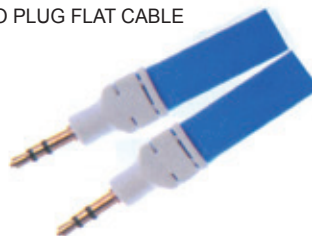

LH02-1113

USB AM TO LIGHTNING 8P FLAT CABLE



LH02-1102

3.5MM STEREO PLUG TO 3.5MM STEREO PLUG FLAT CABLE



LH02-1108

3.5MM STEREO PLUG TO 3.5MM STEREO PLUG COIL FLAT CABLE, METAL PLUG



LH02-1114

USB AM TO MICRO 5P FLAT CABLE



LH02-1115

USB AM TO iPhone 30P FLAT CABLE



LH02-1121

USB AM TO LIGHTNING 8P FLAT CABLE , METAL PLUG



LH02-1127

HEADPHONG SHARING DEVICE WITH 3.5MM CABLE
COLOR: BLACK, WHITE, BLUE, RED, PURPLE, GREEN



LH02-1116

USB AM TO LIGHTNING 8P CABLE



LH02-1122

USB AM TO MICRO 5P FLAT CABLE , METAL PLUG



LH02-1128

USB AM TO iPhone 8P COIL CABLE
COLORS:RED,GREEN,BLUE



LH02-1117

USB AM TO 3.0 MICRO CABLE



LH02-1123

USB AM TO iPhone 30P FLAT CABLE
METAL PLUG



LH02-1129

USB AM TO MICRO 5P COIL CABLE
COLORS:RED,GREEN,BLUE



LH02-1118

USB AM TO MICRO 5P CABLE



LH02-1124

USB AM - LIGHTNING 8P RETRACTABLE



LH02-1130

USB AM TO MICRO 5P / LIGHTNING 8P



LH02-1119

USB AM TO iPhone 30P CABLE



LH02-1125

USB AM - LIGHTNING 8P / MICRO 5P
/ iPhone 30P RETRACTABLE



LH02-1131

USB AM TO MICRO 5P / LIGHTNING 8P / iPhone 30P



LH02-1120

USB AM TO 3.0 MICRO CABLE
METAL PLUG



LH02-1126

USB AM TO LIGHTNING 8P RETRACTABLE,
METAL PLUG



LH02-1132

USB AM TO MICRO 5P / LIGHTNING 8P / iPhone 30P





PORTABLE AND EASY HANDLE

LH02-1133
USB AM (C TYPE) TO LIGHTNING 8P
CABLE



LH02-1134
USB AM (C TYPE) TO MICRO 5P
CABLE



LH02-1135
USB AM (C TYPE) TO iPhone
30P CABLE



LH02-1136

USB CAR CHARGER
INPUT: 12-24V
OUTPUT: 5V-1A



LH02-1142

DUAL USB CAR CHARGER
INPUT: 12-24V
OUTPUT: 5V-3.1A
(1A+2.1A)



LH02-1148

(U.S. TYPE)
DUAL USB HOME CHARGER
INPUT: AC 100-240V
OUTPUT: DC 5V/2.4A

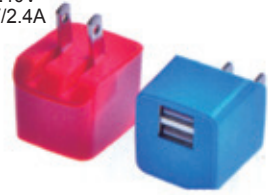

LH02-1137

DUAL USB CAR CHARGER
INPUT: 12-24V
OUTPUT: 5V-3.1A (1A+2.1A)



LH02-1143

DUAL USB CAR CHARGER
INPUT: 12-24V
OUTPUT: 5V-2.1A
(1A+1.1A)



LH02-1149

(U.S. TYPE)
DUAL USB HOME CHARGER
INPUT: AC 100-240V
OUTPUT: DC 5V/3.1A



LH02-1138

USB CAR CHARGER
INPUT: 12-24V
OUTPUT: 5V-1A



LH02-1144

DUAL USB CAR CHARGER
INPUT: 12-24V
OUTPUT: 5V-3.1A
(1A+2.1A)



LH02-1150

(EUROPEAN TYPE)
USB HOME CHARGER
INPUT: AC 100-240V
OUTPUT: DC 5V/1A



LH02-1139

USB CAR CHARGER
INPUT: 12-24V
OUTPUT: 5V-2.4A



LH02-1145

(EUROPEAN TYPE)
USB HOME CHARGER
INPUT: AC 100-240V
OUTPUT: DC 5V/1A



LH02-1151

(EUROPEAN TYPE)
USB HOME CHARGER
INPUT: AC 100-240V
OUTPUT: DC 5V/3.1A



LH02-1140

USB CAR CHARGER
INPUT: 12-24V
OUTPUT: 5V-2.4A



LH02-1146

(EUROPEAN TYPE)
USB HOME CHARGER
INPUT: AC 100-240V
OUTPUT: DC 5V/1A



LH02-1152

(U.S. TYPE)
USB HOME CHARGER WITH
FOUR USB PORT
INPUT: AC 100-240V
OUTPUT: DC 5V/4.2A



LH02-1141

DUAL USB CAR CHARGER
INPUT: 12-24V
OUTPUT: 5V-3.1A
(1A-2.1A)



LH02-1147

(U.S. TYPE)
USB HOME CHARGER
INPUT: AC 100-240V
OUTPUT: DC 5V/1A



LH02-1153

(EUROPEAN TYPE)
POWER CHARGER WITH USB
MICRO 5PIN CABLE



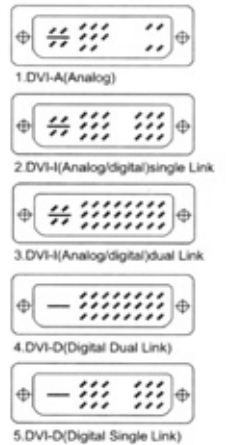
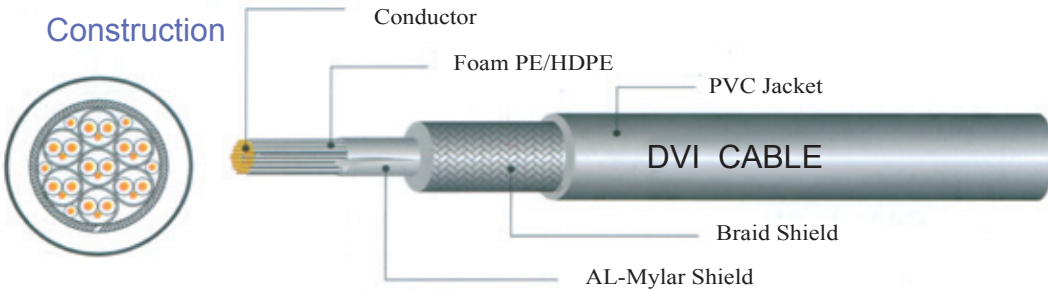

Description

- Rated temperature: 80°C
- Rated voltage: 30V
- Reference standard: DDWG Specification Revision 1.0
- Stranded bare or tinned copper conductor, 30-24AWG
- Color-coded Foam PE or PE Insulation
- Two Foam PE insulated cores twisted as signal pair
- Tinned copper or copper alloy braid shield
- Lead free PVC jacket
- Passes UL VW-1 & CSA FT1 vertical flame test

Application

- Digital video interface between a PC & VGA monitor
- High-quality video displays for HDTV, Plasma, LCD monitors, DVD players

Electrical Characteristic

- Differential Impedance at 20°C: 100 ± 10Ω
- Common Mode Impedance at 20°C: 33 ± 10Ω
- Differential Delay: ≤ 4.50ns/m
- Propagation delay skew: within a pair: ≤ 450ps/m
between pairs: ≤ 1.05ns/m
- Rise Time Degradatio B: 1.65GHz, ≤ 212ps

LH02-1154

DVI PLUG TO DVI PLUG
A:(18+1)
B:(24+1)
C:(24+5)



LH02-1157

DVI PLUG TO HDMI PLUG
A:(18+1)
B:(24+1)
C:(24+5)



LH02-1160

DVI PLUG TO HDMI PLUG, METAL PLUG
A:(18+1)
B:(24+1)
C:(24+5)



LH02-1155

DVI PLUG TO DVI PLUG, METAL PLUG
A:(18+1)
B:(24+1)
C:(24+5)



LH02-1158

DVI PLUG TO HDMI PLUG,
A:(18+1)
B:(24+1)
C:(24+5)



LH02-1161

DVI PLUG TO VGA PLUG
A:(18+1)
B:(24+1)
C:(24+5)



LH02-1156

DVI PLUG TO HDMI PLUG
A:(18+1)
B:(24+1)
C:(24+5)



LH02-1159

DVI PLUG TO HDMI PLUG,
DOUBLE COLOR
A:(18+1)
B:(24+1)
C:(24+5)



LH02-1162

DVI PLUG TO 3 RCA PLUG
A:(18+1)
B:(24+1)
C:(24+5)



LH02-1163

MICRO HDMI MALE TO HDMI FEMALE ADAPTOR, SWIVEL TYPE
A:GOLD
B:NICKEL



LH02-1169

HDMI FEMALE TO MICRO HDMI MALE ADAPTOR
A:GOLD
B:NICKEL



LH02-1175

HDMI FEMALE TO MINI HDMI MALE ADAPTOR
A:GOLD
B:NICKEL



LH02-1164

MICRO HDMI MALE TO HDMI FEMALE ADAPTOR
360° ROTATABLE
A:GOLD
B:NICKEL



LH02-1170

HDMI FEMALE TO MICRO HDMI MALE ADAPTOR
A:GOLD
B:NICKEL



LH02-1176

HDMI FEMALE TO MINI HDMI MALE ADAPTOR
A:GOLD
B:NICKEL



LH02-1165

MICRO HDMI MALE TO HDMI FEMALE ADAPTOR,
90° ANGLE TYPE
A:GOLD
B:NICKEL



LH02-1171

HDMI MALE TO MICRO HDMI FEMALE ADAPTOR
A:GOLD
B:NICKEL



LH02-1177

HDMI MALE TO MINI HDMI FEMALE ADAPTOR
A:GOLD
B:NICKEL



LH02-1166

MICRO HDMI MALE TO HDMI FEMALE ADAPTOR,
90° ANGLE TYPE
A:GOLD
B:NICKEL



LH02-1172

MINI HDMI MALE TO HDMI FEMALE ADAPTOR, SWIVEL TYPE
A:GOLD
B:NICKEL



LH02-1178

HDMI MALE TO HDMI FEMALE ADAPTOR,
360° ROTATABLE
A:GOLD
B:NICKEL



LH02-1167

MICRO HDMI MALE TO MICRO HDMI FEMALE ADAPTOR,
A:GOLD
B:NICKEL



LH02-1173

MINI HDMI MALE TO HDMI FEMALE ADAPTOR,
360° ROTATABLE
A:GOLD
B:NICKEL



LH02-1179

HDMI MALE TO HDMI FEMALE ADAPTOR,
SWIVEL TYPE
A:GOLD
B:NICKEL



LH02-1168

MICRO HDMI MALE TO MINI HDMI FEMALE ADAPTOR,
A:GOLD
B:NICKEL



LH02-1174

HDMI MALE TO HDMI MINI FEMALE ADAPTOR,
SWIVEL TYPE
A:GOLD
B:NICKEL



LH02-1180

HDMI MALE TO HDMI FEMALE ADAPTOR,
SWIVEL TYPE
A:GOLD
B:NICKEL



LH02-1181

HDMI FEMALE TO HDMI FEMALE ADAPTOR,
SWIVEL TYPE
A:GOLD
B:NICKEL



LH02-1187

HDMI FEMALE TO HDMI FEMALE ADAPTOR,
90° ANGLE TYPE
A:GOLD
B:NICKEL



LH02-1193

HDMI MALE TO HDMI FEMALE ADAPTOR
-A:GOLD
B:NICKEL



LH02-1182

HDMI FEMALE TO HDMI FEMALE ADAPTOR,
360° ROTATABLE
A:GOLD
B:NICKEL



LH02-1188

HDMI FEMALE TO HDMI FEMALE ADAPTOR,
90° ANGLE TYPE
A:GOLD
B:NICKEL



LH02-1194

HDMI FEMALE TO HDMI MALE ADAPTOR,
90° ANGLE TYPE
A:GOLD
B:NICKEL



LH02-1183

HDMI FEMALE TO HDMI FEMALE ADAPTOR,
A:GOLD
B:NICKEL



LH02-1189

HDMI FEMALE TO HDMI FEMALE PANEL
ADAPTOR
A:GOLD
B:NICKEL



LH02-1195

HDMI MALE TO HDMI FEMALE ADAPTOR,
270° ROTATABLE
A:GOLD
B:NICKEL



LH02-1184

HDMI FEMALE TO HDMI FEMALE ADAPTOR,
A:GOLD
B:NICKEL



LH02-1190

HDMI FEMALE TO HDMI FEMALE PANEL
ADAPTOR
90° ANGLE TYPE
A:GOLD
B:NICKEL



LH02-1196

HDMI MALE TO HDMI FEMALE ADAPTOR,
SWIVEL TYPE
A:GOLD
B:NICKEL



LH02-1185

HDMI FEMALE TO HDMI FEMALE ADAPTOR,
A:GOLD
B:NICKEL



LH02-1191

HDMI FEMALE TO HDMI FEMALE ADAPTOR,
270° ROTATABLE
A:GOLD
B:NICKEL



LH02-1197

HDMI MALE TO HDMI FEMALE ADAPTOR,
90° ANGLE TYPE
A:GOLD
B:NICKEL



LH02-1186

HDMI FEMALE TO HDMI FEMALE ADAPTOR,
A:GOLD
B:NICKEL



LH02-1192

HDMI MALE TO HDMI FEMALE ADAPTOR
A:GOLD
B:NICKEL



LH02-1198

HDMI MALE TO HDMI FEMALE ADAPTOR,
90° ANGLE TYPE
A:GOLD
B:NICKEL



LH02-1199

HDMI MALE TO HDMI FEMALE ADAPTOR,
90° ANGLE TYPE
A:GOLD
B:NICKEL



LH02-1200

HDMI JACK TO HDMI JACK RIGHT ANGLE
ADAPTOR
A:GOLD
B:NICKEL



LH02-1201

HDMI PLUG TO HDMI JACK RIGHT
ANGLE ADAPTOR
A:GOLD
B:NICKEL



LH02-1202

HDMI MALE TO HDMI FEMALE ADAPTOR,
90° ANGLE TYPE
A:GOLD
B:NICKEL



LH02-1203

HDM MALE TO HDMI MALE ADAPTOR
A:GOLD
B:NICKEL



LH02-1204

DVI(18+1) MALE TO HDMI FEMALE ADAPTOR
A:GOLD
B:NICKEL



LH02-1205

DVI(24+1) MALE TO HDMI FEMALE ADAPTOR
A:GOLD
B:NICKEL



LH02-1206

DVI(18+1) MALE TO HDMI FEMALE ADAPTOR
A:GOLD
B:NICKEL



LH02-1207

DVI(18+1) MALE TO HDMI FEMALE ADAPTOR
A:GOLD
B:NICKEL



LH02-1208

DVI(24+5) FEMALE TO HDMI MALE ADAPTOR
A:GOLD
B:NICKEL



LH02-1209

DVI(24+5) FEMALE TO HDMI MALE ADAPTOR
A:GOLD
B:NICKEL



LH02-1210

DVI(24+5) FEMALE TO HDMI FEMALE ADAPTOR
A:GOLD
B:NICKEL



LH02-1211

DVI(24+1) MALE TO HDMI FEMALE ADAPTOR
270° ROTATABLE
A:GOLD
B:NICKEL



LH02-1212

DVI(18+1) MALE TO HDMI FEMALE ADAPTOR
270° ROTATABLE
A:GOLD
B:NICKEL



LH02-1213

DVI(18+1) MALE TO HDMI MALE ADAPTOR,
270° ROTATABLE
A:GOLD
B:NICKEL



LH02-1214

DVI(24+1) MALE TO HDMI MALE ADAPTOR,
270° ROTATABLE
A:GOLD
B:NICKEL

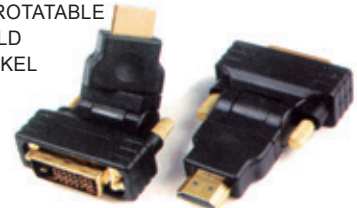

LH02-1215

DVI(24+5) FEMALE TO DVI(24+5) FEMALE
ADAPTOR
A:GOLD
B:NICKEL

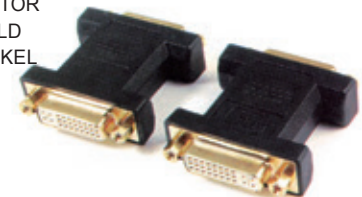

LH02-1216

DVI(24+5) MALE TO DVI(24+5) FEMALE ADAPTOR
A:GOLD
B:NICKEL



LH02-1217

DVI(24+5) FEMALE TO DVI(24+1) MALE ADAPTOR,
A:GOLD
B:NICKEL

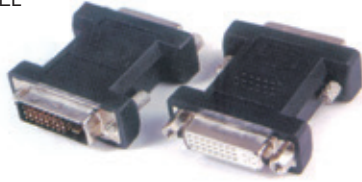

LH02-1223

DVI(12+5) MALE TO VGA FEMALE ADAPTOR
A:GOLD
B:NICKEL

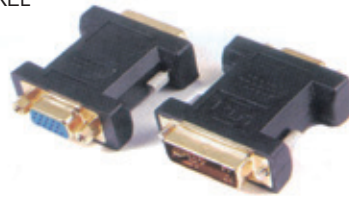

LH02-1229

DVI(24+5) FEMALE TO VGA MALE ADAPTOR
A:GOLD
B:NICKEL

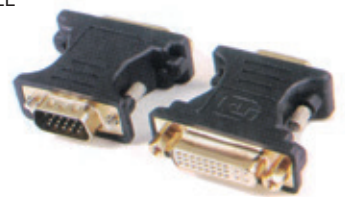

LH02-1218

DVI(24+5) MALE TO DVI(24+5) MALE ADAPTOR
A:GOLD
B:NICKEL



LH02-1224

DVI(24+5) FEMALE TO VGA FEMALE ADAPTOR
A:GOLD
B:NICKEL

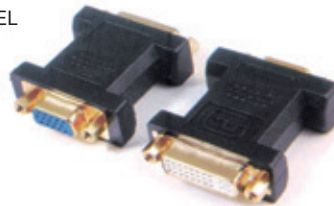

LH02-1230

DVI(24+5) MALE TO VGA FEMALE ADAPTOR
A:GOLD
B:NICKEL



LH02-1219

DVI(12+5) MALE TO 3RCA FEMALE ADAPTOR
A:GOLD
B:NICKEL



LH02-1225

DVI(24+5) FEMALE TO VGA MALE ADAPTOR
A:GOLD
B:NICKEL



LH02-1231

DVI(18+5) SHELL
A:GOLD
B:NICKEL



LH02-1220

DVI(18+5) MALE TO 3RCA FEMALE ADAPTOR
A:GOLD
B:NICKEL



LH02-1226

VGA FEMALE TO VGA FEMALE ADAPTOR
A:GOLD
B:NICKEL



LH02-1232

DVI(24+1) SHELL
A:GOLD
B:NICKEL



LH02-1221

DVI(24+5) MALE TO VGA MALE ADAPTOR
A:GOLD
B:NICKEL



LH02-1227

VGA MALE TO VGA FEMALE ADAPTOR
A:GOLD
B:NICKEL

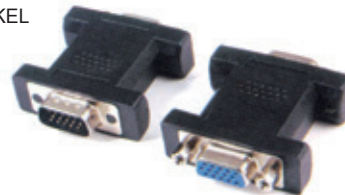

LH02-1233

DVI(24+5) SHELL
A:GOLD
B:NICKEL

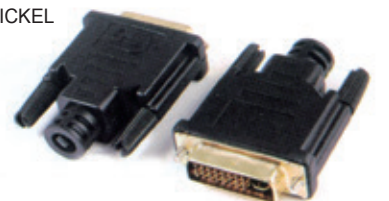

LH02-1222

DVI(24+5) MALE TO VGA FEMALE ADAPTOR
A:GOLD
B:NICKEL



LH02-1228

VGA MALE TO VGA MALE ADAPTOR
A:GOLD
B:NICKEL



LH02-1234

HDMI A FEMALE TO HDMI MINI MALE
+MICRO MALE ADAPTOR
A:GOLD
B:NICKEL



LH02-1235
1X2 HDMI SPLITTER



FC CE RoHS compliant 3D A 1080P FULL HD B 4KX2K UHD



LH02-1236
1X4 HDMI SPLITTER



FC CE RoHS compliant 3D A 1080P FULL HD B 4KX2K UHD



LH02-1237
1X8 HDMI SPLITTER



FC CE RoHS compliant 3D A 1080P FULL HD B 4KX2K UHD



LH02-1238
1X12 HDMI SPLITTER



FC CE RoHS compliant 3D A 1080P FULL HD B 4KX2K UHD

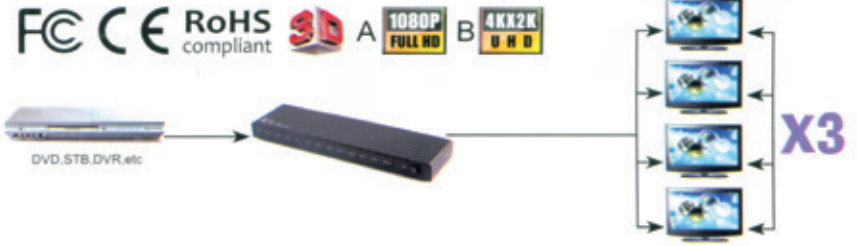

LH02-1239
1X16 HDMI SPLITTER



FC CE RoHS compliant 3D A 1080P FULL HD B 4KX2K UHD

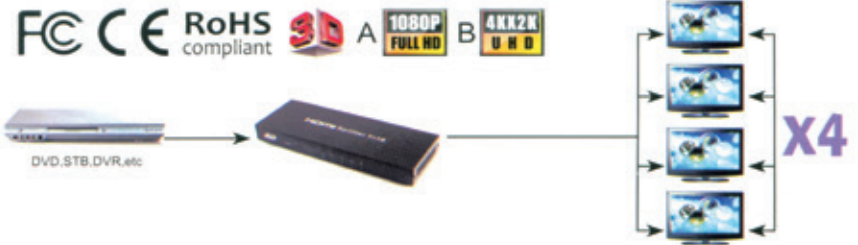

LH02-1240
4x4 HDMI MATRIX
4 INPUTS
4 OUTPUTS



LH02-1242
2x4 HDMI MATRIX
2 INPUTS
4 OUTPUTS



LH02-1241
4x2 HDMI MATRIX
4 INPUTS
2 OUTPUTS



LH02-1243
2x8 HDMI MATRIX
2 INPUTS
8 OUTPUTS



HDMI SPLITTER

LH02-1244

2x1 HDMI SWITCH

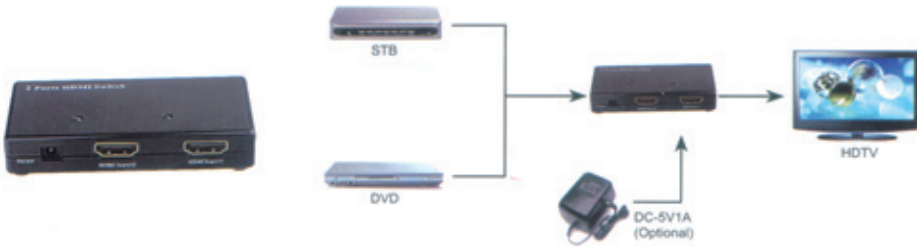

LH02-1249

2x1 HDMI SWITCH BOX



LH02-1245

3x1 HDMI SWITCH

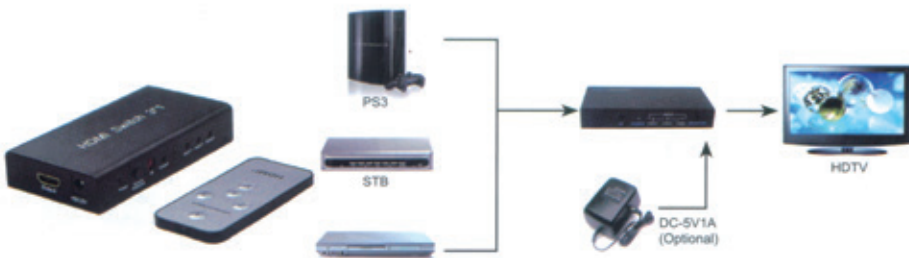

LH02-1250

3x1 HDMI SWITCH BOX



LH02-1246

4x1 HDMI SWITCH



LH02-1251

4x1 HDMI SWITCH BOX



LH02-1247

5x1 HDMI SWITCH



LH02-1252

3x1 HDMI SWITCH PIGTAIL



LH02-1248

3x1 HDMI SWITCH WITH REMOTE CONTROL, PLASTIC COVER



LH02-1245

3x1 HDMI SWITCH WITHOUT REMOTE CONTROL, PLASTIC COVER



LH02-1253

5x1 HDMI SWITCH WITH REMOTE CONTROL, PLASTIC COVER



LH02-1254
HDMI REPEATER



LH02-1255
HDMI REPEATER



LH02-1256
HDMI EXTENDER
A:30M
B:60M

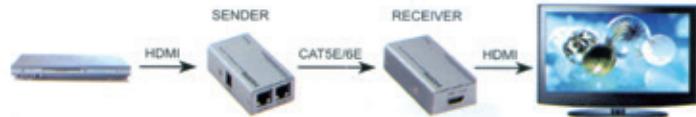

LH02-1257
HDMI EXTENDER
30M

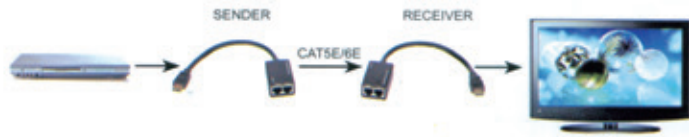

LH02-1258
WII-LINK HDMI ADAPTER
HD 1080P



LH02-1259
WII-LINK HDMI ADAPTER
PASS THROUGH



LH02-1260
PSP CONVERTER



LH02-1261

1X2 VGA SPLITTER 150MHZ



LH02-1266

1X2 VGA SPLITTER 350MHZ



LH02-1270

1X8 VGA SPLITTER 350MHZ



LH02-1262

1X4 VGA SPLITTER 150MHZ



LH02-1267

1X2 VGA SPLITTER WITH AUDIO 350MHZ



LH02-1271

HDMI BI-DIRECTION SWITCH (SUPPORT 4K 3D)



LH02-1263

1X4 VGA SPLITTER WITH AUDIO 150MHZ



LH02-1268

1X4 VGA SPLITTER 350MHZ



LH02-1264

1X8 VGA SPLITTER 150MHZ



LH02-1269

1X4 VGA SPLITTER WITH AUDIO 350MHZ



LH02-1265

NETWORKING DISPLAY ADAPTER



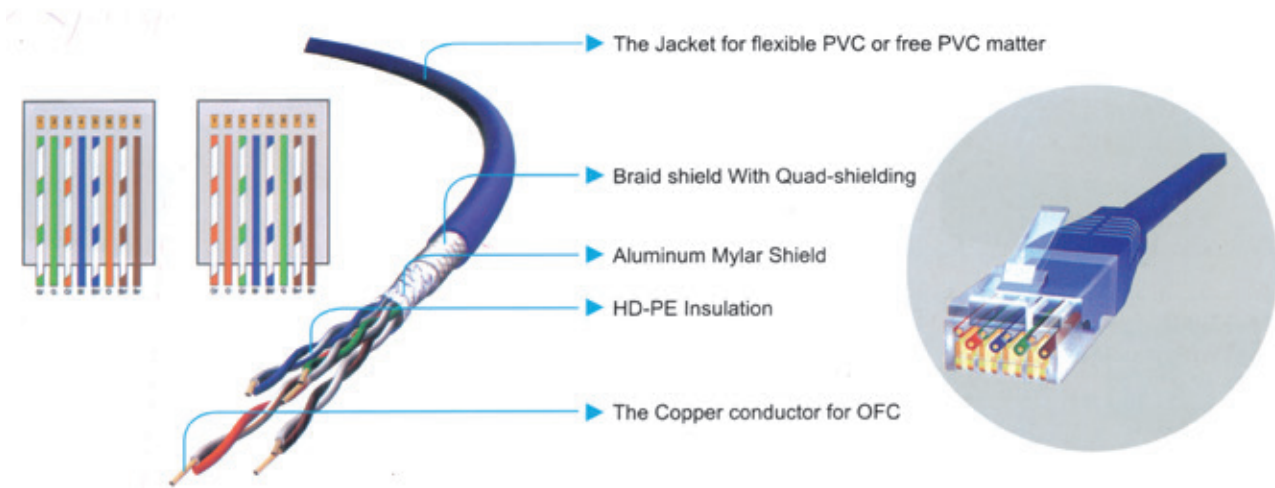

LH06-1272

CAT5E UTP PATCH CORD CABLE
 A: T568A
 B: T568B
 C: CROSSOVER



LH06-1276

CAT6 UTP PATCH CORD CABLE
 A: T568A
 B: T568B
 C: CROSSOVER
 FLAT CABLE



LH06-1273

CAT6 UTP PATCH CORD CABLE
 A: T568A
 B: T568B
 C: CROSSOVER



LH06-1277

CAT5E UTP PATCH CORD CABLE
 A: T568A
 B: T568B
 C: CROSSOVER
 RETRACTABLE



LH06-1274

CAT5E FTP PATCH CORD CABLE
 A: T568A
 B: T568B
 C: CROSSOVER



LH06-1278

CAT5E UTP PATCH CORD EXTENSION CABLE
 A: T568A
 B: T568B
 C: CROSSOVER

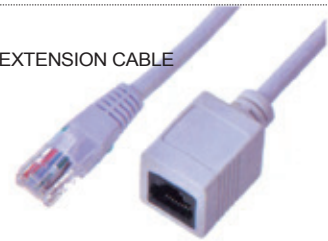

LH06-1275

CAT6 FTP PATCH CORD CABLE
 A: T568A
 B: T568B
 C: CROSSOVER



LH06-1279

CAT6 UTP PATCH CORD EXTENSION CABLE
 A: T568A
 B: T568B
 C: CROSSOVER

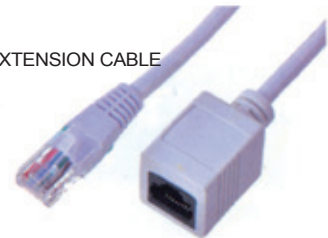

AVAILABLE CAP

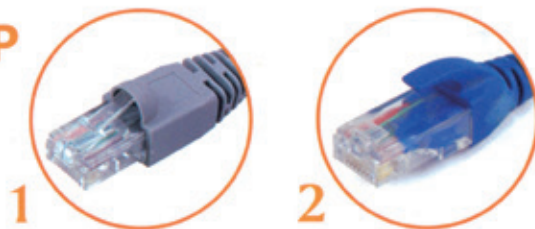

UTP CATEGORY 5E LAN Cable

General Specification

Standard	Application
ISO/IEC 11801-2Ed	10/100BASE(TIEEE 802.3)
ANSI TIA/EIA 568-B.2	ATM,TP-PMD,ANSI X39T.5(TP),LSDN,TP-DDI
EN 50173	Ethernet,1000BASE-T
EN-50288-3-1	GIGABIT-Ethernet
UL & 3P	Token Ring (IEEE802.5)

Electrical Specification

Dielectric strength	2.5KV dc-2seconds
conductor resistance	Max 9.38Ohm/100mt at 20°C
Max. ring resistance	16.8 Ohm/100mt at 20°C
Max. mutual capacitance	560pf/100mt
Max. capacity unbalance	330 pf/100mt
standard impedance	100 ± 15 Ohm between 1Mhz and 350Mhz
Minimum bending radius	50mm
Working temperatures	-20 ~ 60°C

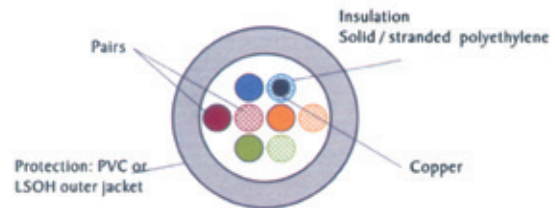

Frequency (Mhz)	RL (dB)	ATT (dB/100)	NEXT (dB)	PS-NEXT (dB)	ACR (dB)	PS-ACR (dB)	ELFEXT (dB)	PS-ELFEXT (dB)
1Mhz	20	2.1	68	66	66.3	64.3	63.8	60.8
4Mhz	23	4.2	59.2	57.2	55.2	53.2	51.7	48.8
8Mhz	24.5	5.9	54.8	52.8	49	47	45.7	42.7
10Mhz	25	6.6	53.3	51.3	46.8	44.8	43.8	40.8
16Mhz	25	8.3	50.3	48.3	42.1	40.1	39.7	36.7
20Mhz	25	9.4	48.8	46.8	39.5	37.5	37.8	34.8
25Mhz	24.3	10.3	47.3	45.3	36.9	34.9	35.8	32.8
31.25Mhz	23.6	11.8	45.9	43.9	34.2	32.2	33.9	30.9
62.5Mhz	21.5	17.1	41.4	39.4	24.4	22.4	27.8	24.8
100Mhz	20.1	22.2	38.3	36.3	16.3	14.3	23.8	20.8
155Mhz	18.8	28.2	35.4	33.4	7.4	5.4	20	17
200Mhz	18	32.5	33.7	31.7	1.4	0	17.7	14.7
240Mhz	17.4	36.1	32.6	30.6	-	-	16.2	13.2
300Mhz	16.8	41.1	31.2	29.2	-	-	14.2	11.2
350Mhz	16.3	45	30.1	28.1	-	-	12.9	9.9



F/UTP CATEGORY 5E LAN Cable

General Specification

Standard	Application
ISO/IEC 11801-2Ed	10/100BASE(TIEEE 802.3)
ANSI TIA/EIA 568-B.2	ATM,TP-PMD,ANSI X39T.5(TP),LSDN,TP-DDI
EN 50173	Ethernet,1000BASE-T
EN-50288-3-1	GIGABIT-Ethernet
	Token Ring (IEEE802.5)

Electrical Specification

Dielectric strength	2.5KV dc-2seconds
conductor resistance	Max 9.38Ohm/100mt at 20°C
Max. ring resistance	16.8 Ohm/100mt at 20°C
Max. mutual capacitance	560pf/100mt
Max. capacity unbalance	330 pf/100mt
standard impedance	100 ± 15 Ohm between 1Mhz and 100Mhz
Minimum bending radius	55mm
Working temperatures	-20 ~ 60°C

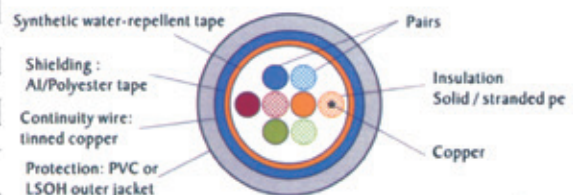

Frequency (Mhz)	RL (dB)	ATT (dB/100)	NEXT (dB)	PS-NEXT (dB)
0.772	20	1.8	67	64
1Mhz	20	2	65.3	62.3
4Mhz	23	4.1	56.3	53.3
8Mhz	24.5	5.8	51.8	48.8
10Mhz	25	6.5	50.3	47.3
16Mhz	25	8.2	47.3	44.3
20Mhz	25	9.3	45.8	42.8
25Mhz	24.3	10.4	44.3	41.3
31.25Mhz	23.3	11.7	42.9	39.9
62.5Mhz	20.7	17	38.4	35.4
100Mhz	19	22	35.3	32.3



SF/UTP CATEGORY 5E LAN Cable

General Specification

Standard	Application
ISO/IEC 11801-2Ed	10/100BASE(TIEEE 802.3)
ANSI TIA/EIA 568-B.2	ATM,TP-PMD,ANSI X39T.5(TP),LSDN,TP-DDI
EN 50173	Ethernet,1000BASE-T
EN-50288-3-1	GIGABIT-Ethernet
	Token Ring (IEEE802.5)

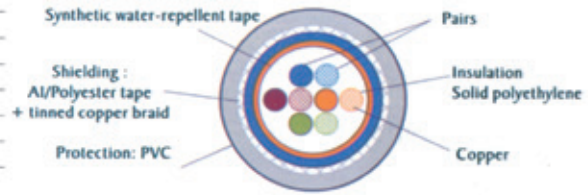

Electrical Specification

Dielectric strength	2.5KV dc-2seconds
conductor resistance	Max 9.38Ohm/100mt at 20°C
Max. ring resistance	16.8 Ohm/100mt at 20°C
Max. mutual capacitance	560pfl/100mt
Max. capacity unbalance	330 pfl/100mt
standard impedance	100 ± 15 Ohm between 1Mhz and 100Mhz
Minimum bending radius	55mm
Working temperatures	-20 ~ 60°C

Frequency (Mhz)	RL (dB)	ATT (dB/100)	NEXT (dB)	PS-NEXT (dB)
0.772	20	1.8	67	64
1MHz	20	2	65.3	62.3
4MHz	23	4.1	56.3	53.3
8MHz	24.5	5.8	51.8	48.8
10MHz	25	6.5	50.3	47.3
16MHz	25	8.2	47.3	44.3
20MHz	25	9.3	45.8	42.8
25MHz	24.3	10.4	44.3	41.3
31.25MHz	23.3	11.7	42.9	39.9
62.5MHz	20.7	17	38.4	35.4
100MHz	19	22	35.3	32.3



UTP CATEGORY 6 LAN Cable

General Specification

Standard	Application
ISO/IEC 11801-2Ed	10/100BASE(TIEEE 802.3)
ANSI TIA/EIA 568-B.2-1	ATM,TP-PMD,ANSI X39T.5(TP),LSDN,TP-DDI
EN 50173	Ethernet,1000BASE-T
EN-50288-3-1	GIGABIT-Ethernet
UL & 3P	Token Ring (IEEE802.5)

Electrical Specification

Dielectric strength	2.5KV dc-2seconds
conductor resistance	Max 9.38Ohm/100mt at 20°C
Max. ring resistance	16.8 Ohm/100mt at 20°C
Max. mutual capacitance	530pfl/100mt
Max. capacity unbalance	1100 pfl/100mt
standard impedance	100 ± 15 Ohm between 1Mhz and 250Mhz
Minimum bending radius	60mm
Working temperatures	-20 ~ 60°C

Frequency (Mhz)	Impedance (Ω)	RL (dB)	ATT (dB/100)	NEXT (dB)	PS-NEXT (dB)	ELFEXT (dB)	PS-ELFEXT (dB)
772MHz	100 ± 15	19.44	1.84	76	74	70	67
1MHz	100 ± 15	20	2.04	74.3	72.3	67.8	64.8
4MHz	100 ± 15	23.01	3.81	65.3	63.3	55.8	52.8
8MHz	100 ± 15	24.52	5.35	60.8	58.8	49.7	46.7
10MHz	100 ± 15	25	5.99	59.3	57.3	47.8	44.8
16MHz	100 ± 15	25	7.6	56.2	54.2	43.7	40.7
20MHz	100 ± 15	25	8.52	54.8	52.8	41.8	38.8
25MHz	100 ± 15	24.32	9.57	53.3	51.3	39.8	36.8
31.25MHz	100 ± 15	23.64	10.74	51.9	49.9	37.9	34.9
62.5MHz	100 ± 15	21.54	15.48	47.4	45.4	31.9	28.9
100MHz	100 ± 15	20.1	19.92	44.3	42.3	27.8	24.8
125MHz	100 ± 22	19.42	22.49	42.8	40.8	25.9	22.9
200MHz	100 ± 22	18	29.15	39.8	37.8	21.8	18.8
250MHz	100 ± 32	17.32	33.04	38.3	36.3	19.8	16.8



FTP CATEGORY 6 LAN Cable

General Specification

Standard	Application
ISO/IEC 11801-2Ed	10/100BASE(TIEEE 802.3)
ANSI TIA/EIA 568-B.2-1	ATM,TP-PMD,ANSI X39T.5(TP),LSDN,TP-DDI
EN 50173	Ethernet,1000BASE-T
EN-50288-3-1	GIGABIT-Ethernet
UL & 3P	Token Ring (IEEE802.5)

Electrical Specification

Dielectric strength	2.5KV dc-2seconds
conductor resistance	Max 9.38Ohm/100mt at 20°C
Max. ring resistance	16.8 Ohm/100mt at 20°C
Max. mutual capacitance	530pf/100mt
Max. capacity unbalance	1100 pf/100mt
standard impedance	100 ± 15 Ohm between 1Mhz and 250Mhz
Minimum bending radius	60mm
Working temperatures	-20 ~ 60°C

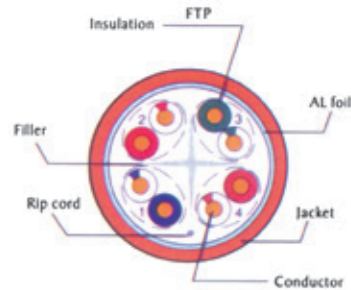

Frequency (Mhz)	Impedance (Ω)	RL (dB)	ATT (dB/100)	NEXT (dB)	PS-NEXT (dB)	ELFEXT (dB)	PS-ELFEXT (dB)
0.772Mhz	100 ± 15	19.44	1.84	76	74	70	67
1Mhz	100 ± 15	20	2.04	74.3	72.3	67.8	64.8
4Mhz	100 ± 15	23.01	3.81	65.3	63.3	55.8	52.8
8Mhz	100 ± 15	24.52	5.35	60.8	58.8	49.7	46.7
10Mhz	100 ± 15	25	5.99	59.3	57.3	47.8	44.8
16Mhz	100 ± 15	25	7.6	56.2	54.2	43.7	40.7
20Mhz	100 ± 15	25	8.52	54.8	52.8	41.8	38.8
25Mhz	100 ± 15	24.32	9.57	53.3	51.3	39.8	36.8
31.25Mhz	100 ± 15	23.64	10.74	51.9	49.9	37.9	34.9
62.5Mhz	100 ± 15	21.54	15.48	47.4	45.4	31.9	28.9
100Mhz	100 ± 15	20.1	19.92	44.3	42.3	27.8	24.8
125Mhz	100 ± 22	19.42	22.49	42.8	40.8	25.9	22.9
200Mhz	100 ± 22	18	29.15	39.8	37.8	21.8	18.8
250Mhz	100 ± 32	17.32	33.04	38.3	36.3	19.8	16.8

S/STP CATEGORY 6 LAN Cable

General Specification

Standard	Application
ISO/IEC 11801-2Ed	10/100BASE(TIEEE 802.3)
ANSI TIA/EIA 568-B.2-1	ATM,TP-PMD,ANSI X39T.5(TP),LSDN,TP-DDI
EN 50173	Ethernet,1000BASE-T
EN-50288-3-1	GIGABIT-Ethernet
	Token Ring (IEEE802.5)

Electrical Specification

Dielectric strength	2.5KV dc-2seconds
conductor resistance	Max 9.38Ohm/100mt at 20°C
Max. ring resistance	16.8 Ohm/100mt at 20°C
Max. mutual capacitance	560pf/100mt
Max. capacity unbalance	330 pf/100mt
standard impedance	100 ± 15 Ohm between 1Mhz and 250Mhz
Minimum bending radius	60mm
Working temperatures	-20 ~ 60°C

Frequency (Mhz)	Impedance (Ω)	RL/return loss (dB)	Attenuation (dB/100mt)	NEXT (dB)	PS-NEXT (dB)	EL-FEXT (dB)	PS-EL-FEXT (dB)
1Mhz	100 ± 15	20	1.9	80.3	77.3	70.8	67.8
10Mhz	100 ± 15	25	5.7	65.3	62.3	50.8	47.8
31.3Mhz	100 ± 15	25	10.2	57.9	54.9	40.9	37.9
62.5Mhz	100 ± 15	25	14.7	53.4	50.4	34.9	31.9
100Mhz	100 ± 15	25	18.9	50.3	47.3	30.8	27.8
155Mhz	100 ± 15	22.8	23.9	47.5	44.5	27	24
200Mhz	100 ± 15	21.7	27.5	45.8	42.8	24.7	21.7
250Mhz	100 ± 20	20.5	31.2	44.3	41.3	22.8	19.8



UTP CATEGORY 6A LAN Cable

General Specification

Standard	Application
ISO/IEC 11801-2Ed	10/100BASE(TIEEE 802.3)
ANSI TIA/EIA 568-B-2-1	ATM,TP-PMD,ANSI X39T.5(TP),LSDN,TP-DDI
EN 50173	Ethernet,1000BASE-T
EN-50288-3-1	GIGABIT-Ethernet Token Ring (IEEE802.5)

Electrical Specification

Dielectric strength	2.5KV dc-2seconds
conductor resistance	Max 9.38Ohm/100mt at 20°C
Max. ring resistance	16.8 Ohm/100mt at 20°C
Max. mutual capacitance	560pf/100mt
Max. capacity unbalance	330 pf/100mt
standard impedance	100 ± 15 Ohm between 1Mhz and 500Mhz
Minimum bending radius	60mm
Working temperatures	-20 ~ 60°C

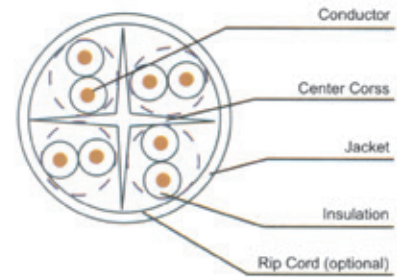

Frequency (Mhz)	Impedance (Ω)	RL/return loss(dB)	Attenuation (dB/100mt)	NEXT (dB)	PS-NEXT (dB)	EL-FEXT (dB)	PS EL-FEXT (dB)
0.772	--	--	1.8	79	77	73	69
1	100 ± 15	20	2	77	75	71	68
4	100 ± 15	23	3.8	68	66	59	56
8	100 ± 15	24.5	5.3	64	62	53	50
10	100 ± 15	25	6	62	60	51	48
16	100 ± 15	25	7.6	59	57	47	44
20	100 ± 15	25	8.5	58	56	45	42
25	100 ± 15	24.32	9.5	56	54	43	40
31.25	100 ± 15	23.64	10.7	55	53	41	38
62.5	100 ± 15	21.54	15.4	50	48	35	32
100	100 ± 15	20.1	19.8	47	45	31	28
155	100 ± 15	19.42	25.2	44	42	27	24
200	100 ± 15	18	29	43	41	25	22
250	100 ± 15	17.32	32.8	41	39	23	20
300	100 ± 15	16.8	36.4	40	38	21	18
350	100 ± 15	16.3	39.8	39	37	20	17
400	100 ± 15	15.9	43	38	36	19	16
450	100 ± 15	15.5	46	38	36	18	15
500	100 ± 15	15.2	48.9	37	35	17	14

S/STP CATEGORY 7 LAN Cable

General Specification

Standard	Application
ISO/IEC 11801-2Ed	10/100BASE(TIEEE 802.3)
ANSI TIA/EIA 568-B-2-1	ATM,TP-PMD,ANSI X39T.5(TP),LSDN,TP-DDI
EN 50173	Ethernet,1000BASE-T
EN-50288-3-1	GIGABIT-Ethernet Token Ring (IEEE802.5)

Electrical Specification

Dielectric strength	2.5KV dc-2seconds
conductor resistance	Max 9.38Ohm/100mt at 20°C
Max. ring resistance	16.8 Ohm/100mt at 20°C
Max. mutual capacitance	560pf/100mt
Max. capacity unbalance	330pf/100mt
standard impedance	100 ± 15 Ohm between 1Mhz and 600Mhz
Minimum bending radius	60mm
Working temperatures	-20 ~ 60°C

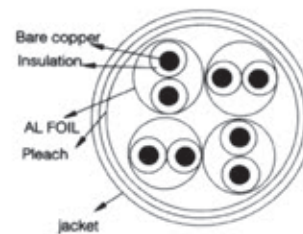

Frequency (Mhz)	RL/return loss (dB)	Attenuation (dB/100mt)	NEXT (dB)	PS-NEXT (dB)	PS-EL-FEXT (dB)
1MHz	/	2	80.3	99.4	/
10MHz	/	5.9	65.3	84.4	72.3
31.25MHz	23.6	10.4	57.9	77	62.4
62.5MHz	21.5	14.9	53.4	72.5	56.4
100MHz	20.1	19	50.3	69.4	52.3
155MHz	18.8	24	47.5	66.6	48.5
200MHz	18	27.5	45.8	64.9	46.3
250MHz	17.3	31	44.3	63.4	44.3
350MHz	16.3	37.2	40.2	61.2	41.4
400MHz	15.9	40	39.3	60.4	40.3
500MHz	15.2	45.3	37.8	58.9	38.3
550MHz	14.9	47.7	37.2	58.3	37.5
600MHz	14.7	50.1	36.6	57.7	36.7



LH02-1280



LH02-1281



LH02-1282



LH02-1283



LH02-1284



LH02-1285



LH02-1286



LH02-1287



LH02-1288

IN-WALL SPEAKER WIRE
A: AWG 12/2
B: AWG 14/2
C: AWG 16/2



LH02-1289

IN-WALL SPEAKER WIRE
A: AWG 14/4
B: AWG 16/4

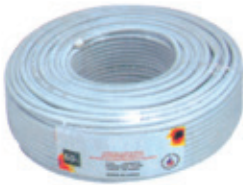

(1)



(2)



(3)



(4)



(5)

Specification list

No.	MODEL	SPEC	JACKET O.D.(mm)
1	10AWG	7X23/0.20	5.0X10.0
2	12AWG	105/0.20	4.0X8.0
3	14AWG	64/0.20	3.5X7.0
4	16AWG	65/0.16	3.0X6.0
5	18AWG	41/0.16	2.6X5.2
6	20AWG	26/0.16	2.4X4.8
7	22AWG	16/0.16	2.1X4.2
8	0.35MM	31/0.12	1.8X3.6
9	0.5MM	16/0.20	2.1X4.2
10	0.75MM	24/0.20	2.5X5.0
11	1.0MM	32/0.20	3.0X6.0
12	1.5MM	48/0.20	3.5X7.0
13	2.5MM	80/0.20	4.0X8.0

USB2.0 Cable

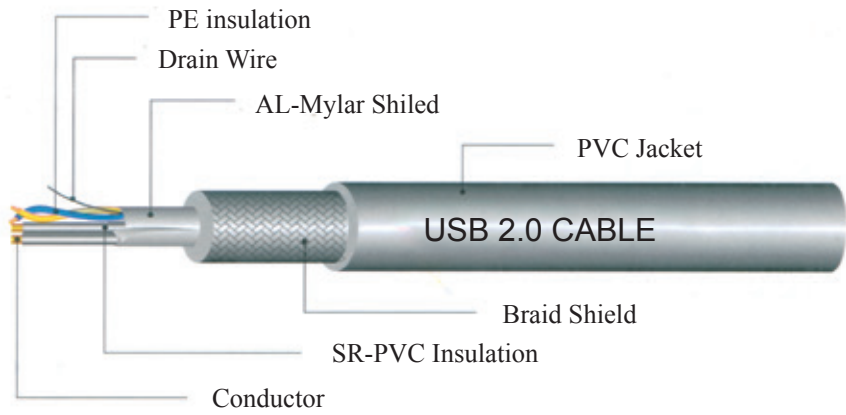

USB3.0 Cable

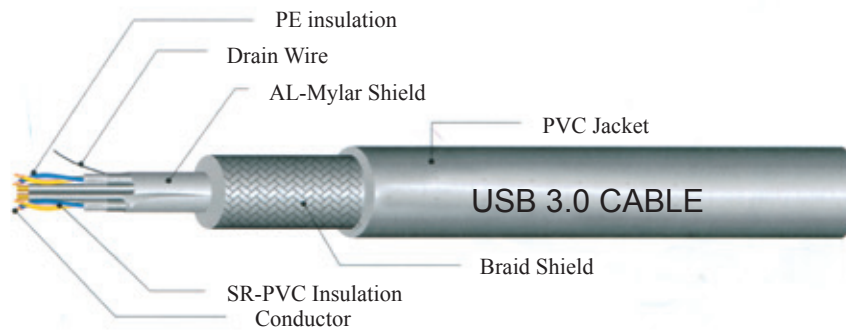

LH02-1290

USB CABLE A MALE-A MALE
3.0 VERSION



LH02-1293

USB CABLE A MALE-MICRO
B MALE
3.0 VERSION



LH02-1296

USB CABLE A MALE-B MALE
2.0 VERSION



LH02-1291

USB CABLE A MALE-A FEMALE
3.0 VERSION



LH02-1294

USB CABLE A MALE-A MALE
2.0 VERSION



LH02-1297

USB CABLE B MALE-B FEMALE
2.0 VERSION



LH02-1292

USB CABLE A MALE-B MALE
3.0 VERSION



LH02-1295

USB CABLE A MALE-A FEMALE
2.0 VERSION



LH02-1298

USB CABLE A MALE-B FEMALE
2.0 VERSION



LH02-1299

2.0 VERSION USB CABLE AM-MICRO
 USB 5P(FOR MOBILE)
 A:W/O CORE
 B:W/1 CORE
 C:W/2 CORES



LH02-1305

2.0 VERSION USB CABLE
 USB AM-MINI USB 4P-C TYPE(FOR
 CASIO, PANASONIC, TOSHIBA, KONICA)
 A: W/O CORE
 B: W/1 CORE
 C: W/2 CORES



LH02-1311

2.0 VERSION USB CABLE
 USB AM TO USB AM+AM



LH02-1300

2.0 VERSION USB CABLE, USB AM-
 RIGHT ANGLE MICRO USB 5P
 (FOR MOBILE)
 A:W/O CORE
 B:W/1 CORE
 C:W/2 CORES



LH02-1306

2.0 VERSION USB CABLE
 USB A MALE TO USB MINI\ 5PIN+DC PLUG



LH02-1312

2.0 VERSION USB CABLE
 USB AM TO USB AM+MINI 5P



LH02-1301

2.0 VERSION USB CABLE
 USB AM-MINI USB 5P TYPE
 A:W/O CORE
 B:W/1 CORE
 C:W/2 CORES



LH02-1307

2.0 VERSION USB CABLE
 USB AM MINI USB 8P ROUND TYPE
 A: W/O CORE
 B: W/1 CORE
 C: W/2 CORES



LH02-1313

2.0 VERSION USB CABLE
 USB AM TO 3.5MM 4C PLUG
 A: W/ CORE
 B: W/O CORE



LH02-1302

2.0 VERSION USB CABLE
 USB AF-MINI USB 5P TYPE
 A:W/O CORE
 B:W/1 CORE
 C:W/2 CORES



LH02-1308

2.0 VERSION USB CABLE
 USB AM MINI USB 8P FLAT TYPE
 A: W/O CORE
 B: W/1 CORE
 C: W/2 CORES



LH02-1314

2.0 VERSION USB CABLE
 USB AM TO DC 3.5X1.35MM PLUG



LH02-1303

2.0 VERSION USB CABLE
 USB AM-MINI USB 4P-A TYPE
 A:W/O CORE
 B:W/1 CORE
 C:W/2 CORES



LH02-1309

2.0 VERSION USB CABLE
 MINI USB 8P FLAT TYPE-2 RCA
 A: W/O CORE
 B: W/1 CORE



LH02-1315

2.0 VERSION USB CABLE
 USB A MALE TO 2 RCA PLUG



LH02-1304

2.0 VERSION USB CABLE
 USB AM-MINI USB 4P-B TYPE
 A:W/O CORE
 B:W/1 CORE
 C:W/2 CORES



LH02-1310

2.0 VERSION USB CABLE
 MINI USB 8PIN TO 3 RCA PLUG



LH02-1316

2.0 VERSION USB CABLE
 USB A MALE TO 3 RCA PLUG



LH02-1317

USB 2.0 AM-AM, CLEAR CABLE

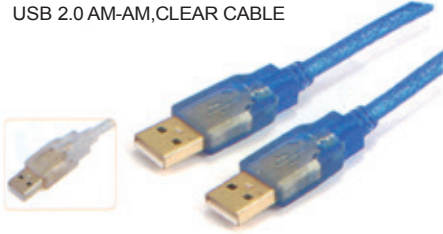
**LH02-1322**
 USB 3.0 A FEMALE
 TO A FEMALE
 ADAPTOR
 A: GOLD
 B: NICKEL
**LH02-1328**
 USB 3.0 A FEMALE
 TO MICRO MALE
 ADAPTOR
 A:GOLD
 B:NICKEL
**LH02-1318**

USB 2.0 AM-AF, CLEAR CABLE

**LH02-1323**
 USB 3.0 A FEMALE
 TO A MALE
 ADAPTOR
 A: GOLD
 B: NICKEL
**LH02-1329**
 USB 3.0 A MALE
 TO MICRO MALE
 ADAPTOR
 A:GOLD
 B:NICKEL
**LH02-1319**

USB 2.0 AM-BM, CLEAR CABLE

**LH02-1324**
 USB 3.0 A MALE
 TO A FEMALE
 ADAPTOR
 A: GOLD
 B: NICKEL
**LH02-1330**
 USB 3.0 A FEMALE
 TO A FEMALE
 ADAPTOR
 A:GOLD
 B:NICKEL
**LH02-1320**

USB 2.0 EXTENSION CABLE

**LH02-1325**
 USB 3.0 A MALE
 TO A FEMALE
 ADAPTOR
 90 ANGLE TYPE
 A: GOLD
 B: NICKEL
**LH02-1331**
 USB 2.0 A FEMALE
 TO A MALE
 ADAPTOR
 A:GOLD
 B:NICKEL
**LH02-1321**
 2.0 VERSION USB CABLE
 A MALE-A FEMALE
 WITH SCREW
**LH02-1326**
 USB 3.0 A MALE
 TO B MALE
 ADAPTOR
 A:GOLD
 B:NICKEL
**LH02-1332**
 USB 2.0 A MALE
 TO A MALE
 ADAPTOR
 A:GOLD
 B:NICKEL
**LH02-1327**
 USB 3.0 A FEMALE
 TO B MALE
 ADAPTOR
 A:GOLD
 B:NICKEL
**LH02-1333**
 USB 2.0 A MALE TO
 MINI 5PIN MALE
 ADAPTOR
 A:GOLD
 B:NICKEL



LH02-1334

USB 2.0 MICRO 5PIN MALE
TO MINI 5PIN FEMALE
ADAPTOR
A:GOLD
B:NICKEL

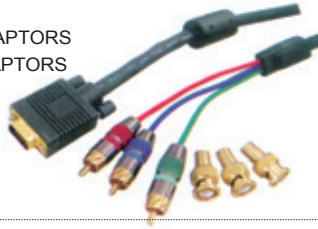

LH02-1340

HDTV CABLE
VGA 15PIN MALE TO 3 RCA PLUG
CABLE
A: W/O ADAPTORS
B: W/3 ADAPTORS



LH02-1346

VGA MALE TO 2XVGA FEMALE



LH02-1335

USB 2.0 A FEMALE TO
MICRO 5PIN MALE
ADAPTOR
A:GOLD
B:NICKEL



LH02-1341

VGA 15 PIN MALE TO
3 RCA PLUG



LH02-1347

VGA PLUG TO 2 x VGA JACKS

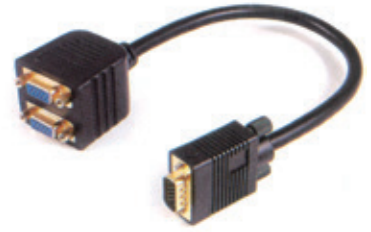

LH02-1336

USB 2.0 A MALE
TO B MALE
ADAPTOR
A:GOLD
B:NICKEL



LH02-1342

VGA 15 PIN MALE TO MINI 4PF+RCA JACK



LH02-1348

SERIAL CABLE DB9-DB9
A: M-M
B: M-F
C: F-F



LH02-1337

USB 2.0 A FEMALE
TO B MALE
ADAPTOR
A:GOLD
B:NICKEL



LH02-1343

A:HDB 15M+2 MINI 6P(M) TO HDB 15F+2MINI 6P(M)
B:HDB 15M+2 MINI 6P(M) TO HDB 15M+2MINI 6P(M)



LH02-1349

MONITOR CABLE
HDD15P-HDD15P
A: M-M
B: M-F



LH02-1338

USB AF-PS/2 M



LH02-1344

HDTV CABLE
VGA 15PIN MALE TO 5
BNC CABLE
A: W/O ADAPTORS
B: W/5 ADAPTORS



LH02-1350

USB TO PS/2 KEYBOARD/MOUSE
ADAPTER CABLE



LH02-1339

USB AM-PS/2 F



LH02-1345

RS232 CABLE



LH02-1351

HD15 F/F VGA GENDER
CHANGER (COUPLER)

**LH02-1357**

DVI MALE TO HD15 VGA FEMALE
VIDEO ADAPTER

**LH02-1363**

DB9 ADAPTOR
A:DB 9M/M
B:DB 9M/F
C:DB 9F/F

**LH02-1352**

HD15 M/M VGA GENDER CHANGER
(COUPLER)

**LH02-1358**

DVI FEMALE TO HD15 VGA MALE
VIDEO ADAPTER

**LH02-1364**

D-SUB SOLDER TYPE-MALE
A:9PIN
B:15PIN
C:25PIN
D:37PIN
E:50PIN
F:HDD 15PIN

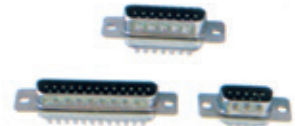
**LH02-1353**

HD15 VGA M/F PORT SAVER ADAPTER

**LH02-1359**

MOUSE ADAPTOR
A: MINI DIN 6M/DB 9M
B: MINI DIN 6F/DB 9F

**LH02-1365**

D-SUB SOLDER TYPE-FEMALE
A:9PIN
B:15PIN
C:25PIN
D:37PIN
E:50PIN
F:HDD 15PIN

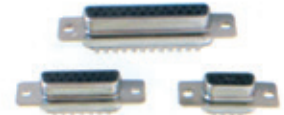
**LH02-1354**

DB15 MALE TO VGA HD15 FEMALE ADAPTER

**LH02-1360**

MINI GENDER CHANGER
A: 9M-9M
B:9F-9F
C:9M-9F

**LH02-1366**

D-SUB DIP TYPE
A:9PIN MALE
B:9PIN FEMALE
C:15PIN MALE
D:15PIN FEMALE
E:25PIN MALE
F:25PIN FEMALE
A:HD 15P MALE
H:HD 15P FEMALE

**LH02-1355**

VGA HD15 MALE TO DB9 FEMALE ADAPTER

**LH02-1361**

MINI GENDER CHANGER
A: HDD 15M-HDB 15M
B: HDD 15F-HDB 15F
C: HDD 15M-HDB 15F

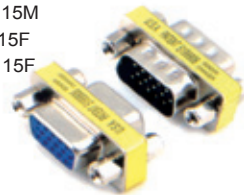
**LH02-1367**

D-SUB HOOD KIT WITH SHORT SCREWS
A: 9PIN
B: 15PIN
C: 25PIN
D: 37PIN
E: 50PIN

**LH02-1356**

VGA HD15 FEMALE TO DB9 MALE ADAPTER

**LH02-1362**

D-SUB ADAPTOR
A: DB9 M/DB25 M
B: DB9 M/DB25 F
C: DB9 F/DB25 M
D: DB9 F/DB25 F

**LH02-1368**

D-SUB HOOD KIT WITH LONG SCREWS
A: 9 PIN
B: 15PIN
C: 25PIN
D: 37PIN
E: 50PIN



LH02-1369

2PIN ROUND PLUG TO
3PIN FLAT JACK
(EUROPEAN TYPE)



LH02-1370

2PIN ROUND PLUG TO
3PIN FLAT JACK
ANGLE TYPE
(EUROPEAN TYPE)



LH02-1371

3PIN FLAT PLUG TO
3PIN FLAT JACK
(AUSTRALIAN TYPE)



LH02-1372

3PIN FLAT PLUG TO 3PIN
FLAT JACK, ANGLE TYPE
(AUSTRALIAN TYPE)



LH02-1373

3PIN ROUND PLUG TO
3PIN FLAT JACK
(ITALIAN TYPE)

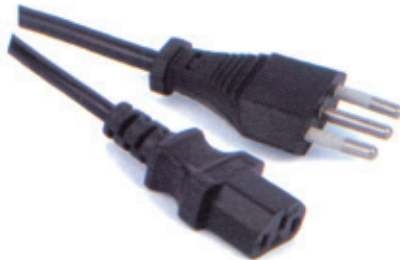

LH02-1374

3PIN ROUND PLUG TO 3PIN
FLAT JACK, ANGLE TYPE
(ITALIAN TYPE)



LH02-1375

3PIN ROUND PLUG TO 3PIN
FLAT JACK
(SWISS TYPE)

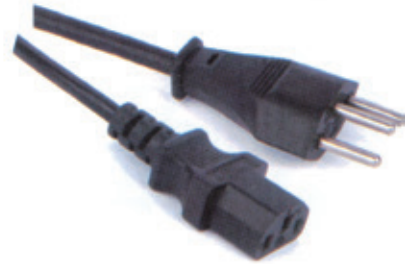

LH02-1376

3PIN ROUND PLUG TO 3PIN
FLAT JACK, ANGLE TYPE
(SWISS TYPE)



LH02-1377

3PIN PLUG TO 3PIN JACK
(AMERICAN/CANADIAN TYPE)

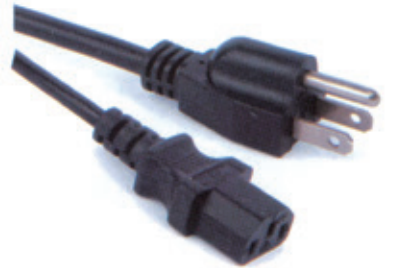

LH02-1378

3PIN PLUG TO 3PIN JACK
(AMERICAN/CANADIAN TYPE)



LH02-1379

3PIN ROUND PLUG TO
3PIN FLAT JACK
(SOUTH AFRICAN
TYPE)



LH02-1380

3PIN ROUND PLUG TO
3PIN FLAT JACK
(SOUTH AFRICAN
TYPE)



LH02-1381

3PIN FLAT PLUG TO 3PIN FLAT JACK,(BRITISH TYPE)



LH02-1385

2PIN ROUND PLUG TO 2P ROUND JACK, (BRAZILIAN TYPE)

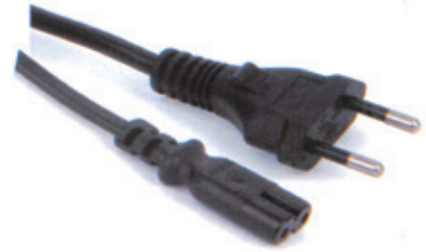

LH02-1382

3PIN FLAT PLUG TO 3PIN FLAT JACK ANGLE TYPE (BRITISH TYPE)



LH02-1386

2PIN ROUND PLUG TO 2PIN ROUND JACK (EUROPEAN TYPE)



LH02-1383

3PIN ROUND PLUG TO 3PIN FLAT JACK (ISRAELI TYPE)



LH02-1387

2PIN ROUND PLUG TO 2PIN ROUND JACK (ITALIAN/SWISS TYPE)



LH02-1384

3PIN ROUND PLUG TO 3PIN FLAT JACK, ANGLE TYPE (ISRAELI TYPE)



LH02-1388

2PIN PLUG TO 2PIN JACK (AMERICAN TYPE)

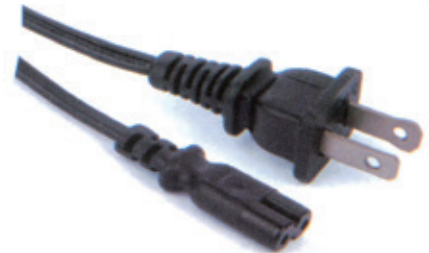

WORLDWIDE PLUG INFORMATION

Configuration Code	A	B	C	D	E
Configuration Diagram					
Type of power Supply	China U.S.A Japan	U.S.A	Europe	Europe	Europe
Configuration Code	F	G	H	I	J
Configuration Diagram					
Type of power Supply	Denmark	Switzerland	Italy	Britain	Britain
Configuration Code	K	L	M		
Configuration Diagram					
Type of power Supply	Australia	Australia	Israel		

This chart presents an overview of power supply systems throughout the world. The configurations listed for the electrical systems of industrialized countries are accurate and reliable.

LH02-1389

- TRAVEL ADAPTER PLUG
- AVAILABLE FOR IPHONE/IPAD
- APPLY TO ASIA/EUROPE/AMERICA/AUS-TRALIA/MIDDLE EAST

COLOURS: ●●●●●●●●



LH02-1390

- UNIVERSAL TRAVEL ADAPTER PLUG
- EASY TO USE AND CARRY
- APPLY TO ASIA/EUROPE/AMERICA/AUS-TRALIA/MIDDLE EAST

COLOURS: ●●●●●●●●

LH02-1391

- UNIVERSAL TRAVEL ADAPTER PLUG
- EASY TO USE AND CARRY
- APPLY TO ASIA/EUROPE/AMERICA/AUS-TRALIA/MIDDLE EAST

COLOURS: ●●●●●●●●



LH02-1392

- TRAVEL ADAPTER PLUG
- SMART DESIGN CAN HELP CONVERT TO DIFFERENT PLUG STANDARD RIGHT NOW
- EASY TO USE AND PORTABILITY
- APPLY TO ASIA/EUROPE /AMERICA/AUSTRALIA/MIDDLE EAST

COLOURS: ●●●●●●●●





LH02-1393

- UNIVERSAL TRAVEL ADAPTER PLUG
- SWISS CLASSICAL DESIGN, POPULAR GIFTS
- APPLY TO ASIA /EUORPE/AMERICA/AUSTRALIA/MIDDLE EAST

COLOURS: ●●●●●●●●



LH02-1394

- TRAVEL ADAPTER PLUG
- USB IS AVAILABLE FOR IPHONE/MOBILE PHONE/MP3/MP4
- APPLY TO ASIA/EUORPE /AMERICA /AUSTRALIA /MIDDLE EAST

COLOURS: ●●●●●●●●



LH02-1395

- TRAVEL ADAPTER PLUG
- USB IS AVAILABLE FOR IPHONE/MOBILE PHONE/MP3/MP4
- APPLY TO ASIA /EUORPE/AMERICA/AUSTRALIA/MIDDLE EAST

COLOURS: ●●●●●●●●

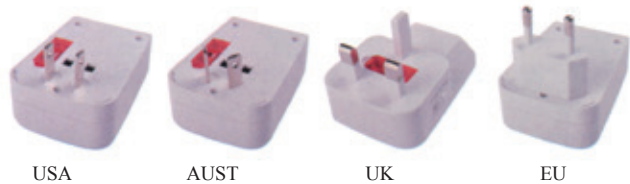

LH02-1396

- TRAVEL ADAPTER PLUG
- 2 USB+4 PLUG POWER ADAPTER
- FIT FOR IPHONE IPAD
- APPLY TO ASIA /EUORPE/AMERICA/AUSTRALIA/MIDDLE EAST

COLOURS: ●●●●●●●●





LH02-1397

- UNIVERSAL TRAVEL ADAPTER PLUG
- SWISS CLASSICAL DESIGN, POPULAR GIFTS
- APPLY TO ASIA /EUORPE/AMERICA/AUSTRALIA/MIDDLE EAST

COLOURS: ●●●●●●●●

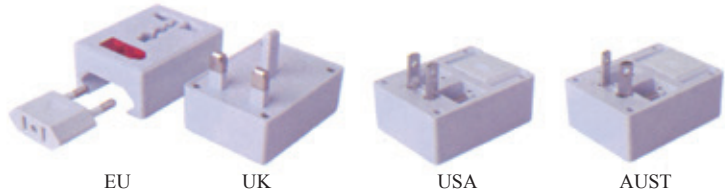

LH02-1398

- TRAVLE ADAPTER PLUG
- APPLY TO ASIA /EUORPE/AMERICA/AUSTRALIA/ MIDDLE EAST

COLOURS: ●●●●●●●●



LH02-1399



LH02-1400



LH02-1401



LH02-1402



LH02-1403



LH02-1404



LH02-1405
3P AC POWER PLUG



LH02-1411
2P FLAT AC PLUG TO
2P AC JACK

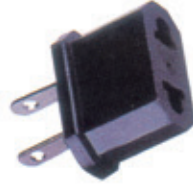

LH02-1417
3P AC PLUG TO MULTI-
PURPOSE JACK



LH02-1423



LH02-1406
3P AC POWER JACK



LH02-1412
2P FLAT AC PLUG TO
3 x AC JACK



LH02-1418
AC ROUND
PLUG 4MM TO BRITAIN AC
FEMALE



LH02-1424

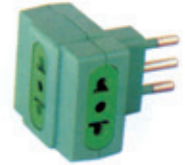

LH02-1407
3P AC POWER PLUG



LH02-1413
AC POWER PLUG ADAPTER



LH02-1419
4.8MM EUROPE
STYLE ROUND PLUG TO
USEFUL AC
FEMALE PLUG



LH02-1425

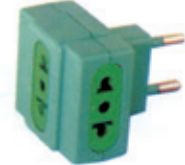

LH02-1408
3P AC POWER JACK



LH02-1414
2P AC FLAT PLUG
TO MULTI-PUR
POSE JACK



LH02-1420



LH02-1426



LH02-1409
2P ROUND AC PLUG TO
2P FLAT AC JACK



LH02-1415
3P AC FLAT PLUG
TO MULTI-PURPOSE
JACK



LH02-1421



LH02-1427



LH02-1410
2P FLAT AC PLUG TO
2P AC JACK



LH02-1416
2P AC ROUND PLUG TO
MULTI-PURPOSE
JACK



LH02-1422



LH02-1428

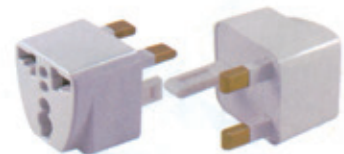

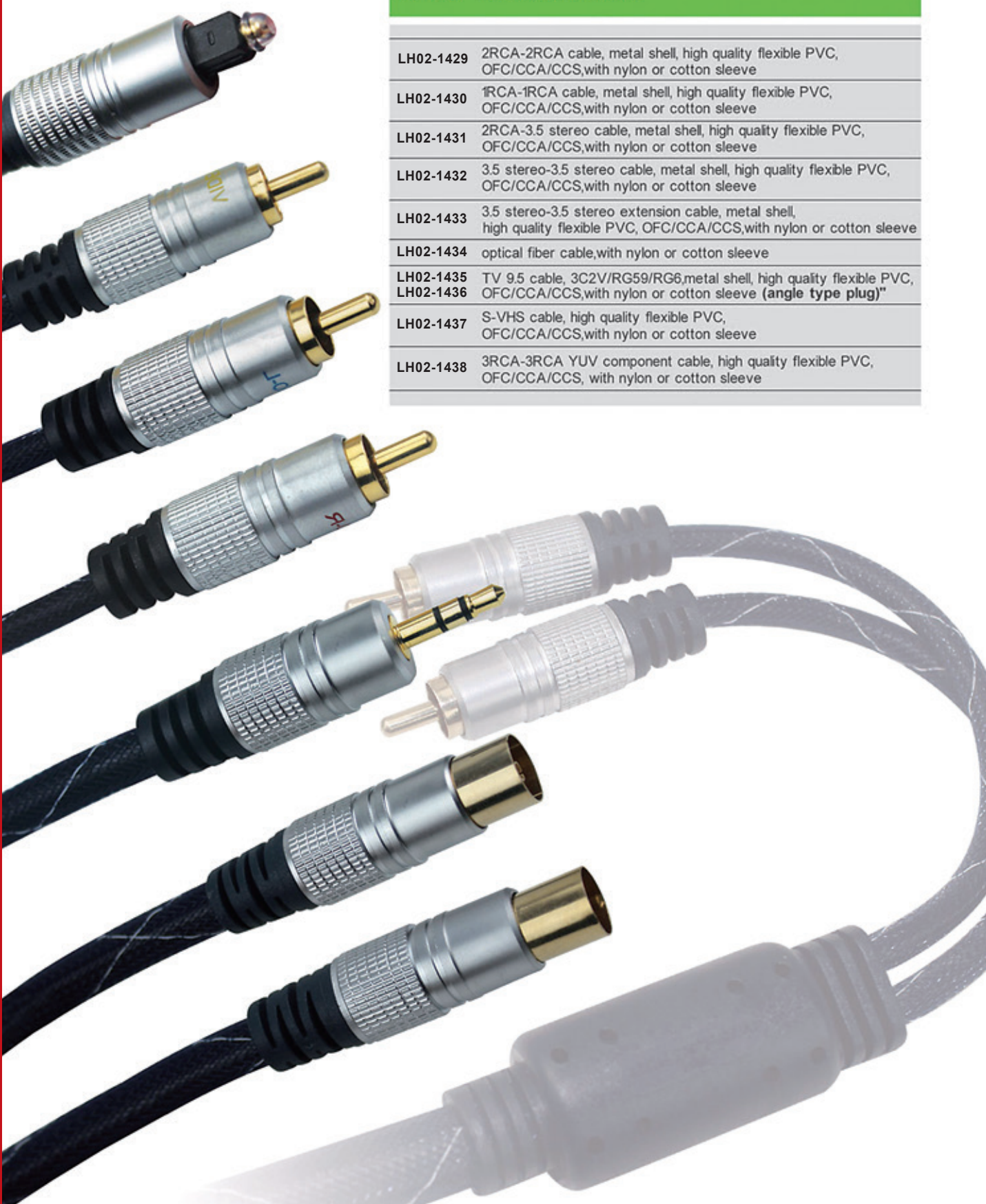

Item NO.	Product Description
LH02-1429	2RCA-2RCA cable, metal shell, high quality flexible PVC, OFC/CCA/CCS,with nylon or cotton sleeve
LH02-1430	1RCA-1RCA cable, metal shell, high quality flexible PVC, OFC/CCA/CCS,with nylon or cotton sleeve
LH02-1431	2RCA-3.5 stereo cable, metal shell, high quality flexible PVC, OFC/CCA/CCS,with nylon or cotton sleeve
LH02-1432	3.5 stereo-3.5 stereo cable, metal shell, high quality flexible PVC, OFC/CCA/CCS,with nylon or cotton sleeve
LH02-1433	3.5 stereo-3.5 stereo extension cable, metal shell, high quality flexible PVC, OFC/CCA/CCS,with nylon or cotton sleeve
LH02-1434	optical fiber cable,with nylon or cotton sleeve
LH02-1435 LH02-1436	TV 9.5 cable, 3C2V/RG59/RG6,metal shell, high quality flexible PVC, OFC/CCA/CCS,with nylon or cotton sleeve (angle type plug)"
LH02-1437	S-VHS cable, high quality flexible PVC, OFC/CCA/CCS,with nylon or cotton sleeve
LH02-1438	3RCA-3RCA YUV component cable, high quality flexible PVC, OFC/CCA/CCS, with nylon or cotton sleeve



Item NO. Product Description

LH02-1439	TV 9.5 cable, 3C2V/RG59/RG6, metal shell, high quality flexible PVC, OFC/CCA/CCS, with nylon or cotton sleeve (angle type plug)
LH02-1440	2RCA-2RCA cable, metal shell, high quality flexible PVC, OFC/CCA/CCS,with nylon or cotton sleeve
LH02-1441	1RCA-1RCA cable, metal shell, high quality flexible PVC, OFC/CCA/CCS,with nylon or cotton sleeve
LH02-1442	2RCA-3.5 stereo cable, metal shell, high quality flexible PVC, OFC/CCA/CCS,with nylon or cotton sleeve
LH02-1443	3.5 stereo-3.5 stereo cable, metal shell, high quality flexible PVC, OFC/CCA/CCS,with nylon or cotton sleeve
LH02-1444	3.5 stereo-3.5 stereo extension cable, metal shell, high quality flexible PVC, OFC/CCA/CCS,with nylon or cotton sleeve
LH02-1445	optical fiber cable,with nylon or cotton sleeve
LH02-1446	F plug cable, 3C2V/RG59/RG6,metal shell, high quality flexible PVC, OFC/CCA/CCS,with nylon or cotton sleeve (angle type plug)
LH02-1447	3RCA-3RCA YUV component cable, high quality flexible PVC, OFC/CCA/CCS, with nylon or cotton sleeve
LH02-1448	
LH02-1449	



Item NO.	Product Description
LH02-1450	3RCA-3RCA Composite cable, high quality flexible PVC, OFC/CCA/CCS
LH02-1451	3RCA-3RCA YUV component cable, high quality flexible PVC, OFC/CCA/CCS
LH02-1452	2RCA-2RCA cable, high quality flexible PVC, OFC/CCA/CCS
LH02-1453	1RCA-1RCA cable, high quality flexible PVC, OFC/CCA/CCS
LH02-1454	2RCA-3.5 stereo cable, high quality flexible PVC, OFC/CCA/CCS
LH02-1455	3RCA-3.5 stereo cable, high quality flexible PVC, OFC/CCA/CCS
LH02-1456	3.5 stereo-3.5 stereo cable, high quality flexible PVC, OFC/CCA/CCS
LH02-1457	3.5 stereo-3.5 stereo extension cable, high quality flexible PVC, OFC/CCA/CCS
LH02-1458	3.5 stereo-2 x 3.5 stereo female cable, 20cm, high quality flexible PVC, OFC/CCA/CCS
LH02-1459	HDMI-HDMI cable, high quality flexible PVC, OFC/CCA/CCS

Blister packing:



Item NO.	Product Description
----------	---------------------

LH02-1460	3RCA-3RCA Composite cable, high quality flexible PVC, OFC/CCA/CCS
LH02-1461	3RCA-3RCA YUV component cable, high quality flexible PVC, OFC/CCA/CCS
LH02-1462	2RCA-2RCA cable, high quality flexible PVC, OFC/CCA/CCS
LH02-1463	2RCA-3.5 stereo cable, high quality flexible PVC, OFC/CCA/CCS
LH02-1464	3RCA-3.5 stereo cable, high quality flexible PVC, OFC/CCA/CCS
LH02-1465	3.5 stereo-3.5 stereo cable, high quality flexible PVC, OFC/CCA/CCS
LH02-1466	3.5 stereo-3.5 stereo extension cable, high quality flexible PVC, OFC/CCA/CCS

LH02-1467	3RCA-3RCA Composite cable, high quality flexible PVC, OFC/CCA/CCS
LH02-1468	3RCA-3RCA YUV component cable, high quality flexible PVC, OFC/CCA/CCS
LH02-1469	2RCA-2RCA cable, high quality flexible PVC, OFC/CCA/CCS
LH02-1470	2RCA-3.5 stereo cable, high quality flexible PVC, OFC/CCA/CCS
LH02-1471	3.5 stereo-3.5 stereo cable, high quality flexible PVC, OFC/CCA/CCS
LH02-1472	3.5 stereo-3.5 stereo extension cable, high quality flexible PVC, OFC/CCA/CCS
LH02-1473	9.5TV male - male cable, high quality flexible PVC, OFC/CCA/CCS
LH02-1474	9.5TV male - female cable, high quality flexible PVC, OFC/CCA/CCS



LH02-1475

RCA PLUG TO RCA PLUG



LH02-1481

RCA PLUG TO RCA PLUG



LH02-1487

RCA PLUG TO RCA PLUG



LH02-1476

RCA PLUG TO RCA JACK



LH02-1482

RCA PLUG TO RCA JACK



LH02-1488

2RCA PLUG TO 2RCA PLUG



LH02-1477

2RCA PLUG TO 2RCA PLUG



LH02-1483

2RCA PLUG TO 2RCA PLUG



LH02-1489

3RCA PLUG TO 3RCA PLUG



LH02-1478

2RCA PLUG TO 2RCA JACKS



LH02-1484

2RCA PLUG TO 2RCA JACKS



LH02-1490

2RCA PLUG AND S-VHS PLUG TO 2
RCA PLUG AND
S-VHS PLUG



LH02-1479

3RCA PLUG TO 3RCA PLUG



LH02-1485

3RCA PLUG TO 3RCA PLUG



LH02-1491

S-VHS PLUG TO S-VHS PLUG



LH02-1480

3RCA PLUG TO 3RCA JACKS



LH02-1486

3RCA PLUG TO 3RCA JACKS



LH02-1492

3.5MM STEREO PLUG TO
2 RCA PLUG



LH02-1493

3.5MM STEREO PLUG TO
3.5MM STEREO PLUG



LH02-1499

1 RCA PLUG TO 1 RCA PLUG,
DOUBLE COLOR,FLAT CABLE



LH02-1505

"Y"RCA CABLE
O.D.3.8x7.6MM,
CLEAR CABLE



LH02-1494

3.5MM STEREO PLUG TO
3.5MM STEREO JACK



LH02-1500

2RCA PLUG TO 2 RCA PLUG,
DOUBLE COLOR,FLAT CABLE



LH02-1506

2 RCA PLUG TO 2 RCA PLUG
CLEAR CABLE

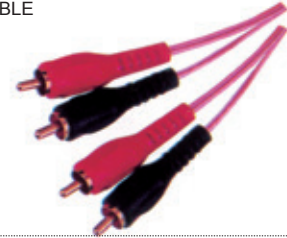

LH02-1495

3.5MM STEREO PLUG TO
2x3.5 STEREO JACKS
OD 3x6MM



LH02-1501

3 RCA PLUG TO 3 RCA PLUG,
DOUBLE COLOR,FLAT CABLE



LH02-1507

3 RCA PLUG TO 3 RCA PLUG,
CLEAR CABLE

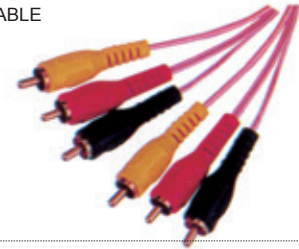

LH02-1496

3 RCA PLUG TO 3 RCA PLUG,
O.D.: 3.2MM x 9.6MM



LH02-1502

3.5MM STEREO PLUG TO
3.5MM STEREO JACK,
DOUBLE COLOR,FLAT
CABLE



LH02-1508

3 RCA PLUG TO 3 RCA PLUG,
O.D.: 3+6+3MM



LH02-1497

3.5MM STEREO PLUG TO 2 RCA PLUG,
O.D.: 3.2MM x 6.4MM



LH02-1503

3.5MM STEREO PLUG TO
3.5MM STEREO PLUG,
DOUBLE COLOR,FLAT
CABLE



LH02-1509

COMPONENT AUDIO/VIDEO CABLE (1VIDEO+2-
AUDIO) MOULDED 3RCA PLUG TO
3RCA PLUG
O.D.: 3.7 x 11.1MM

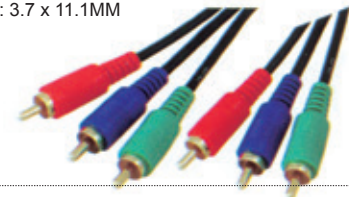

LH02-1498

3.5MM 4C PLUG TO 3 RCA PLUG,
O.D.: 3.2MM x 9.6MM



LH02-1504

S-VHS PLUG TO
S-VHS PLUG,
DOUBLE COLOR,
FLAT CABLE



LH02-1510

COMPONENT AUDIO/VIDEO CABLE (1VIDEO+2-
AUDIO) MOULDED 3RCA PLUG TO 3RCA
PLUG,CLEAR CABLE
O.D.: 3.7 x 11.1MM



LH02-1511

COMPOSITE
CABLE, TRANSPARENT TYPE



LH02-1512

COMPONENT
CABLE, TRANSPARENT TYPE



LH02-1513

COMPONENT AUDIO/VIDEO CABLE
(1-VIDEO+2-AUDIO) MOULDED 3RCA PLUG
TO 3RCA PLUG
O.D.: 6.0MM x 3C



LH02-1514

COMPONENT AUDIO/VIDEO CABLE (3-
(1-VIDEO+2-AUDIO) MOULDED 5RCA PLUG
TO 5RCA PLUG
O.D.: 6.0MM x 5C



LH02-1515

A. Y CABLE, RCA JACK TO 2xRCA PLUG,
W/O CABLE LOCK
B. Y CABLE, RCA PLUG
TO 2xRCA JACKS,
WO CABLE LOCK



LH02-1516

1RCA PLUG TO 1RCA PLUG
METAL PLUG



LH02-1517

2RCA PLUG TO 2RCA PLUG
METAL PLUG



LH02-1518

2RCA PLUG TO 2RCA JACK
METAL PLUG



LH02-1519

2RCA PLUG TO 3RCA PLUG
METAL PLUG



LH02-1520

3.5MM STEREO PLUG TO
3.5 STEREO PLUG
METAL PLUG



LH02-1521

3.5MM STEREO PLUG TO
3.5 STEREO JACK
METAL PLUG



LH02-1522

3.5MM STEREO PLUG TO
2x3.5 STEREO JACKS
METAL PLUG



LH02-1523

3.5MM STEREO PLUG TO
2xRCA PLUG



LH02-1524

9.5MM PLUG TO 9.5MM PLUG
METAL PLUG



LH02-1525

9.5MM PLUG TO 9.5MM JACK
METAL PLUG



LH02-1526

1 RCA PLUG TO 1 RCA PLUG, GOLD
PLATED, METAL PLUG



LH02-1527

2 RCA PLUG TO 2 RCA PLUG,
GOLD PLATED, METAL PLUG



LH02-1528

3 RCA PLUG TO 3 RCA PLUG,
GOLD PLATED, METAL PLUG

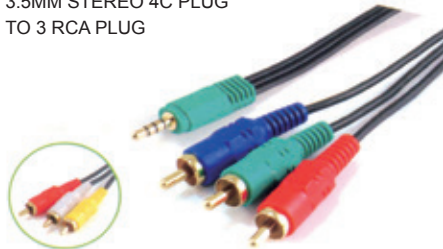
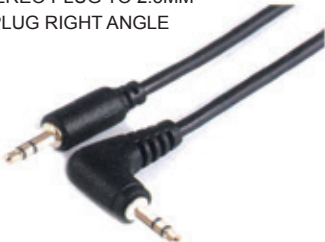
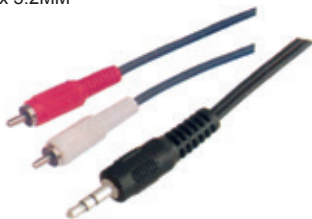

LH02-1529S-VHS PLUG TO S-VHS PLUG,
GOLD PLATED,METAL PLUG**LH02-1535**2.5MM STEREO PLUG TO 2
RCA PLUG**LH02-1541**3.5MM STEREO PLUG RIGHT
ANGLE TO 3.5MM STEREO JACK**LH02-1530**3.5MM STEREO PLUG TO 3.5MM
STEREO PLUG RIGHT ANGLE
WITH MESH JACKET**LH02-1536**3.5MM STEREO PLUG
TO 2 RCA JACKS**LH02-1542**3.5MM STEREO PLUG TO
3.5MM STEREO JACK,
O.D.:2.6 x 5.2MM**LH02-1531**2.5MM STEREO PLUG RIGHT
ANGLE TO 3.5MM STEREO JACK**LH02-1537**3.5MM STEREO 4C PLUG
TO 3 RCA PLUG**LH02-1543**3.5MM STEREO PLUG TO
3.5MM STEREO PLUG,
FLAT CABLE
O.D.:2.6 x 5.2MM**LH02-1532**2.5MM STEREO PLUG TO 2.5MM
STEREO PLUG RIGHT ANGLE**LH02-1538**3.5MM STEREO 4C PLUG
TO 3 RCA JACKS**LH02-1544**3.5MM STEREO PLUG TO
3.5MM STEREO PLUG,
ROUND CABLE
O.D.:4MM**LH02-1533**3.5MM STEREO PLUG TO 2 RCA PLUG,
O.D.: 2.6MM x 5.2MM**LH02-1539**3.5MM STEREO PLUG RIGHT ANGLE
TO 2 RCA PLUG**LH02-1545**3.5MM STEREO 4C PLUG TO
3.5MM STEREO 4C PLUG,
ROUND CABLE
O.D.: 4MM**LH02-1534**3.5MM STEREO PLUG TO
DIN 5P PLUG**LH02-1540**3.5MM STEREO PLUG
TO 6.35MM STEREOJACK**LH02-1546**3.5MM STEREO PLUG TO 3.5MM STEREO
RIGHT ANGLE PLUG,FLAT CABLE
O.D.: 2.6 x 5.2MM

LH02-1547

3.5MM STEREO RIGHT ANGLE PLUG TO 3.5MM STEREO RIGHT ANGLE PLUG, FLAT CABLE
O.D.:2.6 x 5.2MM



LH02-1553

6.35MM STEREO PLUG TO 2 RCA PLUG



LH02-1559

S-VHS PLUG TO RCA PLUG



LH02-1548

6.35MM STEREO PLUG TO 3.5MM STEREO PLUG,ROUND CABLE
O.D.:4MM



LH02-1554

2 x 6.35MM MONO PLUG TO 6.35MM MONO JACK



LH02-1560

MINI DIN 9 PIN TO 3 RCA CABLE

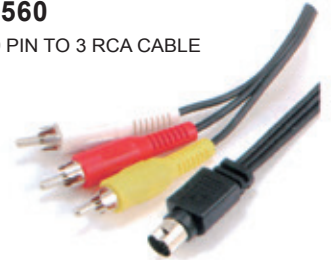

LH02-1549

3.5MM STEREO PLUG TO 2x 6.35MM MONO PLUG,FLAT CABLE
O.D.: 2.6MM x 5.2MM



LH02-1555

6.35MM STEREO PLUG TO 6.35MM STEREO PLUG



LH02-1561

MINI DIN 10 PIN TO 3 RCA CABLE

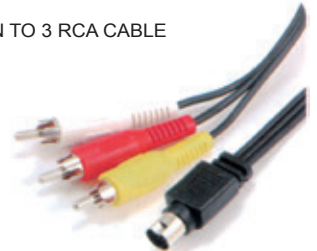

LH02-1550

3.5MM STEREO PLUG TO 3.5MM STEREO JACK,COIL CABLE



LH02-1556

6.5MM STEREO PLUG TO 6.5MM STEREO JACK



LH02-1562

A:9.5MM TV PLUG TO 9.5MM TV PLUG
B:9.5MM TV PLUG TO 9.5MM TV JACK



LH02-1551

3.5MM STEREO 4C+2.5MM STEREO 4C TO 5RCA JACK



LH02-1557

6.35MM STEREO PLUG TO 6.35MM STEREO JACK,COIL CABLE



LH02-1563

A:9.5MM TV PLUG TO 9.5MM TV PLUG
B:9.5MM TV PLUG TO 9.5MM TV JACK



LH02-1552

6.35MM STEREO PLUG TO 2 RCA JACKS



LH02-1558

S-VHS PLUG TO-VHS PLUG



LH02-1564

A:9.5MM TV PLUG TO 9.5MM TV PLUG
B:9.5MM TV PLUG TO 9.5MM TV JACK



LH02-1565

A: 9.5MM TV PLUG TO 9.5MM TV PLUG, RIGHT ANGLE
 B: 9.5MM TV PLUG TO 9.5MM TV JACK, RIGHT ANGLE



LH02-1571

XLR ADAPTER, XLR PLUG TO 6.35MM MONO JACK



LH02-1578

SCART PLUG TO 3 RCA PLUG
 O.D 2.6 x 7.8MM CABLE

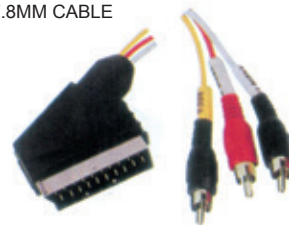

LH02-1566

F SCREW-ON TYPE PLUG TO F SCREW-ON TYPE PLUG



LH02-1572

XLR ADAPTER, XLR PLUG TO 3.5MM STEREO PLUG



LH02-1579

SCART PLUG TO 3 RCA PLUG
 A: O.D 6MM CABLE
 B: O.D 7MM CABLE

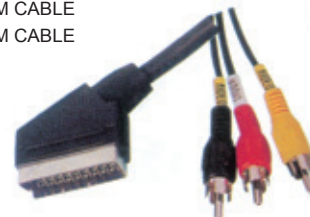

LH02-1567

F PUSH-ON TYPE PLUG TO F PUSH-ON TYPE PLUG



LH02-1573

SCART PLUG TO SCART PLUG 9 P

LH06-1574

SCART PLUG TO SCART PLUG 21 P ELECTRONIC CABLE

A: O.D 7MM
 B: O.D 8MM
 C: O.D 10MM



LH02-1580

SCART PLUG TO 3RCA PLUG
 O.D 2.6MM+4MM+2.6MM WITH SWITCH



LH02-1568

2.5MM STEREO PLUG TO 2.5MM STEREO PLUG RIGHT ANGLE



LH02-1575

SCART PLUG TO SCART PLUG 21 P

A: O.D 10MM STANDARD CABLE
 B: O.D 11MM STANDARD CABLE



LH02-1581

SCART PLUG TO 4 RCA PLUG
 O.D 2.6 x 10.4MM CABLE



LH02-1569

XLR ADAPTER, RCA PLUG TO XLR JACK



LH02-1576

SCART PLUG TO 2 RCA PLUG
 A: O.D 2.6 x 5.2MM CABLE

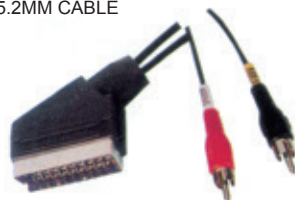

LH02-1582

SCART PLUG TO 4 RCA PLUG
 O.D 8MM CABLE



LH02-1570

XLR ADAPTER, XLR PLUG TO RCA JACK



LH02-1577

SCART PLUG TO 2 RCA PLUG
 A: O.D 6MM CABLE
 B: O.D 7MM CABLE

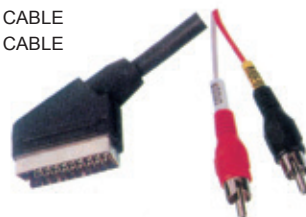

LH02-1583

SCART PLUG TO 6 RCA PLUG
 A: O.D 8.5MM CABLE
 B: O.D 9MM CABLE



LH02-1584

• 6P2C
• 6P4C
TELEPHONE LINE CORD
MALE TO SPADE LUGS



LH02-1590

SINGLE SURFACE JACK
A: 6P4C
A: 6P6C



LH02-1596

CORD COUPER
A: 6P4C
A: 6P6C
C:8P8C



LH02-1585

• 6P2C
• 6P4C
• 6P6C
TELEPHONE
LINE CORD
MALE TO MALE



LH02-1591

SINGLE SURFACE JACK
A: 6P4C
A: 6P6C



LH02-1597

RJ45 PVC BOOT
COLOUR: GREY,
BLUE YELLOW,
RED GREEN,
ORANGE



LH02-1586

• 6P2C
• 6P4C
• 6P6C
TELEPHONE
LINE CORD
MALE TO FEMALE
W/2 PLUG



LH02-1592

SURFACE JACK
A: 6P4C
A: 6P6C
C:8P8C



LH02-1598

RJ45 PLUG
A: WITHOUT SHIELD
B: WITH SHIELD



LH02-1587

• 4P4C
TELEPHONE
HANDSET
COIL CORD



LH02-1593

3WAY JACK
6P4C

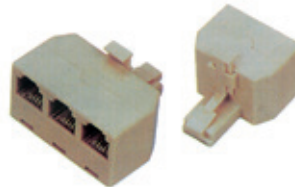

LH02-1599

MODULAR PLUG
A: 6P2C
A: 4P4C
A: 6P4C
A: 6P6C



LH02-1588

• 6P2C
• 6P4C
• 6P6C
TELEPHONE
EXTENSION
CORD
MALE TO FEMALE
W/2 PLUG, COIL CORD



LH02-1594

DUPLEX JACK
A: 6P4C
A: 6P6C
C:8P8C



LH02-1600

6P2C
6P4C
6P6C
8P8C
8P4C



LH02-1589

• 6P4C
CONVERSION
CORD



LH02-1595

TRIPLEX ADAPTOR
A: 6P4C
A: 6P6C
C:8P8C



LH02-1601

6P2C
8P4C
6P6C



LH02-1602
UTP Video Balun

Use UTP as per the transmit medium, put video signal processing as the difference signal between a pair same amplitude, and a polarity opposition, process middle long distance video transmit, can put the cable electrical resist to zero, effective control same



LH02-1603
Video Balun Transmission

Effective transmission distance: 300-450m



LH02-1604
Video Balun Transmission

The passive single-channel network wire video transponder (cat.5:300m, bnc male connector), the compact integrated design, built-in 2 levels of lightning protection only transmit the video signal, the effective transmission multicolor video signal 200-350 meter



LH02-1605
Video Balun Transmission

Effective transmission distance: 300-450m

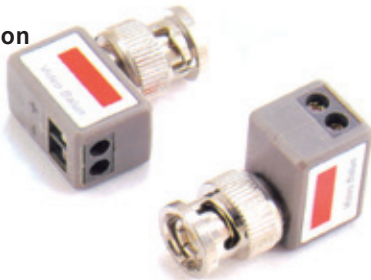

LH02-1606
BNC PLUG TO BNC PLUG



LH02-16087
BNC MALE+DC PLUG TO BNC MALE+DC JACK



LH02-1608
DC JACK TO 2 DC PLUG
A: 5.5X2.1MM
B: 5.5X2.5MM



LH02-1609
DC JACK TO 4 DC PLUG
A: 5.5X2.1MM
B: 5.5X2.5MM



LH02-1610
DC JACK +RCA JACK TO MINI MICROPHONE FOR CCTV CABLE



LH02-1611
DC JACK POWER CORD PIGTAIL
A: 5.5X2.1MM
B: 5.5X2.5MM



LH02-1612
DC PLUG POWER CORD PIGTAIL
A: 5.5X2.1MM
B: 5.5X2.5MM



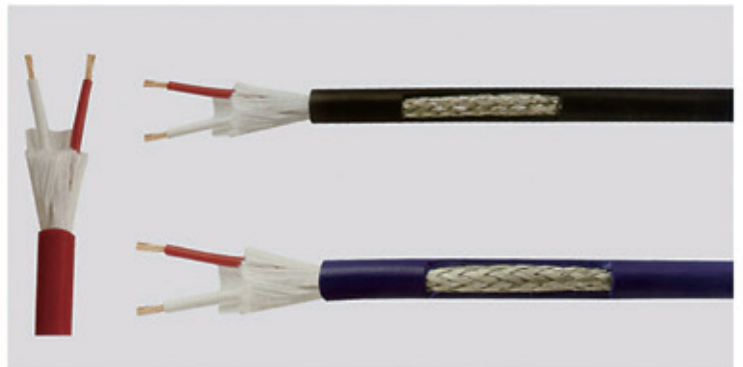

A large range of electric or electronic instruments connect the instrument to the amplifier, such as the electric guitar, electric bass, synthesizer, electric piano, or electronic drum machines. This cable features a braided shield for EMI rejection and durable.

Conductor: OFC, TC, CCA, TCCA

Jacket: PVC or PE

Quality Noise Free Performance

Compatible with: Home video and audio Hi-Fi

Braid and foil shield



Item NO.	Description	Outside Diameter
LH02-1623	1c x 28 /0.15mm, ID:2.1mmpvc + cottonyarn + aluminum foil + 96/0.12 braid	OD:6.0mm flexible PVC
LH02-1624	1c x 21 /0.18mm, ID:2.1mmpvc + cottonyarn + aluminum foil + 96/0.12 braid	OD:6.0mm flexible PVC
LH02-1625	2c x 23 /0.12mm, ID:1.5mmpvc + cottonyarn + aluminum foil + 128/0.12 braid	OD:6.0mm flexible PVC
LH02-1626	2c x 32 /0.10mm, ID:1.5mmpvc + cottonyarn + aluminum foil + 144/0.12 braid	OD:6.5mm flexible PVC
LH02-1627	2c x 21 /0.12mm, ID:1.6mmpvc + cottonyarn + aluminum foil + 112/0.12 braid	OD:6.5mm flexible PVC

LH02-1628
2-WAY SPLITTER
5-900 MHz



LH02-1635
2-WAY SPLITTER
5-1000 MHz



LH02-1642
4-WAY SPLITTER
5-2050 MHz



LH02-1629
2-WAY SPLITTER
5-900 MHz



LH02-1636
3-WAY SPLITTER
5-1000 MHz



LH02-1643
6-WAY SPLITTER
5-2450 MHz



LH02-1630
3-WAY SPLITTER
5-900 MHz



LH02-1637
4-WAY SPLITTER
5-1000 MHz



LH02-1644
8-WAY SPLITTER
5-2450 MHz

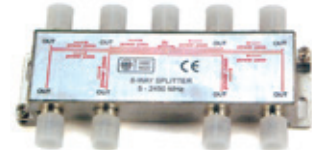

LH02-1631
4-WAY SPLITTER
5-900 MHz



LH02-1638
6-WAY SPLITTER
5-1000 MHz



LH02-1645
2-WAY SPLITTER
5-1000 MHz



LH02-1632
6-WAY SPLITTER
5-900 MHz



LH02-1639
9-WAY SPLITTER
5-1000 MHz



LH02-1646
3-WAY SPLITTER
5-1000 MHz



LH02-1633
8-WAY SPLITTER
5-900 MHz



LH02-1640
2-WAY SPLITTER
5-2050 MHz



LH02-1647
4-WAY SPLITTER
5-1000 MHz

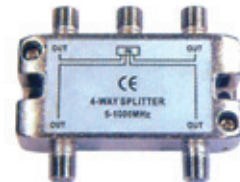

LH02-1634
2-WAY SPLITTER
5-1000 MHz



LH02-1641
3-WAY SPLITTER
5-2050 MHz



LH02-1648
6-WAY SPLITTER
5-1000 MHz



LH02-1649

8-WAY SPLITTER
5-1000 MHz



LH02-1656

5-2200 MHz 3WAYS BIG HOUSING SAT.SPLITTER



LH02-1663

ANTENNA/CABLE SWITCH



LH02-1650

5-2400 MHz 2WAYS BIG HOUSING SAT. SPLITTER



LH02-1657

5-2200 MHz 2WAYS BIG HOUSING SAT.SPLITTER



LH02-1664

2*1 DISEQC 2.0+TONE BURST 950-2300MHZ, 2.0 VERSION



LH02-1651

5-2400 MHz 3WAYS BIG HOUSING SAT. SPLITTER



LH02-1658

5-2300 MHz 6WAYS BIG HOUSING SAT.SPLITTER



LH02-1665

4*1 DISEQC 2.0+TONE BURST 950-2300MHZ, 2.0 VERSION



LH02-1652

5-2400 MHz 4WAYS BIG HOUSING SAT. SPLITTER

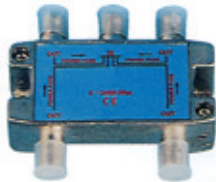

LH02-1659

5-2300 MHz 8WAYS BIG HOUSING SAT.SPLITTER

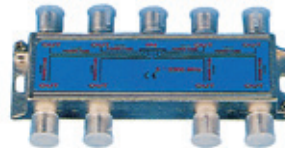

LH02-1666

2*1 DISEQC SWITCH 950-2400MHZ, 2.0 VERSION



LH02-1653

5-2400 MHz 6WAYS BIG HOUSING SAT. SPLITTER

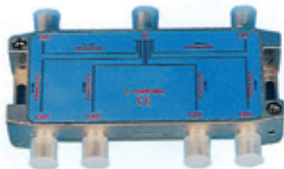

LH02-1660

ANTENNA/CABLE SWITCH



LH02-1667

4*1 DISEQC SWITCH 950-2400MHZ, 2.0 VERSION



LH02-1654

5-2400 MHz 8WAYS BIG HOUSING SAT.SPLITTER

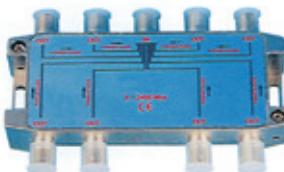

LH02-1661

ANTENNA/CABLE SWITCH



LH02-1668

2-WAY SPLITTER 0-1000MHz



LH02-1655

5-2300 MHz 2WAYS BIG HOUSING SAT.SPLITTER

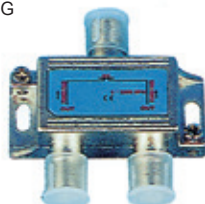

LH02-1662

ANTENNA/CABLE SWITCH



LH02-1669

2-WAY SPLITTER 0-1000MHz



LH02-1670
2-WAY SPLITTER
5-1000MHz



LH02-1677
5-WAY SPLITTER
PLASTIC



LH02-1684
WALL SOCKET TV/FM
STANDARD



LH02-1671
2-WAY SPLITTER
5-1000MHz



LH02-1678
2-WAY SPLITTER
5-1000MHz



LH02-1685
F MALE TERMINATOR
A:50 OHM
B:75 OHM
C:90 OHM



LH02-1672
2-WAY SPLITTER



LH02-1679
SINGLE GROUND BLOCK
A.ECONOMIC
B.2.4G



LH02-1686
F CONNECTOR
A:RG58
B:RG59
C:RG6



LH02-1673
4-WAY SPLITTER

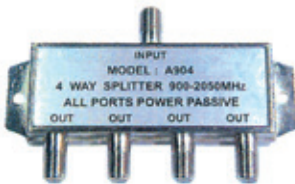

LH02-1680
DUAL GROUND BLOCK
A.ECONOMIC
B.2.4G



LH02-1687
F CONNECTOR
A:RG58
B:RG59
C:RG6



LH02-1674
2-WAY SPLITTER
PLASTIC



LH02-1681
WALL SOCKET
TV,JACK



LH02-1688
F CONNECTOR
A:RG58
B:RG59
C:RG6



LH02-1675
3-WAY SPLITTER
PLASTIC



LH02-1682
WALL SOCKET F
FEMALE PLUG



LH02-1689
F CONNECTOR
A:RG58
B:RG59
C:RG6



LH02-1676
4-WAY SPLITTER
PLASTIC



LH02-1683
WALL SOCKET TV
FEMALE AND F FEMALE
PLUG



LH02-1690
F CONNECTOR
A:RG58
B:RG59
C:RG6



LH02-1691

F CONNECTOR
A:RG58
B:RG59
C:RG6



LH02-1698

F CONNECTOR
THREE SETS
A:RG59
B:RG6



LH02-1705

F PLUG COMPRESSION
TYPE RG6U



LH02-1692

F CONNECTOR
RG11



LH02-1699

F CONNECTOR
THREE SETS
A:RG59
B:RG6



LH02-1706

F PLUG COMPRESSION
TYPE RG6U



LH02-1693

F CONNECTOR
WITH RING
A:RG59



LH02-1700

F CONNECTOR
THREE SETS
A:RG59
B:RG6



LH02-1707

F PLUG
COMPRESSION
TYPE



LH02-1694

F CONNECTOR
WITH RING
A:RG6



LH02-1701

F PLUG



LH02-1708

F PLUG
COMPRESSION
TYPE



LH02-1695

F CONNECTOR
MOLDED TYPE



LH02-1702

F PLUG COMPRESSION TYPE
A:RG59
B:RG6U



LH02-1709

F ADAPTER F-F
A:W/ WASHER & NUT
B:W/O WASHER & NUT



LH02-1696

F CONNECTOR
MOLDED TYPE



LH02-1703

F PLUG COMPRESSION
TYPE



LH02-1710

F ADAPTER F-F
A:W/ WASHER & NUT
B:W/O WASHER & NUT



LH02-1697

F CONNECTOR
WITH RING
A:RG59
B:RG6



LH02-1704























F PLUG COMPRESSION
TYPE RG6U



LH02-1711

F ADAPTER F-F
A:W/ WASHER & NUT
B:W/O WASHER & NUT



<p>LH02-1712 F CONNECTOR F-61 A:W/ WASHER & NUT B:W/O WASHER & NUT</p> 	<p>LH02-1722 F FOUR FEMALE</p> 	<p>LH02-1732 F FEMALE TO 9.5MM TV FEAMLE RIGHT ANGLE 90°</p> 
<p>LH02-1713 F FEMALE BULKHEAD A:W/ WASHER & NUTS B:W/O WASHER & NUTS</p> 	<p>LH02-1723 F FEMALE TO 9.5MM TV MALE</p> 	<p>LH02-1733 F FEMALE TO 9.5MM TV FEAMLE RIGHT ANGLE 90°</p> 
<p>LH02-1714 F FEMALE BULKHEAD RECEPTACLE(F-61) A:W/ WASHER & NUTS B:W/O WASHER & NUTS</p> 	<p>LH02-1724 F FEMALE TO 9.5MM TV FEMALE</p> 	<p>LH02-1734 F FEMALE TO F QUICK MALE RIGHT ANGLE 90°</p> 
<p>LH02-1715 F FEMALE PC MOUNT</p> 	<p>LH02-1725 F FEMALE TO 9.5MM TV FEMALE</p> 	<p>LH02-1735 F MALE TO 9.5MM TV FEMALE</p> 
<p>LH02-1716 RIGHT ANGLE F FEMALE PC MOUNT</p> 	<p>LH02-1726 F FEMALE TO F QUICK MALE</p> 	<p>LH02-1736 F MALE TO 9.5MM TV FEMALE</p> 
<p>LH02-1717 RIGHT ANGLE F FEMALE PC MOUNT WITH BRACKET</p> 	<p>LH02-1727 F FEMALE TO RCA MALE</p> 	<p>LH02-1737 F MALE TO 9.5MM TV FEMALE</p> 
<p>LH02-1718 F THREE FEMALE</p> 	<p>LH02-1728 F FEMALE TO RCA FEMALE</p> 	<p>LH02-1738 F MALE TO RCA MALE</p> 
<p>LH02-1719 F MALE TO 2XFEMALE</p> 	<p>LH02-1729 F FEMALE TO F MALE</p> 	<p>LH02-1739 F MALE TO F MALE</p> 
<p>LH02-1720 F QUICK MALE TO 2XFEMALE</p> 	<p>LH02-1730 F FEMALE TO F MALE RIGHT ANGLE 90°</p> 	<p>LH02-1740 9.5MM TV FEMALE TO RCA MALE</p> 
<p>LH02-1721 F MALE TO 3XFEMALE</p> 	<p>LH02-1731 F FEMALE TO 9.5MM TV MALE RIGHT ANGLE 90°</p> 	<p>LH02-1741 9.5MM TV FEMALE TO RCA MALE</p> 

LH02-1742
9.5MM TV FEMALE TO
F QUICK MALE



LH02-1752
9.5MM TV MALE



LH02-1762
BNC FEMALE TO
F MALE



LH02-1743
9.5MM TV FEMALE TO
RCA FEMALE



LH02-1753
9.5MM TV MALE
RIGHT ANGLE 90°



LH02-1763
BNC FEMALE TO
F FEMALE



LH02-1744
F QUICK MALE TO
RCA FEMALE



LH02-1754
F QUICK MALE
RIGHT ANGLE 90°



LH02-1764
BNC FEMALE TO
9.5MM TV MALE



LH02-1745
9.5MM TV MALE TO
RCA FEMALE



LH02-1755
F QUICK MALE



LH02-1765
BNC FEMALE TO NUT



LH02-1746
9.5MM TV FEMALE TO
RCA FEMALE



LH02-1756
F QUICK MALE



LH02-1766
BNC FEMALE TO RCA
MALE



LH02-1747
9.5MM TV FEMALE
CONNECTOR



LH02-1757
BNC FEMALE



LH02-1767
BNC MALE TO
BNC FEMALE



LH02-1748
9.5MM TV MALE TO
9.5MM TV MALE



LH02-1758
BNC FEMALE
THREE SETS



LH02-1768
BNC MALE TO
RCA FEMALE



LH02-1749
9.5MM TV FEMALE TO
9.5MM TV FEMALE



LH02-1759
BNC FEMALE TO
BNC FEMALE



LH02-1769
BNC MALE TO
RCA MALE



LH02-1750
9.5MM TV MALE TO
9.5MM TV FEMALE



LH02-1760
BNC FEMALE TO
RCA FEMALE



LH02-1770
BNC MALE TO
F FEMALE



LH02-1751
COAXIAL DOUBLE
CONNECTOR



LH02-1761
BNC FEMALE TO
RCA FEMALE



LH02-1771
BNC MALE TO
F FEMALE



<p>LH02-1772 BNC MALE TO F MALE</p> 	<p>LH02-1782 BNC MALE TO BNC MALE</p> 	<p>LH02-1792 BNC FEMALE CONNECTOR</p> 
<p>LH02-1773 BNC MALE TO NUT</p> 	<p>LH02-1783 THREE BNC FEMALE</p> 	<p>LH02-1793 F FEMALE TO 9.5MM TV FEAMLE RIGHT ANGLE 90°</p> 
<p>LH02-1774 BNC MALE TO COAXIAL CONNECTOR</p> 	<p>LH02-1784 BNC MALE TO BNC 2XFEMALE</p> 	<p>LH02-1794 BNC MALE CONNECTOR</p> 
<p>LH02-1775 BNC MALE TO 9.9MM TV MALE</p> 	<p>LH02-1785 BNC MALE MOLDED TYPE</p> 	<p>LH02-1795 BNC MALE CONNECTOR</p> 
<p>LH02-1776 BNC MALE TO 9.9MM TV FEMALE</p> 	<p>LH02-1786 BNC MALE MOLDED TYPE</p> 	<p>LH02-1796 BNC MALE CONNECTOR</p> 
<p>LH02-1777 BNC ADAPTER</p> 	<p>LH02-1787 BNC MALE TWO SETS A:RG58, RG59, RG6</p> 	<p>LH02-1797 BNC MALE CONNECTOR</p> 
<p>LH02-1778 BNC MALE TO UHF FEMALE</p> 	<p>LH02-1788 BNC MALE TWO SETS RG58, RG59, RG6</p> 	<p>LH02-1798 BNC MALE CONNECTOR RIGHT ANGLE 90°</p> 
<p>LH02-1779 BNC MALE</p> 	<p>LH02-1789 BNC MALE THREE SETS</p> 	<p>LH02-1799 TNC MALE TO RCA MALE</p> 
<p>LH02-1780 BNC CONNECTOR</p> 	<p>LH02-1790 BNC FEMALE THREE SETS</p> 	<p>LH02-1800 TNC MALE TO RCA FEMALE</p> 
<p>LH02-1781 BNC CONNECTOR</p> 	<p>LH02-1791 BNC FEMALE CONNECTOR</p> 	<p>LH02-1801 TNC MALE TO F FEMALE</p> 

<p>LH02-1802 TNC MALE TO NUT</p> 	<p>LH02-1812 UHF DOUBLE FEMALE</p> 	<p>LH02-1822 A:3.5MM STEREO PLUG TO 3.5MM MONO JACK B:3.5MM STEREO PLUG TO 3.5MM STEREO JACK</p> 
<p>LH02-1803 TNC MALE THREE SETS</p> 	<p>LH02-1813 UHF MALE</p> 	<p>LH02-1823 A:3.5MM STEREO PLUG TO 2.5MM MONO JACK B:3.5MM STEREO PLUG TO 2.5MM STEREO JACK</p> 
<p>LH02-1804 TNC MALE TO 2XBNC FEMALE</p> 	<p>LH02-1814 UHF ACCESSORIE</p> 	<p>LH02-1824 A: 3.5MM MONO PLUG TO 6.35MM MONO JACK B: 3.5MM MONO PLUG TO 6.35MM STEREO JACK</p> 
<p>LH02-1805 TNC FEMALE THREE SETS RG58, RG59, RG6</p> 	<p>LH02-1815 UHF FEMALE BULKHEAD</p> 	<p>LH02-1825 A:3.5MM STEREO PLUG TO 6.35MM MONO JACK B:3.5MM STEREO PLUG TO 6.35MM STEREO JACK</p> 
<p>LH02-1806 TNC MALE THREE SETS RG58, RG59, RG6</p> 	<p>LH02-1816 MINI UHF MALE CRIMP TYPE A:RG-58/U B:RG-59/U C:RG-6/U</p> 	<p>LH02-1826 A:3.5 MM MONO PLUG TO 6.35 MM MONO JACK B:3.5 MM MONO PLUG TO 6.35MM STEREO JACK</p> 
<p>LH02-1807 TNC MALE RIGJT ANGLE 90°</p> 	<p>LH02-1817 TNC MALE TO UHF FEMALE</p> 	<p>LH02-1827 A:3.5MM STEREO PLUG TO 6.35MM MONO JACK B:3.5MM STEREO PLUG TO 6.35MM STEREO JACK</p> 
<p>LH02-1808 TNC MALE</p> 	<p>LH02-1818 TNC FEMALE TO UHF FEMALE</p> 	<p>LH02-1828 A:6.35MM MONO PLUG TO 3.5MM MONO JACK B:6.35MM MONO PLUG TO 3.5MM STEREO JACK</p> 
<p>LH02-1809 TNC MALE PANEL CRIMP A:RG58/U B:RG59/U C:RG6/U D:174/U</p> 	<p>LH02-1819 A:2.5MM MONO PLUG TO 3.5MM MONO JACK B:2.5MM MONO PLUG TO 3.5MM STEREO JACK</p> 	<p>LH02-1829 A:6.35MM STEREO PLUG TO 3.5MM MONO JACK B:6.35MM STEREO PLUG TO 3.5MM STEREO JACK</p> 
<p>LH02-1810 UHF FEMALE TO UHF FEMALE</p> 	<p>LH02-1820 A:2.5MM STEREO PLUG TO 3.5MM MONO JACK B:2.5MM STEREO PLUG TO 3.5MM STEREO JACK</p> 	<p>LH02-1830 A: 6.35MM MONO PLUG TO 6.35MM MONO JACK B: 6.35MM MONO PLUG TO 6.35MM STEREO JACK</p> 
<p>LH02-1811 UHF DOUBLE MALE</p> 	<p>LH02-1821 A:3.5MM MONO PLUG TO 3.5MM MONO JACK B:3.5MM MONO PLUG TO 3.5MM STEREO JACK</p> 	<p>LH02-1831 A: 6.35MM STEREO PLUG TO 6.35MM MONO JACK B: 6.35MM STEREO PLUG TO 6.35MM STEREO JACK</p> 

LH02-1832
2.5MM MONO PLUG
TO RCA JACK



LH02-1842
A: RCA PLUG TO
6.35MM MONO JACK
B: RCA PLUG TO
6.35MM STEREO JACK



LH02-1852
A: 3.5MM STEREO PLUG TO
2X3.5MM MONO JACK
B: 3.5MM STEREO PLUG TO
2X3.5MM STEREO JACK



LH02-1833
2.5MM STEREO PLUG
TO RCA JACK



LH02-1843
3.5MM MONO PLUG TO
9.5MM TV PLUG



LH02-1853
A: 3.5MM MONO PLUG TO
2X3.5MM MONO JACK
B: 3.5MM MONO PLUG TO
2X3.5MM STEREO JACK



LH02-1834
3.5MM MONO PLUG
TO RCA JACK



LH02-1844
3.5MM MONO PLUG TO
9.5MM TV JACK



LH02-1854
3.5MM STEREO PLUG TO
2X3.5MM STEREO JACK



LH02-1835
3.5MM STEREO PLUG
TO RCA JACK



LH02-1845
A: RCA PLUG TO RCA PLUG
NICKEL
B: RCA PLUG TO RCA PLUG,
GOLD



LH02-1855
3.5MM MONO PLUG TO
2X3.5MM MONO JACK



LH02-1836
6.35MM MONO PLUG
TO RCA JACK



LH02-1846
A: 9.5MM TV PLUG TO
RCA JACK
B: 9.5MM TV PLUG TO
RCA JACK, GOLD



LH02-1856
A: 3.5MM STEREO PLUG TO
2X3.5MM MONO JACK
B: 3.5MM STEREO PLUG TO
2X3.5MM STEREO JACK



LH02-1837
6.35MM MONO PLUG
TO RCA JACK



LH02-1847
RCA JACK TO
RCA JACK(L=32MM)



LH02-1857
A: 3.5MM STEREO PLUG TO
2RCA JACK
B: 2.5MM STEREO PLUG TO
2RCA JACK



LH02-1838
6.35MM STEREO PLUG
TO RCA JACK



LH02-1848
RCA JACK TO
RCA JACK, GOLD(R,B,G,W,Y)



LH02-1858
A: 3.5MM MONO PLUG TO
2RCA JACK



LH02-1839
6.35MM MONO PLUG
TO RCA PLUG



LH02-1849
RCA JACK TO
RCA JACK(L=41MM)



LH02-1859
3.5MM STEREO PLUG TO
2RCA JACK
GOLDEN PLATED



LH02-1840
6.35MM STEREO PLUG
TO RCA PLUG



LH02-1850
A: 2RCA JACK TO
2RCA JACK
B: 2RCA JACK TO
2RCA JACK
GOLDEN PLATED



LH02-1860
3.5MM MONO PLUG TO
2RCA PLUG



LH02-1841
A: RCA PLUG TO
6.35MM MONO JACK
B: RCA PLUG TO
6.35MM STEREO JACK



LH02-1851
A: 3RCA JACK TO
3RCA JACKS
B: 3RCA JACK TO
3RCA JACK
GOLDEN PLATED



LH02-1861
3.5MM STEREO PLUG TO
2RCA PLUG



LH02-1862

A: 6.35MM MONO PLUG TO 2X3.5MM MONO JACK
 B: 6.35MM MONO PLUG TO 2X3.5MM STEREO JACK



LH02-1872

A: 6.35MM STEREO PLUG TO 2X6.35MM MONO JACK
 B: 6.35MM STEREO PLUG TO 2X6.35MM STEREO JACK



LH02-1882

RCA JACK TO 2RCA PLUG



LH02-1863

6.35MM STEREO PLUG TO 2X3.5MM STEREO JACK



LH02-1873

A: RCA PLUG TO 2X6.35MM MONO JACK
 B: RCA PLUG TO 2X6.35MM STEREO JACK



LH02-1883

A: 3.5MM MONO JACK TO 2XRCA PLUG
 B: 3.5MM STEREO JACK TO 2XRCA PLUG



LH02-1864

A: RCA PLUG TO 2X3.5MM MONO JACK
 B: RCA PLUG TO 2X3.5MM STEREO JACK



LH02-1874

A: RCA PLUG TO RCA JACK, NICKEL
 B: RCA PLUG TO RCA JACK, GOLD

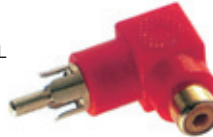

LH02-1884

A: 3.5MM MONO JACK TO 2XRCA JACK
 B: 3.5MM STEREO JACK TO 2XRCA JACK



LH02-1865

6.35MM MONO PLUG TO 2RCA JACK



LH02-1875

A: RCA PLUG TO RCA PLUG, NICKEL
 B: RCA PLUG TO RCA PLUG, GOLD



LH02-1885

2X3.5MM MONO PLUG TO 3.5MM STEREO JACK



LH02-1866

6.35MM STEREO PLUG TO 2RCA JACK



LH02-1876

RCA PLUG TO 2RCA JACK



LH02-1886

RCA PLUG TO DUAL JACK Y TYPE



LH02-1867

6.35MM MONO PLUG TO 2RCA PLUG



LH02-1877

RCA PLUG TO 2RCA JACK GOLD(R,B,G,W,Y)



LH02-1887

RCA JACK TO DUAL RCA JACK Y TYPE



LH02-1868

6.35MM STEREO PLUG TO 2RCA PLUG



LH02-1878

RCA PLUG TO 2RCA PLUG



LH02-1888

3.5MM MONO PLUG TO DUAL RCA JACK Y TYPE



LH02-1869

A: 3.5MM STEREO PLUG TO 2X6.35MM MONO JACK
 B: 3.5MM MONO PLUG TO 2X6.35MM STEREO JACK



LH02-1879

RCA PLUG TO 2RCA JACK



LH02-1889

3.5MM STEREO PLUG TO DUAL RCA JACK Y TYPE



LH02-1870

A: 3.5MM STEREO PLUG TO 2X6.35MM MONO JACK
 B: 3.5MM STEREO PLUG TO 2X6.35MM STEREO JACK



LH02-1880

RCA PLUG TO 2RCA PLUG



LH02-1890

6.35MM MONO PLUG TO DUAL RCA JACK Y TYPE



LH02-1871

A: 6.35MM MONO PLUG TO 2X6.35MM MONO JACK
 B: 6.35MM MONO PLUG TO 2X6.35MM STEREO JACK



LH02-1881

RCA JACK TO 2RCA JACK



LH02-1891

6.35MM STEREO PLUG TO DUAL RCA JACK Y TYPE



<p>LH02-1892 A: 3.5MM MONO PLUG TO 3.5MM MONO PLUG B: 3.5MM STEREO PLUG TO 3.5MM STEREO PLUG</p> 	<p>LH02-1902 A: 6.35MM STEREO PLUG TO 3.5MM MONO JACK B: 6.35MM STEREO PLUG TO 3.5MM STEREO JACK</p> 	<p>LH02-1912 A: 6.35MM STEREO PLUG TO 6.35MM MONO JACK B: 6.35MM STEREO PLUG TO 6.35MM STEREO JACK</p> 
<p>LH02-1893 A: 6.35MM MONO PLUG TO 6.35MM MONO PLUG B: 6.35MM STEREO PLUG TO 6.35MM STEREO PLUG</p> 	<p>LH02-1903 6.35MM MONO PLUG TO RCA PLUG</p> 	<p>LH02-1913 A: RCA JACK TO RCA JACK, NICKEL B: RCA JACK TO RCA JACK, GOLD</p> 
<p>LH02-1894 2RCA JACK AND S-VHS TO 2RCA JACK AND S-VHS</p> 	<p>LH02-1904 A: 3.5MM MONO PLUG TO 6.35MM MONO JACK B: 3.5MM MONO PLUG TO 6.35MM STEREO JACK</p> 	<p>LH02-1914 3.5MM MONO PLUG TO RCA JACK</p> 
<p>LH02-1895 A: 2.5MM MONO PLUG TO 3.5MM MONO JACK B: 2.5MM MONO PLUG TO 3.5MM STEREO JACK</p> 	<p>LH02-1905 A: 3.5MM MONO PLUG TO 6.35MM MONO JACK B: 3.5MM MONO PLUG TO 6.35MM STEREO JACK</p> 	<p>LH02-1915 3.5MM STEREO PLUG TO RCA JACK</p> 
<p>LH02-1896 A: 2.5MM STEREO PLUG TO 3.5MM MONO JACK B: 2.5MM STEREO PLUG TO 3.5MM STEREO JACK</p> 	<p>LH02-1906 A: 3.5MM STEREO PLUG TO 6.35MM MONO JACK B: 3.5MM STEREO PLUG TO 6.35MM STEREO JACK</p> 	<p>LH02-1916 3.5MM MONO PLUG TO RCA JACK</p> 
<p>LH02-1897 A: 3.5MM MONO PLUG TO 3.5MM MONO JACK B: 3.5MM MONO PLUG TO 3.5MM STEREO JACK</p> 	<p>LH02-1907 A: 3.5MM STEREO PLUG TO 6.35MM MONO JACK B: 3.5MM STEREO PLUG TO 6.35MM STEREO JACK</p> 	<p>LH02-1917 3.5MM STEREO PLUG TO RCA JACK</p> 
<p>LH02-1898 A: 3.5MM STEREO PLUG TO 2.5MM MONO JACK B: 3.5MM STEREO PLUG TO 2.5MM STEREO JACK</p> 	<p>LH02-1908 A: 3.5MM MONO PLUG TO 6.35MM MONO JACK B: 3.5MM MONO PLUG TO 6.35MM STEREO JACK</p> 	<p>LH02-1918 6.35MM MONO PLUG TO RCA JACK</p> 
<p>LH02-1899 A: RCA PLUG TO 3.5MM MONO JACK B: RCA PLUG TO 3.5MM STEREO JACK</p> 	<p>LH02-1909 A: 6.35MM STEREO PLUG TO 3.5MM MONO JACK B: 6.35MM STEREO PLUG TO 3.5MM STEREO JACK</p> 	<p>LH02-1919 6.35MM STEREO PLUG TO RCA JACK</p> 
<p>LH02-1900 A: RCA PLUG TO 6.35MM MONO JACK B: RCA PLUG TO 6.35MM STEREO JACK</p> 	<p>LH02-1910 A: RCA PLUG TO RCA PLUG, NICKEL B: RCA PLUG TO RCA PLUG, GOLD</p> 	<p>LH02-1920 6.35MM MONO PLUG TO RCA JACK</p> 
<p>LH02-1901 A: 6.35MM MONO PLUG TO 3.5MM MONO JACK B: 6.35MM MONO PLUG TO 3.5MM STEREO JACK</p> 	<p>LH02-1911 A: 6.35MM MONO PLUG TO 6.35MM MONO JACK B: 6.35MM MONO PLUG TO 6.35MM STEREO JACK</p> 	<p>LH02-1921 6.35MM STEREO PLUG TO RCA JACK</p> 

LH02-1922

A: 3.5MM MONO JACK TO
3.5MM MONO JACK
B: 3.5MM STEREO JACK TO
3.5MM STEREO JACK



LH02-1932

XLR(M)
3PINS



LH02-1942

XLR(M)
3PINS



LH02-1923

A: 6.35MM MONO JACK TO
6.35MM MONO JACK
B: 6.35MM STEREO JACK
TO 6.35MM STEREO
JACK



LH02-1933

XLR(F)
3PINS



LH02-1943

XLR(F)
3PINS



LH02-1924

3.5MM MONO PLUG TO
3.5MM MONO PLUG



LH02-1934

XLR(M)
3PINS



LH02-1944

XLR(M)
3PINS



LH02-1925

3.5MM STEREO PLUG TO
3.5MM STEREO PLUG



LH02-1935

XLR(F)
3PINS



LH02-1945

XLR(F)
3PINS



LH02-1926

6.35MM MONO PLUG TO
6.35MM MONO PLUG



LH02-1936

XLR(M)
3PINS



LH02-1946

XLR(M)
3PINS



LH02-1927

3,4,5,7PINS



LH02-1937

XLR(F)
3PINS



LH02-1947

XLR(F)
3PINS



LH02-1928

XLR(M)
3PINS



LH02-1938

XLR(M)
3PINS



LH02-1948

XLR(M)
3PINS



LH02-1929

XLR(F)
3PINS



LH02-1939

XLR(F)
3PINS



LH02-1949

XLR(F)
3PINS



LH02-1930

XLR(M)
3PINS



LH02-1940

XLR(M)
3PINS



LH02-1950

AXLR(M)
3PINS



LH02-1931

XLR(F)
3PINS



LH02-1941

XLR(F)
3PINS



LH02-1951

AXLR(F)
3PINS



<p>LH02-1952 XLR(M) 3PINS</p> 	<p>LH02-1962 SPN(F) 4PINS</p> 	<p>LH02-1972 M20 2-12PINS</p> 
<p>LH02-1953 XLR(F) 3PINS</p> 	<p>LH02-1963 SPN(F) 4PINS</p> 	<p>LH02-1973 M20 2-12PINS</p> 
<p>LH02-1954 XLR(M) 3PINS</p> 	<p>LH02-1964 SPN(M) 4PINS</p> 	<p>LH02-1974 2.5MM MONO PLUG</p> 
<p>LH02-1955 XLR(F) 3PINS</p> 	<p>LH02-1965 SPN(M) 4PINS</p> 	<p>LH02-1975 2.5MM STEREO PLUG</p> 
<p>LH02-1956 XLR(M) 3PINS</p> 	<p>LH02-1966 SPN(M) 4PINS</p> 	<p>LH02-1976 2.5MM MONO PLUG W/CABLE PROTECTOR</p> 
<p>LH02-1957 XLR(F) 3PINS</p> 	<p>LH02-1967 SPN(M) 4PINS</p> 	<p>LH02-1977 2.5MM STEREO PLUG W/CABLE PROTECTOR</p> 
<p>LH02-1958 XLR(M) 3PINS</p> 	<p>LH02-1968 M12 2-6PIN</p> 	<p>LH02-1978 2.5MM MONO PLUG METAL, W/SPRING</p> 
<p>LH02-1959 XLR(F) 3PINS</p> 	<p>LH02-1969 M12 2-6PINS</p> 	<p>LH02-1979 2.5MM STEREO PLUG METAL, W/SPRING</p> 
<p>LH02-1960 SPN(M) 4PINS</p> 	<p>LH02-1970 M16 2-10PINS</p> 	<p>LH02-1980 2.5MM MONO PLUG METAL, W/SPRING</p> 
<p>LH02-1961 SPN(M) 4PINS</p> 	<p>LH02-1971 M16 2-10PINS</p> 	<p>LH02-1981 2.5MM STEREO PLUG METAL, W/SPRING</p> 

LH02-1982
2.5MM MONO PLUG
METAL,HEAVY DUTY



LH02-1992
3.5MM STEREO PLUG
RIGHT ANGLE



LH02-2002
6.35MM MONO PLUG
METAL,W/PLASTIC
PROTECTOR



LH02-1983
2.5MM STEREO PLUG
METAL,HEAVY DUTY



LH02-1993
3.5MM MONO PLUG
METAL,W/SPRING



LH02-2003
6.35MM STEREO PLUG
METAL,W/PLASTIC
PROTECTOR



LH02-1984
3.5MM MONO PLUG



LH02-1994
3.5MM STEREO PLUG
METAL,W/SPRING



LH02-2004
6.35MM MONO PLUG
METAL,W/SPRING



LH02-1985
3.5MM STEREO PLUG



LH02-1995
3.5MM MONO PLUG
METAL



LH02-2005
6.35MM STEREO PLUG
METAL,W/SPRING



LH02-1986
3.5MM MONO PLUG
W/CABLE PROTECTOR



LH02-1996
3.5MM STEREO PLUG
METAL



LH02-2006
6.35MM MONO PLUG
METAL,W/SPRING



LH02-1987
3.5MM STEREO PLUG
W/CABLE PROTECTOR



LH02-1997
5.23MM STEREO PLUG
METAL



LH02-2007
6.35MM STEREO PLUG
METAL,W/SPRING



LH02-1988
3.5MM 4C PLUG
W/CABLE PROTECTOR
GOLD



LH02-1998
6.35MM MONO PLUG



LH02-2008
6.35MM MONO PLUG
METAL,W/SPRING



LH02-1989
3.5MM MONO PLUG
METAL,W/SPRING



LH02-1999
6.35MM STEREO PLUG



LH02-2009
6.35MM STEREO PLUG
METAL,W/SPRING



LH02-1990
3.5MM STEREO PLUG
METAL,W/SPRING



LH02-2000
6.35MM MONO PLUG
W/PLASTIC
PROTECTOR



LH02-2010
6.35MM MONO PLUG
METAL,W/SPRING
BLACK FINISHED



LH02-1991
3.5MM MONO PLUG
RIGHT ANGLE



LH02-2001
6.35MM STEREO PLUG
W/PLASTIC
PROTECTOR



LH02-2011
6.35MM STEREO PLUG
METAL,W/SPRING
BLACK FINISHED



LH02-2012
6.35MM MONO PLUG
GOLD,W/SPRING



LH02-2022
6.35MM MONO PLUG
METAL Φ17.4



LH02-2032
6.35MM MONO PLUG
GOLD TIP



LH02-2013
6.35MM STEREO PLUG
GOLD,W/SPRING



LH02-2023
6.35MM STEREO PLUG
METAL Φ17.4



LH02-2033
6.35MM STEREO PLUG
GOLD TIP



LH02-2014
6.35MM MONO PLUG
GOLD,W/SPRING



LH02-2024
6.35MM MONO PLUG



LH02-2034
6.35MM MONO PLUG
GOLD

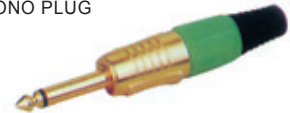

LH02-2015
6.35MM STEREO PLUG
GOLD,W/SPRING



LH02-2025
6.35MM STEREO PLUG



LH02-2035
6.35MM STEREO PLUG



LH02-2016
6.35MM MONO PLUG
METAL,ANGLE TYPE



LH02-2026
6.35MM MONO PLUG



LH02-2036
6.35MM MONO PLUG



LH02-2017
6.35MM STEREO PLUG
METAL,ANGLE TYPE



LH02-2027
6.35MM STEREO PLUG



LH02-2037
6.35MM STEREO PLUG



LH02-2018
6.35MM MONO PLUG
METAL
RIGHT ANGLE



LH02-2028
6.35MM MONO PLUG
GOLD TIP



LH02-2038
6.35MM MONO PLUG
GOLD



LH02-2019
6.35MM STEREO PLUG
METAL
RIGHT ANGLE



LH02-2029
6.35MM STEREO PLUG
GOLD TIP



LH02-2039
6.35MM STEREO PLUG
GOLD



LH02-2020
6.35MM MONO PLUG
RIGHT ANGLE



LH02-2030
6.35MM MONO PLUG
GOLD TIP



LH02-2040
6.35MM MONO PLUG
GOLD



LH02-2021
6.35MM STEREO PLUG
RIGHT ANGLE



LH02-2031
6.35MM STEREO PLUG
GOLD TIP



LH02-2041
6.35MM STEREO PLUG
GOLD



LH02-2042
6.35MM MONO PLUG
GOLD



LH02-2052
6.35MM MONO PLUG



LH02-2062
RCA JACK
W/CABLE PROTECTOR



LH02-2043
6.35MM STEREO PLUG
GOLD



LH02-2053
6.35MM MONO PLUG



LH02-2063
RCA PLUG
ANGLE TYPE



LH02-2044
6.35MM MONO PLUG



LH02-2054
6.35MM MONO PLUG



LH02-2064
RCA PLUG,METAL
W/CABLE PROTECTOR



LH02-2045
6.35MM STEREO PLUG



LH02-2055
RCA PLUG



LH02-2065
RCA JACK,METAL
W/CABLE
PROTECTOR



LH02-2046
6.35MM MONO PLUG
GOLD,W/SPRING



LH02-2056
RCA JACK



LH02-2066
RCA PLUG,METAL
W/SPRING
A)NICKEL
B)GOLD



LH02-2047
6.35MM STEREO PLUG
GOLD,W/SPRING



LH02-2057
RCA PLUG



LH02-2067
RCA JACK,METAL
W/SPRING
A)NICKEL
B)GOLD



LH02-2048
6.35MM MONO PLUG



LH02-2058
RCA JACK

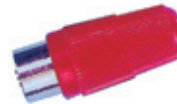

LH02-2068
RCA PLUG,METAL
W/SPRING
A)NICKEL
B)GOLD



LH02-2049
6.35MM MONO PLUG



LH02-2059
RCA PLUG
W/CABLE PROTECTOR



LH02-2069
RCA JACK,METAL
W/SPRING
A)NICKEL
B)GOLD



LH02-2050
6.35MM MONO PLUG



LH02-2060
RCA JACK
W/CABLE PROTECTOR



LH02-2070
RCA JACK,
BLACK FINISHED
GOLD



LH02-2051
6.35MM MONO PLUG



LH02-2061
RCA PLUG
W/CABLE PROTECTOR



LH02-2071
RCA JACK,
BLACK FINISHED
GOLD



LH02-2072

RCA PLUG
A:GOLD HEAD
NICKEL BODY
B:GOLD



LH02-2082

RCA GOLD PLUG



LH02-2092

RCA JACK



LH02-2073

RCA JACK
A:GOLD HEAD
NICKEL BODY
B:GOLD



LH02-2083

RCA GOLD PLUG



LH02-2093

A:2.5MM MONO JACK
B:2.5MM STEREO JACK



LH02-2074

RCA PLUG
GOLD HEAD BLUE
BODY



LH02-2084

RCA GOLD PLUG



LH02-2094

A:3.5MM MONO JACK
B:3.5MM STEREO JACK



LH02-2075

RCA PLUG
GOLD



LH02-2085

RCA GOLD PLUG



LH02-2095

A:2.5MM MONO JACK
W/CABLE PROTECTOR
B:2.5MM STEREO JACK
W/CABLE PROTECTOR



LH02-2076

RCA JACK
GOLD



LH02-2086

RCA GOLD PLUG



LH02-2096

A:3.5MM MONO JACK
W/CABLE PROTECTOR
B:3.5MM STEREO JACK
W/CABLE PROTECTOR



LH02-2077

RCA PLUG
GOLD



LH02-2087

RCA GOLD PLUG



LH02-2097

A:2.5MM MONO JACK,
METAL, W/SPRING
B:2.5MM STEREO JACK,
METAL, W/SPRING



LH02-2078

RCA PLUG
GOLD



LH02-2088

RCA GOLD PLUG



LH02-2098

A:2.5MM MONO JACK,
METAL, W/SPRING
B:2.5MM STEREO JACK,
METAL, W/SPRING



LH02-2079

RCA PLUG
GOLD



LH02-2089

RCA GOLD PLUG



LH02-2099

A:3.5MM MONO JACK
W/PLASTIC PROTECTOR
B:3.5MM STEREO JACK
W/PLASTIC
PROTECTOR



LH02-2080

RCA PLUG
GOLD
I.D.:6.5MM



LH02-2090

RCA JACK



LH02-2100

A:3.5MM MONO JACK,
METAL, W/SPRING
B:3.5MM STEREO JACK
METAL, W/SPRING



LH02-2081

RCA GOLD PLUG



LH02-2091

RCA JACK



LH02-2101

A:3.5MM MONO JACK
METAL, W/SPRING
B:3.5MM STEREO JACK
METAL, W/SPRING



LH02-2102

A:3.5MM MONO JACK
METAL, GOLD, W/SPRING
B:3.5MM STEREO JACK
METAL, GOLD,
W/SPRING



LH02-2112

A:2.5MM JACK
CLOSE CIRCUIT
B:3.5MM JACK
CLOSE CIRCUIT



LH02-2122

6.35MM STEREO JACK
OPEN CIRCUIT



LH02-2103

A:6.35MM MONO JACK
B:6.35MM STEREO JACK



LH02-2113

A:2.5MM JACK
OPEN CIRCUIT
B:3.5MM JACK
OPEN CIRCUIT



LH02-2123

6.35MM STEREO JACK
CLOSE CIRCUIT



LH02-2104

A:6.35MM MONO JACK
W/CABLE PROTECTOR
B:6.35MM STEREO
JACK W/CABLE
PROTECTOR



LH02-2114

A:2.5MM JACK
CLOSE CIRCUIT
B:3.5MM JACK
CLOSE CIRCUIT



LH02-2124

3.5MM STEREO
JACK OPEN CIRCUIT
3PIN



LH02-2105

A:6.35MM MONO
JACK
B:6.35MM STEREO
JACK



LH02-2115

3.5MM STEREO
JACK CIRCUIT



LH02-2125

3.5MM STEREO JACK
CLOSE CIRCUIT
4PIN



LH02-2106

A:6.35MM MONO JACK
METAL, W/SPRING
B:6.35MM STEREO JACK
METAL, W/SPRING



LH02-2116

6.35MM MONO JACK
OPEN CIRCUIT



LH02-2126

3.5MM STEREO
PHONE JACK
CLOSE CIRCUIT
5PIN



LH02-2107

A:6.35MM MONO JACK
METAL, W/SPRING
B:6.35MM STEREO
JACK METAL
W/SPRING



LH02-2117

6.35MM MONO JACK
CLOSED CIRCUIT



LH02-2127

3.5MM STEREO JACK
CLOSE CIRCUIT,4PIN



LH02-2108

A:6.35MM MONO JACK
METAL, W/SPRING
B:6.35MM STEREO JACK
METAL, W/SPRING



LH02-2118

6.35MM STEREO JACK
OPEN CIRCUIT



LH02-2128

A:2.5MM MONO JACK
B:3.5MM MONO JACK



LH02-2109

A:6.35MM MONO
JACK,METAL
B:6.35MM STEREO
JACK METAL



LH02-2119

6.35MM MONO JACK
CLOSE CIRCUIT



LH02-2129

3.5MM STEREO
JACK



LH02-2110

A:6.35MM MONO
JACK,METAL
B:6.35MM STEREO
JACK METAL



LH02-2120

6.35MM MONO JACK
OPEN CIRCUIT



LH02-2130

A:2.5MM MONO JACK
B:3.5MM MONO JACK



LH02-2111

A:2.5MM JACK
OPEN CIRCUIT
B:3.5MM JACK
OPEN CIRCUIT



LH02-2121

6.35MM MONO JACK
CLOSE CIRCUIT



LH02-2131

3.5MM STEREO JACK
CLOSE CIRCUIT
5PIN



<p>LH02-2132 3.5MM STEREO JACK</p> 	<p>LH02-2142 6.35MM STEREO JACK OPEN CIRCUIT</p> 	<p>LH02-2152 6.35MM MONO JACK CLOSE CIRCUIT</p> 
<p>LH02-2133 3.5MM MONO JACK CLOSE CIRCUIT 3PIN</p> 	<p>LH02-2143 6.35MM STEREO JACK CLOSE CIRCUIT</p> 	<p>LH02-2153 6.35MM MONO JACK CLOSE CIRCUIT WITH NUT</p> 
<p>LH02-2134 3.5MM MONO PHONE JACK CLOSE CIRCUIT 3PIN</p> 	<p>LH02-2144 6.35MM STEREO JACK DOUBLE SWITCHES</p> 	<p>LH02-2154 6.35MM STEREO JACK OPEN CIRCUIT</p> 
<p>LH02-2135 6.35MM MONO JACK OPEN CIRCUIT</p> 	<p>LH02-2145 6.35MM STEREO PHONE JACK CLOSED CIRCUIT DOUBLE SWITCHES</p> 	<p>LH02-2155 6.35MM STEREO JACK CLOSED CIRCUIT</p> 
<p>LH02-2136 6.35MM MONO JACK OPEN CIRCUIT</p> 	<p>LH02-2146 6.35MM MONO JACK OPEN CIRCUIT</p> 	<p>LH02-2156 6.35MM MONO JACK CLOSED CIRCUIT</p> 
<p>LH02-2137 6.35MM STEREO JACK OPEN CIRCUIT</p> 	<p>LH02-2147 6.35MM STEREO JACK OPEN CIRCUIT</p> 	<p>LH02-2157 6.35MM STEREO JACK OPEN CIRCUIT</p> 
<p>LH02-2138 6.35MM MONO JACK CLOSE CIRCUIT</p> 	<p>LH02-2148 6.35MM STEREO JACK CLOSED CIRCUIT</p> 	<p>LH02-2158 6.35MM STEREO JACK CLOSED CIRCUIT</p> 
<p>LH02-2139 6.35MM STEREO JACK CLOSE CIRCUIT</p> 	<p>LH02-2149 A:6.35MM MONO JACK OPEN CIRCUIT,SOLDER TYPE,2P B:6.35MM JACK CLOSE CIRCUIT SOLDER TYPE,4P</p> 	<p>LH02-2159 6.35MM MONO JACK CLOSED CIRCUIT</p> 
<p>LH02-2140 6.35MM MONO JACK OPEN CIRCUIT</p> 	<p>LH02-2150 A:6.35MM STEREO JACK OPEN CIRCUIT,SOLDER TYPE,3P B:6.35MM STEREO JACK CLOSE CIRCUIT SOLDER TYPE,6P</p> 	<p>LH02-2160 6.35MM STEREO JACK CLOSED CIRCUIT</p> 
<p>LH02-2141 6.35MM MONO JACK CLOSE CIRCUIT</p> 	<p>LH02-2151 6.35MM MONO JACK OPEN CIRCUIT</p> 	<p>LH02-2161 6.35MM STEREO JACK CLOSED CIRCUIT DOUBLE SWITCHES</p> 

LH02-2162

A:DC PLUG
1.0X3.5X9.0MM
B:DC PLUG
1.4X3.5X9.0MM



LH02-2172

DC PLUG
2.8X5.5X14.0MM



LH02-2182

P.C.B. LAYOUT
A:DC JACK 2.1X5.5
B:DC JACK 2.5X5.5



LH02-2163

A:DC PLUG 1.0X3.8X9.0MM
B:DC PLUG
1.4X3.5X9.0MM
W/CABLE
PROTECTOR



LH02-2173

DC PLUG 1.7X4.0X9.0MM
W/CABLE
PROTECTOR



LH02-2183

A:DC JACK 2.1X5.5
B:DC JACK 2.5X5.5



LH02-2164

A:DC PLUG
2.1X5.5X9.0MM
B:DC PLUG
2.5X5.5X9.0MM



LH02-2174

DC PLUG
1.0X2.5X9.0MM
W/PLASTIC HANDLE



LH02-2184

A:DC JACK 2.1X5.5
B:DC JACK 2.5X5.5



LH02-2165

A:DC PLUG 2.1X5.5X9.0MM
B:DC PLUG
2.5X5.5X9.0MM W/CABLE
PROTECTOR



LH02-2175

DC PLUG
1.0X2.5X9.0MM



LH02-2185

A:DC CHASSIS JACK
2.1X5.5
B:DC CHASSIS JACK
2.2X5.5



LH02-2166

A:DC PLUG
2.1X5.5X14.0MM
B:DC PLUG
2.5X5.5X14.0MM



LH02-2176

A:DC PLUG 2.8X5.5X14.0MM
B:DC PLUG 1.7X4.0X9.5MM
W/CABLE PROTECTOR



LH02-2186

DC PLUG
0.7X2.5X9.5MM
PLASTIC HANDLE



LH02-2167

A:DC PLUG 2.1X5.5X14.0MM
B:DC PLUG 2.5X5.5X14.0MM
W/CABLE
PROTECTOR



LH02-2177

DC PLUG 1.7X4.75X9.0MM
W/CABLE PROTECTOR



LH02-2187

DC PLUG
1.7X4X9.5MM
PLASTIC HANDLE



LH02-2168

DC PLUG
0.7X2.5X9MM



LH02-2178

2PIN PLUG TO DC PLUG



LH02-2188

DC PLUG
2.5X5.5MM



LH02-2169

DC PLUG 0.7X2.5X9MM
W/PLASTIC HANDLE



LH02-2179

DC PLUG 1.7X4X9.0MM



LH02-2189

ADC PLUG
1.4X3.4MM



LH02-2170

A:DC PLUG
3.1X6.3X9.0MM
B:DC PLUG
3.1X6.3X14.0MM



LH02-2180

DC PLUG 1.7X4X9.0MM
W/CABLE PROTECTOR



LH02-2190(A)

DC POWER JACK PIN
O.D.:2.1MM

LH02-2190(B)

DC POWER JACK PIN
O.D.:2.5MM



LH02-2171

A:DC PLUG 3.1X6.3X9.0MM
B:DC PLUG
3.1X6.3X14.0MM
W/CABLE
PROTECTOR



LH02-2181

P.C.B. LAYOUT
A:DC JACK 2.1X5.5
B:DC JACK 2.5X5.5



LH02-2191(A)

DC POWER JACK PIN
O.D.:2.1MM

LH02-2191(B)

DC POWER JACK PIN
O.D.:2.5MM



<p>LH02-2192(A) DC POWER JACK PIN O.D.:2.1MM</p> <p>LH02-2192(B) DC POWER JACK PIN O.D.:2.5MM</p> 	<p>LH02-2202(A) DC POWER JACK PIN O.D.:2.1MM</p> <p>LH02-2202(B) DC POWER JACK PIN O.D.:2.5MM</p> 	<p>LH02-2212 (3-8PIN) MINI DIN JACK TO (3-8PIN) MINI DIN JACK</p> 
<p>LH02-2193(A) DC CHASSIS JACK SHIELDED O.D.:2.1MM</p> <p>LH02-2193(B) DC CHASSIS JACK SHIELDED O.D.:2.5MM</p> 	<p>LH02-2203(A) DC POWER JACK PIN O.D.:2.1MM</p> <p>LH02-2203(B) DC POWER JACK PIN O.D.:2.5MM</p> 	<p>LH02-2213 (3-8PIN) MINI DIN JACK TO (3-8PIN) MINI DIN PLUG</p> 
<p>LH02-2194 A:DC CHASSIS JACK 2.1X5.5MM B:DC CHASSIS JACK 2.5X5.5MM</p> 	<p>LH02-2204(A) DC PLUG 2.1X5.5X17MM SCREW TYPE</p> <p>LH02-2204(B) DC PLUG 2.5X5.5X17MM SCREW TYPE</p> 	<p>LH02-2214 PAL MALE</p> 
<p>LH02-2195 DC CHASSIS JACK ADAPTOR A:2.1MM TO 2.1MM B:2.1MM TO 2.5MM C:2.5MM TO 2.5MM</p> 	<p>LH02-2205 MINI DIN PLUG WITH PLASTIC HANDLE(3-8PIN)</p> 	<p>LH02-2215 PAL FEMALE</p> 
<p>LH02-2196 DC JACK A:1.4X3.5X18MM E:2.1X5.5X18MM B:1.4X3.5X20MM F:2.5X5.5X18MM C:1.7X4.0MM G:4.2X7.0X19MM D:1.7X4.8X18MM</p> 	<p>LH02-2206 MINI DIN JACK WITH PLASTIC HANDLE(3-8PIN)</p> 	<p>LH02-2216 9.5MM TV SOCKET PCB MOUNT</p> 
<p>LH02-2197(A) DC POWER JACK PIN O.D.:1.0MM</p> <p>LH02-2197(B) DC POWER JACK PIN O.D.:1.3MM</p> 	<p>LH02-2207 4PIN MINI DIN PLUG, SOLDER TYPE</p> 	<p>LH02-2217 PAL PLUG PLASTIC HANDLE (A)RG-58 (B)RG-59 (C)RG-6 (D)RG-213</p> 
<p>LH02-2198(A) DC POWER JACK PIN O.D.:2.1MM</p> <p>LH02-2198(B) DC POWER JACK PIN O.D.:2.5MM</p> 	<p>LH02-2208 DIN PLUG WITH METAL SHELL, SCREW TYPE(3-8PIN)</p> 	<p>LH02-2218 TV SOCKET</p> 
<p>LH02-2199(A) DC POWER JACK PIN O.D.:2.1MM</p> <p>LH02-2199(B) DC POWER JACK PIN O.D.:2.5MM</p> 	<p>LH02-2209 DIN PLUG WITH PLASTIC HANDLE (3-9PIN)</p> 	<p>LH02-2219 TV SOCKET</p> 
<p>LH02-2200(A) DC POWER JACK PIN O.D.:2.1MM</p> <p>LH02-2200(B) DC POWER JACK PIN O.D.:2.5MM</p> 	<p>LH02-2210 DIN JACK WITH PLASTIC HANDLE (3-9PIN)</p> 	<p>LH02-2220 TV SUPPORT SOCKET</p> 
<p>LH02-2201(A) DC POWER JACK PIN O.D.:2.1MM</p> <p>LH02-2201(B) DC POWER JACK PIN O.D.:2.5MM</p> 	<p>LH02-2211 (3-8PIN) MINI DIN JACK TO (3-8PIN) MINI DIN JACK</p> 	<p>LH02-2221 BNC FEMALE TO 2PIN CONNECTOR</p> 

LH02-2222
DC MALE TO 2 PIN
CONNECTOR
A: DC 2.1X5.5MM
B: DC 2.5X5.5MM



LH02-2232
9.5MM TV PLUG



LH02-2242
9.5MM TV PLUG



LH02-2223
DC FEMALE TO 2 PIN
CONNECTOR
A: DC 2.1X5.5MM
B: DC 2.5X5.5MM



LH02-2233
9.5MM TV JACK



LH02-2243
9.5MM TV JACK



LH02-2224
DC MALE TO 2 PIN
CONNECTOR,ANGLE TYPE
A: DC 2.1X5.5MM
B: DC 2.5X5.5MM



LH02-2234
9.5MM TV PLUG



LH02-2244
9.5MM TV PLUGK



LH02-2225
3.5MM MONO PLUG
TO 2 PIN
CONNECTOR



83

LH02-2235
9.5MM TV JACK



LH02-2245
9.5MM TV JACK



LH02-2226
6.5MM MONO PLUG
TO 2 PIN
CONNECTOR



LH02-2236
9.5MM TV PLUG



LH02-2246
9.5MM TV PLUG RIGHT
ANGLE



LH02-2227
RJ45 PLUG
TO 8 PIN
CONNECTOR



LH02-2237
9.5MM TV JACK



LH02-2247
9.5MM TV JACK RIGHT
ANGLE



LH02-2228
3.5MM STEREO PLUG
TO 3 PIN
CONNECTOR



LH02-2238
9.5MM TV PLUG



LH02-2248
9.5MM TV PLUG



LH02-2229
RCA MALE TO 2 PIN
CONNECTOR



LH02-2239
9.5MM TV JACK



LH02-2249
9.5MM TV JACK



LH02-2230
RCA FEMALE TO 2 PIN
CONNECTOR



LH02-2240
9.5MM TV PLUG



LH02-2250
COAXIAL CONNECTOR



LH02-2231
BNC MALE TO 2 PIN
CONNECTOR



LH02-2241
9.5MM TV JACK



LH02-2251
COAXIAL CONNECTOR
SCREW TYPE



<p>LH02-2252 COAXIAL CONNECTOR SCREW TYPE</p> 	<p>LH02-2262 9.5MM TV JACK, RIGHT ANGLE</p> 	<p>LH02-2272 A:9.0MM MALE TO 9.5MM MALE B:9.0MM MALE TO 9.5MM FEMALE C:9.0MM FEMALE TO 9.5MM MALE D:9.0MM FEMALE TO 9.5MM FEMALE</p> 
<p>LH02-2253 9.5MM TV PLUG</p> 	<p>LH02-2263 9.5MM TV PLUG, RIGHT ANGLE</p> 	<p>LH02-2273 9.5MM MALE TO 9.5MM MALE</p> 
<p>LH02-2254 9.5MM TV JACK</p> 	<p>LH02-2264 9.5MM TV JACK, RIGHT ANGLE</p> 	<p>LH02-2274 9.5MM MALE TO 9.5MM FEMALE</p> 
<p>LH02-2255 9.5MM TV PLUG</p> 	<p>LH02-2265 9.5MM TV PLUG, RIGHT ANGLE</p> 	<p>LH02-2275 A: 9.0MM MALE TO 9.0MM FEMALE B: 9.5MM MALE TO 9.5MM FEMALE</p> 
<p>LH02-2256 9.5MM TV JACK</p> 	<p>LH02-2266 9.5MM TV PLUG, RIGHT ANGLE</p> 	<p>LH02-2276 9.5MM MALE TO 9.5MM FEMALE</p> 
<p>LH02-2257 9.5MM TV PLUG, ANGLE TYPE, SEPARABLE COVER</p> 	<p>LH02-2267 9.5MM TV JACK, RIGHT ANGLE</p> 	<p>LH02-2277 QUICK F MALE</p> 
<p>LH02-2258 9.5MM TV JACK, ANGLE TYPE, SEPARABLE COVER</p> 	<p>LH02-2268 9.5MM TV PLUG, RIGHT ANGLE</p> 	<p>LH02-2278 9.5MM TV PLUG TO 2X9.5MM TV JACKS</p> 
<p>LH02-2259 9.5MM TV PLUG,ANGLE TYPE CONNECTED COVER</p> 	<p>LH02-2269 9.5MM TV JACK, RIGHT ANGLE</p> 	<p>LH02-2279 9.5MM TV JACK TO 2X9.5MM TV PLUGS</p> 
<p>LH02-2260 9.5MM TV JACK ANGLE TYPE CONNECTED COVER</p> 	<p>LH02-2270 A: 9.00MM MALE TO 9.00 MALE B: 9.5MM MALE TO 9.5MM MALE</p> 	<p>LH02-2280 9.5MM TV PLUG TO 2X9.5MM TV JACKS MINI TYPE</p> 
<p>LH02-2261 9.5MM TV PLUG, RIGHT ANGLE</p> 	<p>LH02-2271 A: 9.00MM FEMALE TO 9.0MM FEMALE B: 9.5MM FEMALE TO 9.5MM FEMALE</p> 	<p>LH02-2281 9.5MM TV JACK TO 2X9.5MM TV PLUGS MINI TYPE</p> 

<p>LH02-2282 A: 9.5MM TV PLUG TO 2X9.5MM TV JACKS A: 9.00MM TV PLUG TO 2X9.0MM TV JACKS</p> 	<p>LH02-2292 9.5MM TV JACK TO 3X9.5MM TV PLUGS</p> 	<p>LH02-2302 9.5MM PLUG, 300OHM INPUT /750OH OUTPUT</p> 
<p>LH02-2283 A: 9.5MM TV JACK TO 2X9.5MM TV PLUGS A: 9.00MM TV JACK TO 2X9.0MM TV PLUGS</p> 	<p>LH02-2293 9.5MM TV PLUG TO 3X9.5MM TV JACKS</p> 	<p>LH02-2303 9.5MM PLUG,300OHM INPUT/750OH OUTPUT</p> 
<p>LH02-2284 2X9.5MM TV PLUGS TO 2X9.5MM TV JACKS</p> 	<p>LH02-2294 9.5MM TV PLUG TO 2X9.5MM TV JACKS</p> 	<p>LH02-2304 9.5MM PLUG 300 OHM INPUT / 75 OHM OUTPUT</p> 
<p>LH02-2285 9.5MM TV PLUG TO 2X9.5MM TV JACKS</p> 	<p>LH02-2295 9.5MM TV PLUG TO 2X9.5MM TV JACKS W/ANT/GAME SWITCH</p> 	<p>LH02-2305 F QUICK PLUG 300 OHMS INPUT/75 OHMS OUTPUT W/CAP A:W/NUT B:W/O NUT</p> 
<p>LH02-2286 9.5MM TV JACK TO 2X9.5MM TV PLUGS</p> 	<p>LH02-2296 9.5MM TV PLUG TO 2X9.5MM TV JACKS</p> 	<p>LH02-2306 MATCHING TRANSFORMER F QUICK 300Ω INPUT / 75Ω OUTPUT</p> 
<p>LH02-2287 9.5MM TV PLUG TO 2X9.5MM TV JACKS</p> 	<p>LH02-2297 9.5MM TV JACK</p> 	<p>LH02-2307 MATCHING TRANSFORMER F QUICK 300Ω INPUT / 75Ω OUTPUT</p> 
<p>LH02-2288 9.5MM TV JACK TO 2X9.5MM TV PLUGS</p> 	<p>LH02-2298 2X9.5MM TV JACKS</p> 	<p>LH02-2308 MATCHING TRANSFORMER F QUICK 300Ω INPUT / 75Ω OUTPUT</p> 
<p>LH02-2289 9.5MM TV PLUG TO 2X9.5MM TV JACKS</p> 	<p>LH02-2299 9.5MM PLUG 300 OHM INPUT/750HM OUTPUT DIFFERENT COLORS</p> 	<p>LH02-2309 F QUICK PLUG 300 OHMS INPUT/75 OHMS OUTPUT W/O CAP & NUT</p> 
<p>LH02-2290 9.5MM TV JACK TO 2X9.5MM TV PLUGS</p> 	<p>LH02-2300 9.5MM PLUG, RIGHT ANGLE CONNECTOR COVER</p> 	<p>LH02-2310 F QUICK PLUG 300 OHMS INPUT/75 OHMS OUTPUT</p> 
<p>LH02-2291 9.5MM TV PLUG TO 2X9.5MM TV JACKS W/SWITCH</p> 	<p>LH02-2301 9.5MM TV JACK, RIGHT ANGLE CONNECTOR COVER</p> 	<p>LH02-2311 9.5MM PLUG 300 OHM INPUT/ 75 OHM OUTPUT</p> 

<p>LH02-2312 9.5MM PLUG 300 OHM INPUT/ 75 OHM OUTPUT</p> 	<p>LH02-2322 UHF/VHF BAND SEPARATOR INPUT: 75 OHM UHF:300 OHM</p> 	<p>LH02-2332 BATTERY CLIP 5A COLOR: BLACK,RED L:50MM</p> 
<p>LH02-2313 300 OHM IN 75 OHM F JACK INPUT QUICK F PLUG OUTPUT</p> 	<p>LH02-2323 ALLIGATOR CLIP(W/BOOT) COLOR: BLACK,RED L:44MM(SMALL SIZE)</p> 	<p>LH02-2333 BATTERY CLIP 10A COLOR: BLACK,RED L:50MM</p> 
<p>LH02-2314 QUICK F PLUG 300OHM INPUT/ 75 OHM OUTPUTW</p> 	<p>LH02-2324 ALLIGATOR CLIP(W/BOOT) COLOR: BLACK,RED L:46MM(MEDIUM SIZE)</p> 	<p>LH02-2334 BATTERY CLIP 10A COLOR: BLACK,RED L:55MM</p> 
<p>LH02-2315 F JACK UHF/VHF/FM MATCHING TRANSFORMER INPUT 75 OHM OUTPUT 300 OHM</p> 	<p>LH02-2325 ALLIGATOR CLIP(W/BOOT) COLOR: BLACK,RED L:50MM(LARGE SIZE)</p> 	<p>LH02-2335 BATTERY CLIP 15A COLOR: BLACK,RED L:75MM</p> 
<p>LH02-2316 9.5MM JACK UHF/VHF/FM MATCHING TRANSFORMER INPUT 75 OHM OUTPUT 300 OHM</p> 	<p>LH02-2326 ALLIGATOR CLIP COLOR: BLACK,RED L:52MM</p> 	<p>LH02-2336 BATTERY CLIP 20A COLOR: BLACK,RED L:73MM</p> 
<p>LH02-2317 75 OHM HIGH PASS FILTER</p> 	<p>LH02-2327 ALLIGATOR CLIP COLOR: BLACK,RED L:35MM</p> 	<p>LH02-2337 BATTERY CLIP 30A COLOR: BLACK,RED L:75MM</p> 
<p>LH02-2318 INDOOR/OUTDOOR MATCHING TRANSFORMER</p> 	<p>LH02-2328 ALLIGATOR CLIP,W/SCREW COLOR: BLACK,RED L:55MM/66MM</p> 	<p>LH02-2338 BATTERY CLIP 30A COLOR: BLACK,RED L:75MM</p> 
<p>LH02-2319 INDOOR/OUTDOOR MATCHING TRANSFORMER</p> 	<p>LH02-2329 ALLIGATOR CLIP W/BOOT COLOR: BLACK,RED L:55MM</p> 	<p>LH02-2339 BATTERY CLIP 30A COLOR: RED,BLACK L:75MM</p> 
<p>LH02-2320 UHF/VHF/FM MATCHING TRANSFORMER INPUT-75 OHM OUTPUT-300 OHM</p> 	<p>LH02-2330 ALLIGATOR CLIP W/ SCREW L:48MM</p> 	<p>LH02-2340 BATTERY CLIP 50A L:100MM</p> 
<p>LH02-2321 INDOOR/OUTDOOR MATCHING TRANSFORMER</p> 	<p>LH02-2331 ALLIGATOR CLIP W/ SCREW L:50MM</p> 	<p>LH02-2341 BATTERY CLIP 50A L:100MM</p> 

LH02-2342
BATTERY CLIP 100A
L:105MM



LH02-2352



LH02-2362
BATTERY CLIPS TO
BATTERY CLIPS,
W/WIRE



LH02-2343
BATTERY CLIP, JUMBO SIZE
A: 4"
B: 6"
C: 9"
COLOR :RED, BLACK



LH02-2353



LH02-2363
JUMPER TEST LEAD SET
10 PAIRS SMALL
ALLIGATOR CLIPS
W/10 WIRES
(5 COLORS)



LH02-2344
BATTERY CLIP 100A
COLOR: RED, BLACK



LH02-2354



LH02-2364
JUMPER TEST LEAD
SET 10 PAIRS MEDIUM
ALLIGATOR CLIPS
W/10 WIRES
(5 COLORS)

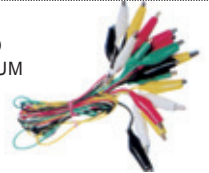

LH02-2345
BATTERY CLIP 500A
COLOR: RED, BLACK



LH02-2355



LH02-2365
JUMPER TEST LEAD
SET 5 PAIRS LARGE
ALLIGATOR CLIPS
W/5 WIRES
(5 COLORS)



LH02-2346
BATTERY CLIP 5A, W/BOOT
COLOR: BLACK, RED
L:43MM



LH02-2356



LH02-2366
TEST LEAD SET 6 PAIRS
LARGE ALLIGATOR CLIPS
W/6 WIRES
(6 COLORS)



LH02-2347
BATTERY ALLIGATOR CLIP
200A COLOR: RED, BLACK



LH02-2357
BATTERY CLIPS TO
DC PLUGS, CROSS TYPE
(W/ WIRE)
COLOR: BLACK, RED



LH02-2367
BATTERY CORD 3A
FUSE TO 2.5MM DC
PLUG
BLACK AND RED



LH02-2348
BATTERY CLIP 10A
W/BOOT
COLOR: BLACK, RED
L:54MM



LH02-2358
BATTERY CLIPS TO DC
PLUG, W/WIRE
COLOR: BLACK, RED
A: 2.1MM/5.5MM
B: 2.5MM/5.5MM



LH02-2368
BATTERY CORD 3A FUSE
TO 3.5MM MONO
PLUG



LH02-2349
BATTERY CLIP 20A, W/BOOT
COLOR: BLACK, RED
L:65MM



LH02-2359
BATTERY CLIPS TO AUTO
CIGARETTE
LIGHTER
PLUG, W/WIRE
COLOR: BLACK, RED



LH02-2369
BATTERY CORD 3A
FUSE TO
CROSS DC
PLUG



LH02-2350
BATTERY CLIP 30A
W/BOOT
COLOR: BLACK, RED
L:71MM



LH02-2360
BATTERY CLIPS TO
BATTERY CLIPS
W/WIRE
COLOR:
BLACK, RED



LH02-2370
BATTERY CORD 3A
FUSE TO RCA
PLUG



LH02-2351
BATTERY CLIP 50A
W/BOOT
COLOR: BLACK, RED
L:75MM



LH02-2361
BATTERY CLIPS
TO BATTERY CLIPS,
W/WIRE



LH02-2371
BANANA PLUG
A: NICKEL
B: GOLD



LH02-2372
BANANA PLUG
A: NICKEL
B: GOLD



LH02-2382
BANANA PLUG



LH02-2392
BANANA PLUG



LH02-2373
BANANA PLUG
A: NICKEL
B: GOLD



LH02-2383
BANANA PLUG



LH02-2393
BANANA PLUG



LH02-2374
BANANA PLUG
A: NICKEL
B: GOLD



LH02-2384
BANANA PLUG
A: NICKEL
B: GOLD



LH02-2394
BANANA PLUG



LH02-2375
BANANA PLUG
A: NICKEL
B: GOLD



LH02-2385
BANANA PLUG
A: NICKEL
B: GOLD



LH02-2395
BANANA PLUG

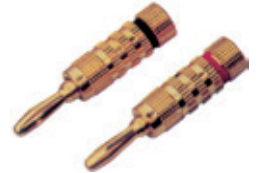

LH02-2376
BANANA PLUG
A: NICKEL
B: GOLD



LH02-2386
BANANA PLUG
A: NICKEL
B: GOLD



LH02-2396
BANANA PLUG



LH02-2377
BANANA PLUG
A: NICKEL
B: GOLD



LH02-2387
BANANA JACK



LH02-2397
BANANA PLUG

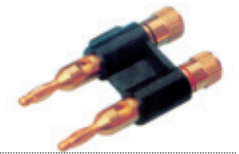

LH02-2378
BANANA PLUG
A: NICKEL
B: GOLD



LH02-2388
BANANA JACK



LH02-2398
BINDING POST
(R/B/Y/B/G)

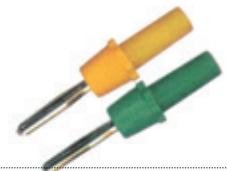

LH02-2379
BANANA PLUG
A: NICKEL
B: GOLD



LH02-2389
BANANA JACK



LH02-2399
BINDING POST



LH02-2380
BANANA PLUG
A: NICKEL
B: GOLD



LH02-2390
ARROW TIP PLUG



LH02-2400
BINDING POST



LH02-2381
BANANA PLUG
A: NICKEL
B: GOLD



LH02-2391
BANANA PLUG



LH02-2401
BANANA PLUG



LH02-2402
BANANA PLUG



LH02-2412
BINDING POST

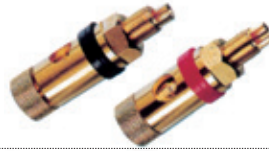

LH02-2422
BINDING POST



LH02-2403
BANANA PLUG



LH02-2413
BINDING POST



LH02-2423
BINDING POST



LH02-2404
BANANA PLUG



LH02-2414
BINDING POST



LH02-2424
BINDING POST



LH02-2405
BANANA PLUG



LH02-2415
BINDING POST



LH02-2425
BINDING POST



LH02-2406
BANANA PLUG



LH02-2416
BINDING POST



LH02-2426
BINDING POST



LH02-2407
BANANA PLUG



LH02-2417
BINDING POST



LH02-2427
BINDING POST
DOUBLE



LH02-2408
BINDING POST



LH02-2418
BINDING POST



LH02-2428
BINDING POST
DOUBLE



LH02-2409
BINDING POST



LH02-2419
BINDING POST



LH02-2429
BINDING POST
DOUBLE



LH02-2410
BINDING POST



LH02-2420
BINDING POST



LH02-2430
DOUBLE BINDING
POST TO
BNC PLUG



LH02-2411
BINDING POST



LH02-2421
BINDING POST



LH02-2431
BINDING POST



<p>LH02-2432 BINDING POST</p> 	<p>LH02-2442 CAR CIGARETTE PLUG WITH FUSE</p> 	<p>LH02-2452 1P(C*1) A.WITH 15CM LEAD WIRE B.WITH SOLDER LUG</p> 
<p>LH02-2433 BINDING POST</p> 	<p>LH02-2443 CAR CIGARETTE PLUG WITH FUSE</p> 	<p>LH02-2453 2P(C*2) A.WITH 15CM LEAD WIRE B.WITH SOLDER LUG C.WITH BATTERY CLIP</p> 
<p>LH02-2434 BINDING POST</p> 	<p>LH02-2444 CAR CIGARETTE SOCKET WITH FUSE</p> 	<p>LH02-2454 3P(C*3) A.WITH 15CM LEAD WIRE B.WITH SOLDER LUG C.WITH BATTERY CLIP</p> 
<p>LH02-2435 BINDING POST</p> 	<p>LH02-2445 CAR CIGARETTE PLUG W/FUSE</p> 	<p>LH02-2455 4P(C*4) A.WITH 15CM LEAD WIRE B.WITH SOLDER LUG C.WITH BATTERY CLIP</p> 
<p>LH02-2436 BINDING POST</p> 	<p>LH02-2446 CAR CIGARETTE PLUG TO 3XCAR CIGARETTE INLINE SOCKET L:20MM</p> 	<p>LH02-2456 4P(AA*1) A.WITH 15CM LEAD WIRE B.WITH SOLDER LUG C.WITH PIN</p> 
<p>LH02-2437 BINDING POST</p> 	<p>LH02-2447 CAR CIGARETTE PLUG TO 2XCAR CIGARETTE INLINE SOCKET L:20MM</p> 	<p>LH02-2457 2P(AA*2) A.WITH 15CM LEAD WIRE B.WITH SOLDER LUG C.WITH BATTERY CLIP</p> 
<p>LH02-2438 BINDING POST</p> 	<p>LH02-2448 1P(D*1) A.WITH 15CM LEAD WIRE B.WITH SOLDER LUG</p> 	<p>LH02-2458 2P(AA*2) A.WITH 15CM LEAD WIRE B.WITH SOLDER LUG C.WITH BATTERY CLIP</p> 
<p>LH02-2439 CAR CIGARETTE PLUG</p> 	<p>LH02-2449 2P(D*1) A.WITH 15CM LEAD WIRE B.WITH SOLDER LUG C.WITH BATTERY CLIP</p> 	<p>LH02-2459 2P(AA*2) A.WITH 15CM LEAD WIRE B.WITH SOLDER LUG C.WITH BATTERY CLIP</p> 
<p>LH02-2440 CAR CIGARETTE PLUG W/O FUSE</p> 	<p>LH02-2450 4P(D*4) A.WITH 15CM LEAD WIRE B.WITH SOLDER LUG C.WITH BATTERY CLIP</p> 	<p>LH02-2460 2P(AA*2) A.WITH 15CM LEAD WIRE B.WITH SOLDER LUG</p> 
<p>LH02-2441 CAR CIGARETTE PLUG</p> 	<p>LH02-2451 4P(D*4) A.WITH 15CM LEAD WIRE B.WITH SOLDER LUG</p> 	<p>LH02-2461 3P(AA*3) A.WITH 15CM LEAD WIRE B.WITH SOLDER LUG</p> 

LH02-4462 3P(AA*3)

- A.WITH 15CM LEAD WIRE
- B.WITH SOLDER LUG
- C.WITH BATTERY CLIP



LH02-4472 1P(AAA*1)

- A.WITH 15CM LEAD WIRE
- B.WITH SOLDER LUG
- C.WITH PIN



LH02-4482 3P(AA*3)

- A.WITH 15CM LEAD WIRE
- B.WITH SOLDER LUG
- C.WITH BATTERY CLIP



LH02-4463 4P(AA*4)

- A.WITH 15CM LEAD WIRE
- B.WITH SOLDER LUG
- C.WITH BATTERY CLIP

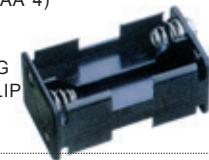

LH02-4473 1P(AAA*1)

- A.WITH 15CM LEAD WIRE
- B.WITH SOLDER LUG
- C.WITH PIN



LH02-4483 4P(AA*4)

- A.WITH 15CM LEAD WIRE
- B.WITH SOLDER LUG
- C.WITH BATTERY CLIP



LH02-4464 4P(AA*4)

- A.WITH 15CM LEAD WIRE
- B.WITH SOLDER LUG
- C.WITH BATTERY CLIP



LH02-4474 2P(AAA*2)

- A.WITH 15CM LEAD WIRE
- B.WITH SOLDER LUG

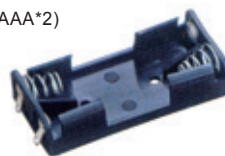

LH02-4484 2P(AAA*2)

- A.WITH 15CM LEAD WIRE
- B.WITH SOLDER LUG
- C.WITH BATTERY CLIP



LH02-4465 4P(AA*4)

- A.WITH 15CM LEAD WIRE
- B.WITH SOLDER LUG
- C.WITH BATTERY CLIP



LH02-4475 2P(AAA*3)

- A.WITH 15CM LEAD WIRE
- B.WITH SOLDER LUG
- C.WITH BATTERY CLIP

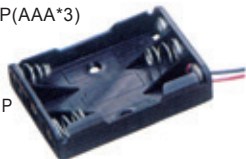

LH02-4485 3P(AAA*3)

- A.WITH 15CM LEAD WIRE
- B.WITH SOLDER LUG
- C.WITH BATTERY CLIP



LH02-4466 4P(AA*4)

- A.WITH 15CM LEAD WIRE
- B.WITH SOLDER LUG



LH02-4476 4P(AAA*4)

- A.WITH 15CM LEAD WIRE
- B.WITH SOLDER LUG
- C.WITH BATTERY CLIP



LH02-4486 4P(AAA*4)

- A.WITH 15CM LEAD WIRE
- B.WITH SOLDER LUG
- C.WITH BATTERY CLIP



LH02-4467 6P(AA*6)

- A.WITH 15CM LEAD WIRE
- B.WITH SOLDER LUG
- C.WITH BATTERY CLIP

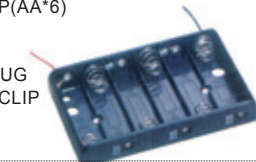

LH02-4477 4P(AAA*4)

- A.WITH 15CM LEAD WIRE
- B.WITH SOLDER LUG
- C.WITH PIN

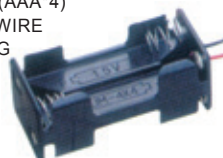

LH02-4487 9V BATTERY CLIP, I TYPE

- A.WITH 15CM LEAD WIRE
- B.WITH SOLDER LUG
- C.WITH BATTERY CLIP



LH02-4468 6P(AA*6)

- A.WITH 15CM LEAD WIRE
- B.WITH SOLDER LUG
- C.WITH BATTERY CLIP



LH02-4478 1P(N*1)

- A.WITH 15CM LEAD WIRE
- B.WITH SOLDER LUG



LH02-4488 9V BATTERY CLIP, T TYPE

- A.WITH 15CM LEAD WIRE
- B.WITH SOLDER LUG
- C.WITH BATTERY CLIP



LH02-4469 8P(AA*8)

- A.WITH 15CM LEAD WIRE
- B.WITH SOLDER LUG
- C.WITH BATTERY CLIP



LH02-4479 2P(N*2)

- A.WITH 15CM LEAD WIRE
- B.WITH SOLDER LUG



LH02-4489 9V BATTERY CLIP, T TYPE

- A.WITH 15CM LEAD WIRE
- B.WITH SOLDER LUG
- C.WITH BATTERY CLIP



LH02-4470 8P(AA*8)

- A.WITH 15CM LEAD WIRE
- B.WITH SOLDER LUG
- C.WITH BATTERY CLIP

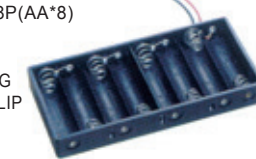

LH02-4480 1P(AA*1)

- A.WITH 15CM LEAD WIRE
- B.WITH SOLDER LUG
- C.WITH BATTERY CLIP



LH02-4490 9V BATTERY CLIP, T TYPE

- A.WITH 15CM LEAD WIRE
- B.WITH SOLDER LUG
- C.WITH BATTERY CLIP



LH02-4471 8P(AA*8)

- A.WITH 15CM LEAD WIRE
- B.WITH SOLDER LUG
- C.WITH BATTERY CLIP

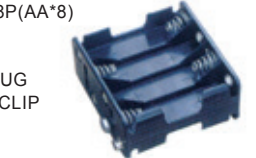

LH02-4481 2P(AA*2)

- A.WITH 15CM LEAD WIRE
- B.WITH SOLDER LUG
- C.WITH BATTERY CLIP



LH02-4491 9V BATTERY CLIP, T TYPE

- A.WITH 15CM LEAD WIRE
- B.WITH SOLDER LUG
- C.WITH BATTERY CLIP



<p>LH02-4492 9V BATTERY CLIP, T TYPE</p> 	<p>LH02-4502 LINGHT SET</p> 	<p>LH02-4512 SCART PLUG TO 3RCA JACK W/SWITCH</p> 
<p>LH02-4493 9V BATTERY CLIP, T TYPE</p> 	<p>LH02-4503 SCART PLUG</p> 	<p>LH02-4513 SCART PLUG TO 3RCA JACK IN</p> 
<p>LH02-4494 9V BATTERY CLIP, T TYPE</p> 	<p>LH02-4504 SCARTJACK</p> 	<p>LH02-4514 SCART PLUG TO 3RCA JACK AND 1 MINI 4 P JACK W/SWITCH</p> 
<p>LH02-4495 9V BATTERY CLIP, T TYPE</p> 	<p>LH02-4505 SCART PLUG AUDIO/ VIDEO OUT</p> 	<p>LH02-4515 SCART PLUG TO 3RCA JACK AND MINI 4 P JACK IN</p> 
<p>LH02-4496 9V BATTERY CLIP,</p> 	<p>LH02-4506 SCART PLUG METAL, GOLD</p> 	<p>LH02-4516 SCART PLUG TO 3RCA JACK W/SWITCH</p> 
<p>LH02-4497 BATTERY SEAT, FOR CR1220 BATTERY</p> 	<p>LH02-4507 SCART PLUG TO 2RCA JACK IN</p> 	<p>LH02-4517 SCART PLUG TO 3RCA JACK AND 1 MINI 4 P JACK W/ SWITCH</p> 
<p>LH02-4498 BATTERY SEAT, FOR CR2016 BATTERY</p> 	<p>LH02-4508 SCART PLUG TO 2RCA JACK W/SWITCH</p> 	<p>LH02-4518 SCART PLUG TO 3RCA JACK W/ SWITCH</p> 
<p>LH02-4499 BATTERY SEAT, FOR CR2025 BATTERY</p> 	<p>LH02-4509 SCART PLUG TO 3RCA JACK OUT</p> 	<p>LH02-4519 SCART PLUG TO 3RCA JACK AND 1 MINI 4P JACK W/ SWITCH</p> 
<p>LH02-4500 BATTERY SEAT, FOR CR2032 BATTERY</p> 	<p>LH02-4510 SCART PLUG TO 3RCA JACK IN</p> 	<p>LH02-4520 SCART PLUG TO 3RCA JACK AND 1 MINI 4P JACK W/ SWITCH</p> 
<p>LH02-4501 BATTERY SEAT, FOR CR2430 BATTERY</p> 	<p>LH02-4511 SCART PLUG TO 3RCA JACK W/SWITCH</p> 	<p>LH02-4521 21PIN PLUG TO 3RCA JACK AND 1 S-VHS JACK WITH SWITCH, METALIZED HOUSING</p> 

LH02-4522
SCART PLUG TO
3RCA JACK AND 1
MINI 4P JACK
W/ SWITCH



LH02-4532
GAME SELECTOR
1-3



LH02-4541
AV-SWITCH S-VHS



LH02-4523
SCART PLUG TO
3RCA JACK OUT



LH02-4533
GAME SELECTOR
1-4



LH02-4524
SCART PLUG TO
3X RCA JACK
AND 1 MINI 4P JACK
W/ SWITCH



LH02-4534
BETA TRANSPARENT
GAME SELECTOR
A:BLUE B:YELLOW
C:GREEN D:RED
E:BLACK F:PINK

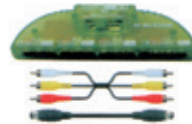

LH02-4542
SCART PLUG TO
2XSCART JACK
0.5M CABLE



LH02-4525
SCART PLUG TO SCART
JACK AND 3X RCA JACK
AND 1 MINI 4P JACK
W/ SWITCH



LH02-4535
BETA TRANSPARENT
GAME SELECTOR
A:BLUE B:YELLOW
C:GREEN D:RED
E:BLACK



LH02-4526
SCART PLUG TO SCART
JACK AND 3X RCA
JACK IN



LH02-4536
BETA TRANSPARENT
GAME SELECTOR
A:BLUE B:YELLOW
C:GREEN D:RED
E:BLACK



LH02-4543
SCART PLUG TO
3XSCART JACK
0.5M CABLE



LH02-4527
SCART PLUG TO
SCART JACK
AND 3X RCA
JACK OUT



LH02-4537
GAME SELECTOR
1-3



LH02-4528
SCART ADAPTER
SCART PLUG TO 2RCA
JACKS
(AUDIO IN)



LH02-4538
GAME SELECTOR
1-3 WITH S-VHS
SOCKET



LH02-4544
SCART PLUG TO
5XSCART JACK
0.5M CABLE



LH02-4529
SCART ADAPTER
SCART PLUG TO
3RCA JACKS
(AUDIO OUT)



LH02-4539
SPEAKER DISTRIBUTION
BOX



LH02-4530
SCART ADAPTER
SCART PLUG TO 2RCA
JACKS(AUDIO IN)



LH02-4540
SCART SWITCH BOX3
SCART INPUT JACK,
1 SCART OUTPUT
JACK
W/4 RCA SOCKETS



LH02-4545
21PIN SCART PLUG TO 2X21PIN
SCART JACKS AND 2RCA JACKS
BOX W/SWITCH
O.D.:8.0MM L:0.5M



LH02-4531
SCART ADAPTER
SCART PLUG TO 3RCA
JACKS(AUDIO IOUT)



LH02-4546

21PIN SCART PLUG TO 2X21PIN SCART JACKS AND 3RCA JACKS BOX
O.D.:8.0MM L:0.5M



LH02-4552

21 PIN SCART PLUG TO 5X21PIN SCART JACKS WITH 3RCA+S-VIDEO+SWITCH



LH02-4558

SCART PLUG-5XSCART SOCKETS WITH SWITCH



LH02-4547

21PIN SCART PLUG TO 2X21PIN SCART JACKS AND 3RCA JACKS BOX W/SWITCH
O.D.:8.0MM L:0.5M



LH02-4553

SCART PLUG-2XSCART SOCKETS WITH SWITCH



LH02-4548

21PIN SCART PLUG TO 2X21PIN SCART JACKS AND 3RCA JACKS AND 1 MINI 4PIN JACK
O.D.:8.0MM L:0.5M



LH02-4554

SCART PLUG-2XSCART SOCKETS WITH 2RCA JACKS



LH02-4549

21PIN SCART PLUG TO 2X21PIN SCART JACKS AND 3RCA JACKS AND 1 MINI 4PIN JACK W/SWITCH
O.D.:8.0MM L:0.5M



LH02-4555

SCART PLUG-2XSCART SOCKETS WITH 3RC AND S-VHS JACKS WITH SWITCH



LH02-4550

21 PIN SCART PLUG TO 3X21PIN SCART JACKS AND 2RCA JACKS (W/SWITCH)
O.D.:8.0MM L:0.5M

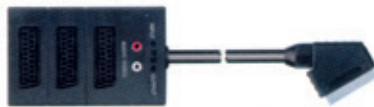

LH02-4556

SCART PLUG-3XSCART SOCKETS



LH02-4551

21 PIN SCART PLUG TO 3X21PIN SCART JACKS 3 RCA JACKS AND 1 MINI 4 PIN JACK (W/SWITCH)
OD.:8MM L:0.5M



LH02-4557

SCART PLUG-3XSCART SOCKETS WITH 3RCA AND S-VHS JACKS WITH SWITCH

