



AKSO
爱可多健康科技
AKSOHEALTHCARE

**Safe. Clean.
Comfortable**

北京爱可多健康科技有限公司

地址:北京市丰台科技园星火路1号昌宁大厦2L
电话:86-10-57273220
传真:86-10-62669828
网站:www.aksohealthcare.en.alibaba.com
邮箱:sales@aksohealthcare.com

Beijing Akso Healthcare Co.,Ltd

Address:2L, Changning Building, NO.1 Xinghuo Road, Fengtai Science Park, Beijing, China
Tel:86-10-57273220
Fax:86-10-62669828
Http:www.aksohealthcare.en.alibaba.com
E-mail:sales@aksohealthcare.com



BEIJING AKSO HEALTHCARE CO.,LTD

Company Profile

Alice, founder of Akso healthcare, whose grandfather was a famous Chinese doctor. He had helped many people with his medical skills. From early childhood, Alice learned from her grandfather that medical work endures no carelessness.

Alice entered medical industry after growing up, and found Akso healthcare. Rigorous, safe, clean and comfort have accompanying all her work. This is the pursuit of Alice and her team. From design, choosing raw materials to production process, Akso has always been strict and aims to providing best quality products. That is why the company is named Akso healthcare. We want to uphold the spirit of Akso, to provide users with a better use experience.

Akso healthcare specialize in medical disposables, protective apparel, and nonwoven disposable products. Such as surgical draps, gowns, packs, disposable coverall, isolation gown, face mask, shoe cover etc. We have 8 cooperative plants and will build our factory this year. All that cooperative plants strictly follow the requirement and procedures of ISO 13485/ CE/ FDA, all products made in FULLGUARD are in conformity with international standards and statutory regulations. Now our factories are covering 50000 square meters, with more than 700 skillful workers. The production capacity is about 30x40HQ container per month. Our products has been exported to Europe, North America and Middle East, Such as USA, Canada, France, Germany, Italy, Japan, Korea, Israel, Iran, Saudi Arabia and so on.







Choose us, trust us and let's work together, for life and for health.



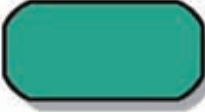

目录 CONTENTS

手术衣	Surgical Gown	1-2
通用类手术	General Surgery	3-6
整形类手术	Orthopaedics	7-15
妇产类手术/泌尿类手术	Gynaecology,Obstrics&Urology	16-23
眼科类手术/耳鼻喉类手术	Ophthalmology&ENT	24-29
神经类手术	Neurology	30-31
心脏类/心血管类手术	Cardiovascular&Angiography	32-39
牙科手术	Dental	40-42
设备仪器罩	Equipment Cover	43-44
配件/附件	Accessories	45-48
防护类产品	Protective Products	49-56

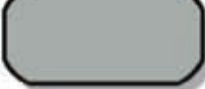
	SMS/SMMS Drapes
	Dual Layer Drapes
	Elastic material Drapes
	Blue plastic material Drapes
	Transparent plastic material Drapes
	Incision film Drapes
	Medical tape Drapes
	Towel

Material key

Our material

All Beijing Akso materials fulfil the standard EN 13795, such as low number of particles, absorption capability, impermeability to micro-organisms and tear strength are more than fulfilled. We co-operate with certified suppliers, and you can be certain that the products used by them are subject to high quality standards.



SMS, SMMS, SMMMS material

SMS, SMMS, SMMMS material is composed of 2 layers of spunbonded fabric and 2 layers of Melt blown fabric. The polypropylene fibres have the advantage of building barriers against bacteria and repelling blood and other liquids. With good tensile strength, high filtration, lint-free, breathable, Material can be with Anti-alcohol, anti-blood, anti-static, anti-oil and softness treatment
 Application: Gowns & Drapes, Sterilization Wrap



Spunlace material

Spunlace nonwoven consist of a fleece material, structure due to its skin comfort with its soft texture, smooth surface, lint-free, high wearing comfort, breathable, tear-proof, against bacteria and repelling blood and other liquids. High repellent esp. against bacterial transmission.
 Application: Gowns & Drapes, Towel



Dual-layer material

With its absorbing and liquid trapping property double layer material has become more widespreadly. During the surgery, the top layer is highly absorbent material, quickly absorbs any type of liquid that comes onto the cloth and PE film creating the bottom layer prevents absolute liquid penetration. Its high barrier against bacteria, impermeability to blood and other liquids, lint-free, good drapability. Regular two style: 1. Absorbent PP + PE, 2. Absorbent Viscose + PE.
 Application: Drapes, Equipment Cover, Reinforced Area



Trilaminate material

A combination of Spunbond PP+PE film + Absorbent viscose., absorbent in top layer, fully liquid resistant in middle layer and PP fabric in contact with patient's skin, which is meant to prevent hypothermia of the patient during long operations. Its high barrier against bacteria, impermeability to blood and other liquids, lint-free, good drapability.
 Application: Drapes

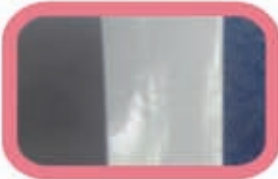

Medical Tape

Medical tapes which have non-irritating characteristic to skin, are used for securing the cloth to the patient's skin or for creating a barrier around the surgery zone. It minimizes the microorganism transfer from or to the surgery zone



Incise Film

Incise film layer which has non-irritating characteristic to skin, helps to maintain good adhesion by adding it in between the clothes during surgery or by using it alone in the surgery zone. It also creates a barrier against infections.

手术衣

SURGICAL GOWNS



Knitted cuff



Over-locking



Double sewing



Ultrasonic

Beijing Akso gowns has designed with safety,comfort and flexibility.We offer different fabrics which can meet EN13795 and AAMI Level3& Level4 performance requirements.

The variety of different material and models give you an option to choose the right gown for comfortable and protected procedure.Wide range of Surgical Gowns provides the advanced solution in deferent levels of protection to help protect patients and staff from the spread of infection during Surgery

Performance

- ⊙ Fluid Repellent
- ⊙ High Barrier performance
- ⊙ Cool and Breathable
- ⊙ Low Lint
- ⊙ Latex Free
- ⊙ Adjustable Velcro Neck Fastners
- ⊙ Raglan Sleeves
- ⊙ Knitted Cuffs
- ⊙ Sterile gown is packed with 2towels in a paper wrap and peelable bag

Standard Surgical Gown 标准手术衣

Size	REF	L(cm)	W(cm)
M	GS010	115	150
L	GS011	125	157
XL	GS012	140	165
XXL	GS013	155	170



Reinforced Surgical Gown 加强型手术衣

Size	REF	L (cm)	W (cm)
M	GS010	115	150
L	GS011	125	157
XL	GS012	140	165
XXL	GS013	155	170



T.U.R Surgical Gown 泌尿科手术衣

Size	REF	L (cm)	W (cm)
XL	GT011	150	180



通用类手术

GENERAL SURGERY



General Pack



Universal Pack

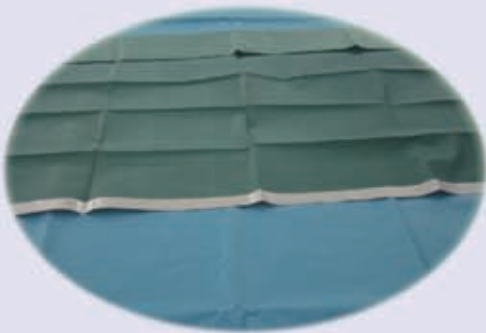

Adhesive Drape

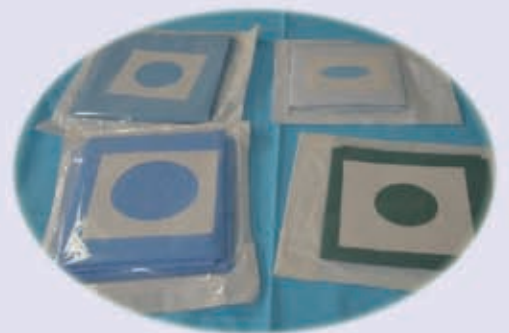

Fenestrated Drape



Laparotomy Drape



Fenestrated Drape

Universal Pack(AK:10101)

通用手术包

No.	REF	Description	QTY
1	8201	Back Table Cover 140x190cm	1
2	8102	Mayo Stand Cover 78x145cm	1
3	11402	Adhesive Side Drape 75x90cm	2
4		Adhesive Bottom Drape 150x180cm	1
5		Adhesive Top Drape 150x240cm	1
6	90201	Hand Towel 30x40cm	4
7	90301	OP Tape Strip 10x50cm	1
8	GR011	Reinforced Surgical Gown, Lsize	2

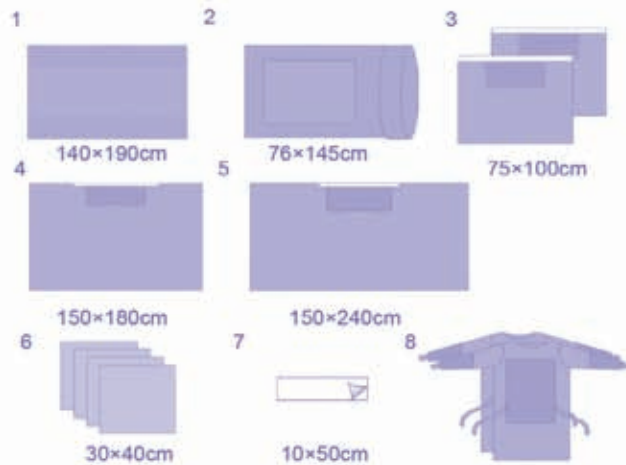

Single Plain Drape

简易铺单

Size	REF
45x75cm	11001
60x60cm	11002
75x90cm	11003
120x150cm	11004



Adhesive Side Drape

贴胶边单

Size	REF
50x50cm	11401
75x90cm	11402
90x90cm	11403
100x150cm	11404
120x150cm	11405



Fenestrated Drape without Tape

洞巾不贴胶

REF	Size	Fenestration
11501	50x50cm	Central Dia.7cm
11502	75x90cm	Central Oval 6x9cm
11503	90x90cm	Central Rectangular 10x12cm
11504	100x150cm	10x15cm Hole
11505	120x150cm	Central Square 10x10cm

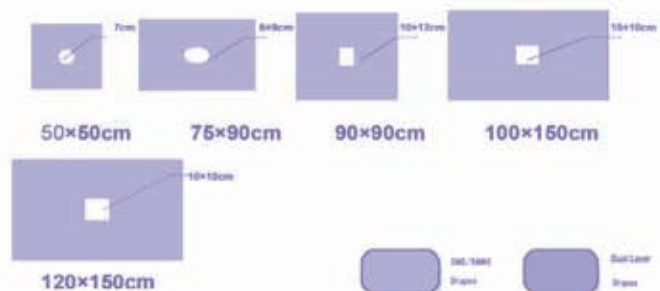

GENERAL SURGERY 通用类手术

Fenestrated Drape with Tape
洞巾贴胶

REF	Size	Fenestration
11601	50x50cm	Central Dia.7cm,with tape
11602	75x90cm	Central Oval 6x9cm,with tape
11603	90x90cm	Central Rectangular 10x12cm,with tape
11604	100x150cm	Central Square 10x10cm,with tape
11605	120x150cm	Central Rectangular 12x15cm,with tape

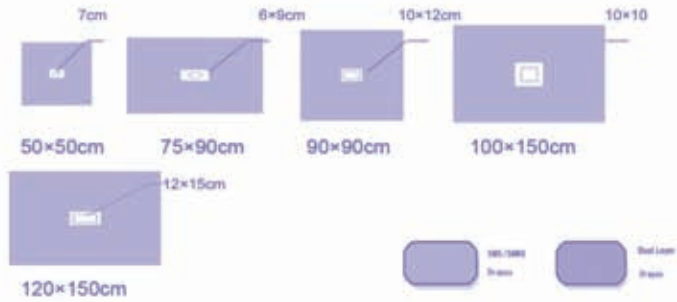

Laparoscopy Pelviscopy Pack
(AK:10201) 腹腔镜手术包

No.	REF	Description	QTY
1	8201	Back Table Cover 140x190cm	1
2	8102	Mayo Stand Cover78x145cm	1
3	11201	Laparoscopy Drape,195x250x300cm,reinforcement 100x75cm,with 25x30cm fenestration, 5cm adhesive around,Perineal fenestration 20x10cm,with 2.5cm tape,with flap over both fenestration	1
4	90301	Suture Bag	1
5	90201	Hand Towel30x40cm	4
6	GR01	Reinforced Surgical Gown,L size	2

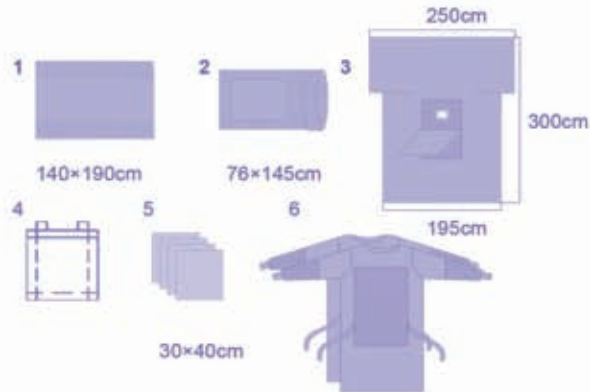

Laparoscopy Drape 腹腔镜手术单

REF	Size(cm)	Description
11201	195x250x300cm	T shape,Absorbent reinforcement area 100x75cm,with 25x30cm fenestration,5 cm adhesive around,Perineal fenestration 20x10cm,with 2.5cm tape,with flap over both fenestration
11202	200x260x310	T shape,Absorbent reinforcement area 100x75cm,with 25x30cm adhesive fenestration,2 instrument pouch,4 Velcro tube holders

Times New Roman

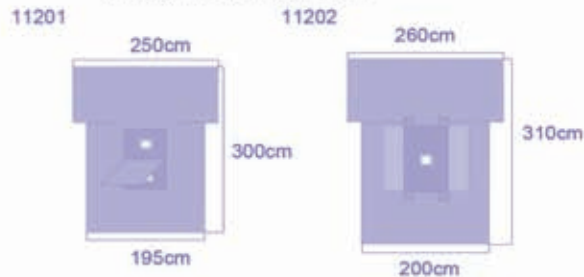

Laparotomy Pack(AK:10301)
腹部手术包

No.	REF	Description	QTY
1	8201	Back Table Cover 140x190cm	1
2	8102	Mayo Stand Cover78x145cm	1
3	11301	Laparoscopy Drape,195x250x300cm,reinforcement 100x75cm,with 25x30cm fenestration,5cm adhesive around,Perineal fenestration 20x10cm,with 2.5cm tape,with flap over both fenestration	1
4		Utility Drape with Adhesive 38x66cm	4
5		1/2 Drape 102x147cm	2
6	90301	Suture Bag	1
7	90201	Hand Towel30x40cm	4
8	GR01	Reinforced Surgical Gown,L size	2

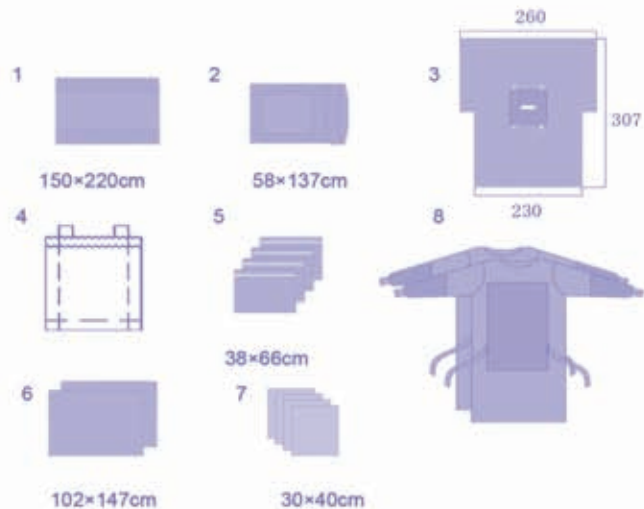

Laparotomy Drape

腹部手术单

REF	Size(cm)	Description
11301	307x260x200	With armboard, Fabric reinforcement 75x75cm, with 10x30cm Fenestration, 2.5cm adhesive around, tube holders
11302	300x230	Fabric reinforcement 75x80cm, with 12x25cm Fenestration, 2.5cm adhesive around

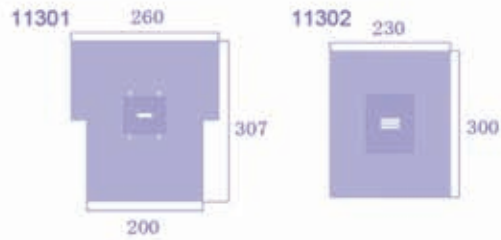

Thyroid(Struma)Drape

甲状腺手术单

REF	Size(cm)	Description
11701	190x300	Absorbent area 50x40cm, with Diamound fenestration 12x12cm, 2.5cm adhesive around, 3tube holders

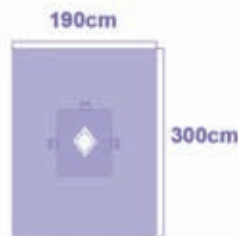

Split Drape Pack(AK:10401)

开叉手术包

No.	REF	Description	QTY
1	8201	Back Table Cover 140x190cm	1
2	8102	Mayo Stand Cover 78x145cm	1
3		Adhesive Top Drape, 150x240cm, reinforcement 40x60cm	1
4		U split drape, 190x300cm, split 20x80cm, with 5cm adhesive and absorbent #2x120cm tube holder	1
5	90301	Suture Bag	1
6	90201	Hand Towel 30x40cm	4
7	GR011	Reinforced Surgical Gown, L	2

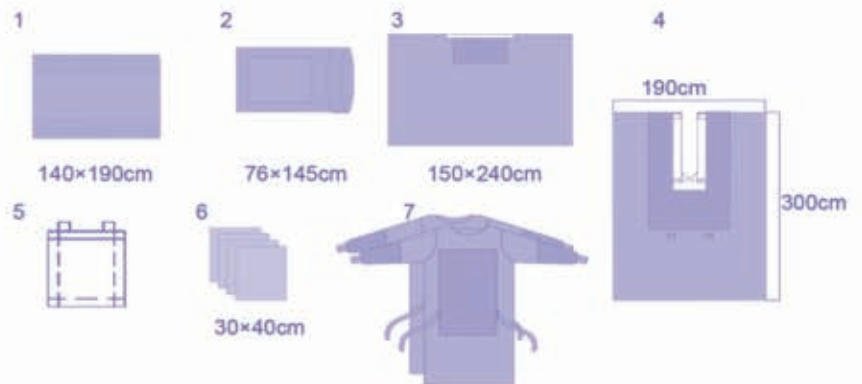

整形类手术

ORTHOPAEDICS

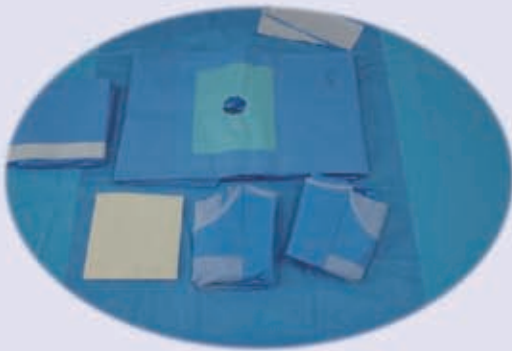

Hip Pack



Extremity Drape

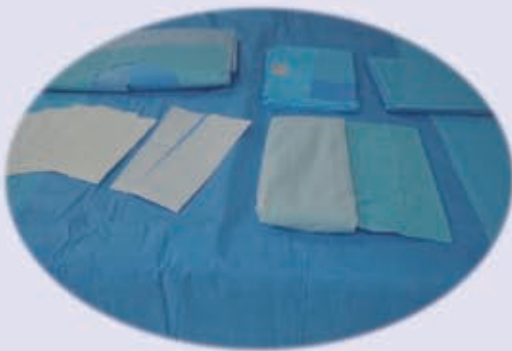

Orthopaedic Pack

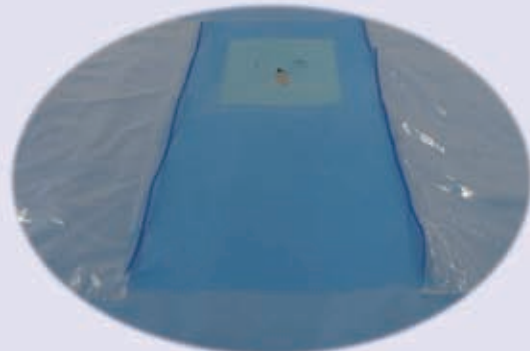

Hip Drape



Shoulder Arthroscopy Drape

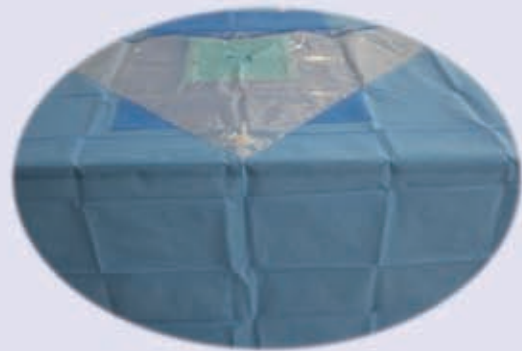

Knee Arthroscopy Pack



Orthopaedic Procedure Pack Arthroscopy Surgical Pack(AK:20502)

Quantity	Product Description
1	18g HYPODERMIC NEEDLE(1 1/2" 38mm Pink Blunt)
1	21g HYPODERMIC NEEDLE (1 1/2" 38mm Green)
1	11 BLADE
2	SYRINGE 10ML L/L
5	RAYTEC-GAUZE X-RAY 8PLY 5 PER BAG 10X10CM
1	NEEDLE MAT MAGNET DOUBLE
2	DRESSING CREPE BANDAGE 15CMx1.5M
1	DRESSING VELBAND 15CMx2.7M
2	SUCTION TUBING 4.5M
1	LINE ARTHROSCOPY FLUSHING SET
5	OR SPONGE SMALL 22.5x22.5cm,6ply
2	GALLIPOT 150ML CLEAR
1	KIDNEY DISH 700ML YELLOW
1	KIDNEY DISH 700ML CLEAR
1	BLADESAFE
1	DRAPE BACK TABLE COVER HD 152X228CM
1	STOCKINETTE LARGE 31x122cm
1	DRAPE IMPERVIOUS SPLIT 152.5x205.5cm
1	DRAPE THREE QUARTER 200x200cm
1	LOWER EXTREMITY DRAPE 220X333cm
1	DRAPE BACK TABLE COVER HD 152X228CM



Orthopaedic Procedure Pack Shoulder Surgical Pack(AK:20201)

Quantity	Product Description
1	BLADE No.11
1	HYPODERMIC NEEDLE 18g
1	HYPODERMIC NEEDLE 21g
1	SPINAL NEEDLE 19G
1	SYRINGE 20ML L/L
5	RAYTEC-GAUZE X-RAY 8PLY 5 PER BAG 10X10CM
1	NEEDLE MAT MAGNET DOUBLE
2	DRESSING COMBINE 20X20CM
1	DRESSING CREPE BANDAGE 15CM
3	SUCTION TUBING 4.5M
5	OR SPONGE SMALL 22.5x22.5cm 6ply
2	GALLIPOT 150ML CLEAR
1	KIDNEY DISH 700ML YELLOW
1	KIDNEY DISH 700ML CLEAR
1	BLADESAFE
1	DRAPE MAYO COVER XL 80x150cm
2	DRAPE IMPERVIOUS SPLIT 152.5x205.5cm
1	DRAPE SQUARE 90x90cm
1	DRAPE THREE QUARTER 200x200cm-50gsm
1	DRAPE BODY SPLIT SHOULDER,196X290cm
1	DRAPE SHOULDER ARTHROSCOPY 157x254cm
1	DRAPE BACK TABLE COVER 152X228CM HD REINFORCED
1	DRAPE BACK TABLE COVER 152X229CM HD REINFORCED



Orthopaedic Procedure Pack Hand Surgical Pack(AK:20302)

Quantity	Product Description
1	HYPODERMIC NEEDLE 18G (1 ½" 38mm Pink Blunt)
1	HYPODERMIC NEEDLE 25G (5/8" 16mm Orange)
2	BLADE No.15
1	SYRINGE 5ml L/L
1	SYRINGE 30ml SLIP TIP
10	RAYTEC –GAUZE 10x10cm 8ply
1	NEEDLE MAT MAGNET DOUBLE
1	SKIN MARKER
5	OR SPONGE SMALL 22.5x22.5cm,6ply
1	BLADESAFE
2	TOWEL BLUE LINEN 42x66cm
1	DRAPE MAYO COVER X-Large 80x150cm
1	DRAPE THREE QUARTER 200x200cm
1	DRAPE HAND --190x292x370cm
1	DRAPE BACK TABLE COVER 152X228CM HD
3	GALLIPOTS--150ml
2	KIDNEY DISH 700ml CLEAR
1	KIDNEY DISH 700ml YELLOW
1	DRAPE BACK TABLE COVER 152X228CM HD
1	BLADESAFE



Orthopaedic Procedure Pack JOINT REPLACEMENT Surgical Pack(AK:20702)

Quantity	Product Description
3	19g SPINAL NEEDLE (3 x 1/2 ")
1	BLADE No.10
1	BLADE No.20
3	SYRINGE L/L 30ML
10	RAYTEC-GAUZE X-RAY 8PLY 5 PER BAG 10X10CM
1	NEEDLE MAT MAGNET DOUBLE
1	SPATULA PLASTIC BLUE 20CM
1	DRESSING COMBINE 20X20CM
1	DIATHERMY COATED BLADE
1	SYRINGE 50ML BULB IRRIGATION
2	SUCTION TUBING SPECIAL SOFT 4M
15	OR SPONGE LARGE 50x30cm,6ply
4	GALLIPOT 150ML CLEAR
2	KIDNEY DISH 700ML YELLOW
1	KIDNEY DISH 700ML CLEAR
2	KIDNEY DISH 1500ML CLEAR
1	BLADESAFE
1	BOWL CEMENT
1	JUG 1200ML CLEAR
2	TOWEL BLUE LINEN 42X66CM
2	DRAPE BACK TABLE COVER HD 152X228CM
2	DRAPE MAYO COVER 75X145CM(Large)
1	DRAPE MAYO COVER 80x150cm(X-Large)
1	TAPE OPERATION 10X55CM
1	DRAPE IMPERVIOUS SPLIT 152.5x205.5cm
1	DRAPE SIDE REINF SMALL 100X195CM
2	DRAPE SIDE REINF 150X195CM
1	2 INCH GAUZE STRIP x1.5m
1	CATHETER Y SUCTION 12FGX43CM

Extremity Pack with gown(AK:20101)

四肢手术包

No.	REF	Description	QTY
1	8201	Back Table Cover 140x190cm	1
2	8102	Mayo Stand Cover78x145cm	1
3	21101	Extremity Drape,220x320cm	1
4		Utility Drape,75x75cm	1
5		OP Tape Strip,10x50cm	1
6		Impervious Split Drape,140x175cm,10x50cm,U cut Adhesive Split	1
7	90201	Hand Towel,30x40cm	4
8	GR012	Reinforced Surgical Gown with 2pcs hand towel,XL	2

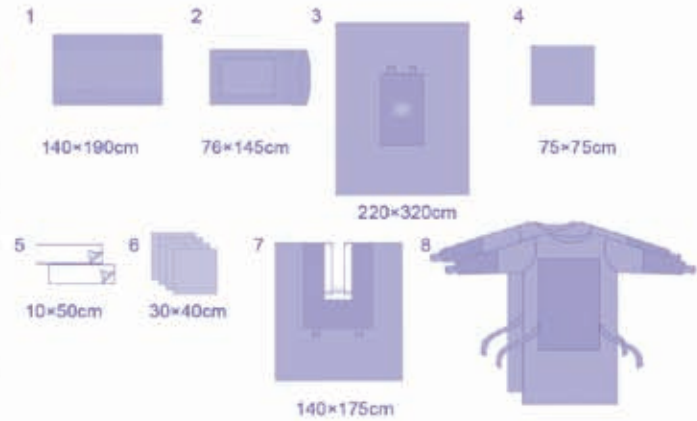

Shoulder Beach Chair Drape

肩关节镜手术单

REF	Size(cm)	Description
21201	260x400	Reinforcement 75x50cm, Elastic fenestration 6cm, Fluid collection pouch 75x90cm with 1 valve, 2 Velcro Tube holders

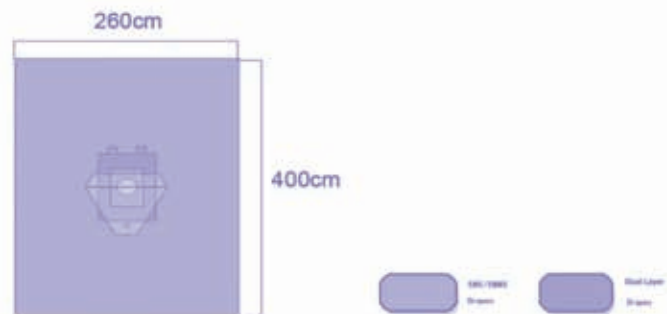

Shoulder Arthroscopy Drape

肩关节镜手术单

REF	Size(cm)	Description
21202	250x160	Split 15x50cm, Fluid collection pouch 27x115cm with 2 valve, Tape 5cm



ORTHOPAEDICS 整形类手术

Hand Pack with Gown(AK:20301)

手部手术包

No.	REF	Description	QTY
1	8201	Back Table Cover 140x190cm	1
2	8102	Mayo Stand Cover78x145cm	1
3	21301	Hand Drape 270x300x160cm, Elastic fenestration 18x18cm with opening Dia.3cm, Absorbent reinforcement 50x80cm	1
4	11404	Medium Drape with Adhesive, 100x150cm	1
5	90301	OP Tape Strip,10x50cm	2
6	90201	Hand Towel30x40cm	4
7	GR012	Reinforced Surgical Gown with	2

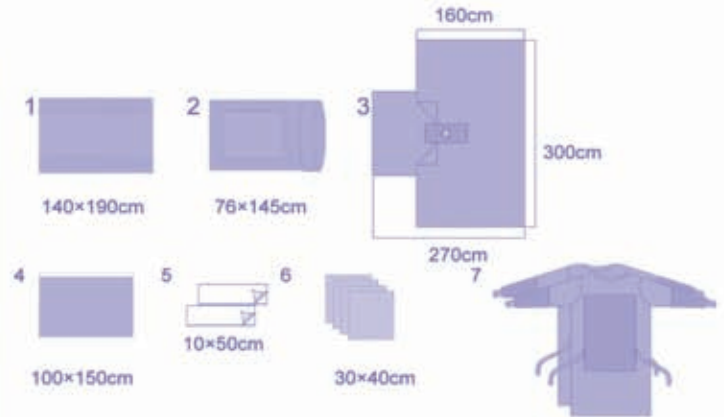

Hand Drapes

手部手术单

REF	Size(cm)	Description
21301	270x330x160	Elastic fenestration 18x18cm with opening Dia.3cm, Absorbent reinforcement 50x80cm, Gusseted hand table extension 160x90cm, Tube Holder



Hand & Foot Pack with Gown

(AK:20301) 手部足部手术包

No.	REF	Description	QTY
1	8201	Back Table Cover 140x190cm	1
2	8102	Mayo Stand Cover78x145cm	1
3	21401	Hand & Foot Drape 180x300cm, Elastic fenestration 18x18cm with opening Dia.3cm, Absorbent reinforcement 50x140cm	1
4	11404	Medium Drape with Adhesive, 100x150cm	1
5	90301	OP Tape Strip,10x50cm	2
6	90201	Hand Towel30x40cm	4
7	GR012	Reinforced Surgical Gown with 2pcs hand towel,XL	2

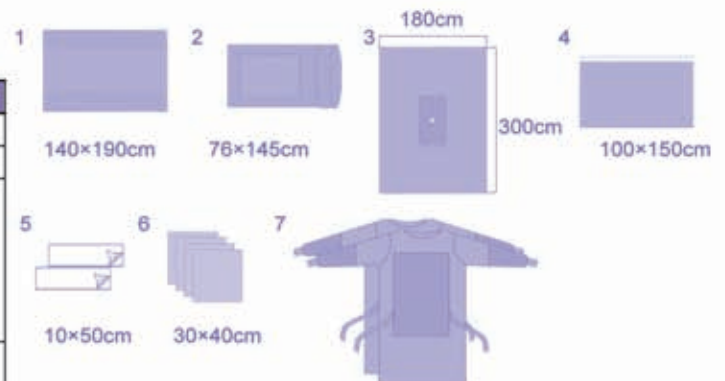

Hand & Foot Drape

手部足部手术单

REF	Size(cm)	Description
21401	180x300	Elastic fenestration 18x18cm with opening Dia.3cm, Absorbent reinforcement 50x140cm



Knee Arthroscopy Pack with Gown

(AK:20501)

膝关节镜手术包

No.	REF	Description	QTY
1	8201	Back Table Cover 140x190cm	1
2	8102	Mayo Stand Cover 78x145cm	1
3	21501	Arthroscopy T Drape 220x280x290cm, Fluid collection pouch 83x78cm, Circular Elastic fenestration 6cm, Absorbent reinforcement 75x120cm	1
4		Suture Bag	1
5	90301	OP Tape Strip, 10x50cm	2
6	90201	Hand Towel 30x40cm	4
7	GR012	Reinforced Surgical Gown with 2pcs hand towel, XL	2

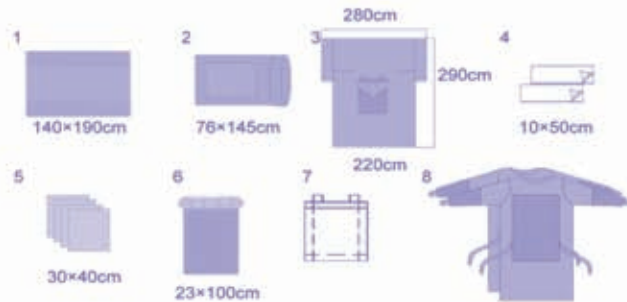

Knee Arthroscopy Drape with Armboard Cover 膝关节镜手术单

REF	Size(cm)	Description
21501	220x280x290	Absorbent Reinforcement 75x120cm, Circular Elastic fenestration Dia.6cm(Superior), Circular Elastic fenestration Dia.4cm(Inferior), Fluid collection pouch 83x78cm with 2 valve and flexwires, 2 Tube holders

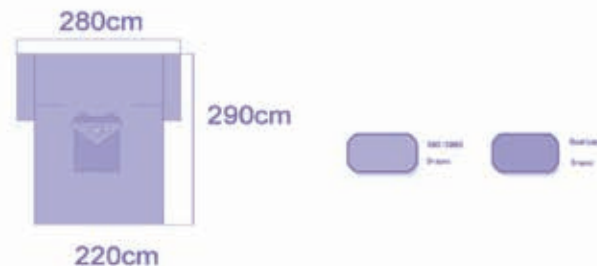

Knee Arthroscopy Drape

膝关节镜手术单

REF	Size(cm)	Description
21502	220x320	Absorbent Reinforcement 75x120cm, Circular Elastic fenestration Dia.6cm(Superior), Circular Elastic fenestration Dia.4cm(Inferior) Fluid collection pouch 60x115cm with 2 valve and flexwires, 3 Tube holders



Hip Pack with Gown(AK:20601)

髋部手术包

No.	REF	Description	QTY
1	8201	Back Table Cover 140x190cm	1
2	8102	Mayo Stand Cover 78x145cm	1
3	21601	Hip Drape 250x290x320cm	1
4		Suture Bag	1
5	90301	OP Tape Strip 10x50cm	2
6	90201	Hand Towel 30x40cm	4
7	90103	Impervious Stockinette, Medium 23x100cm	1
8	GR012	Reinforced Surgical Gown with 2pcs hand towel, XL	2

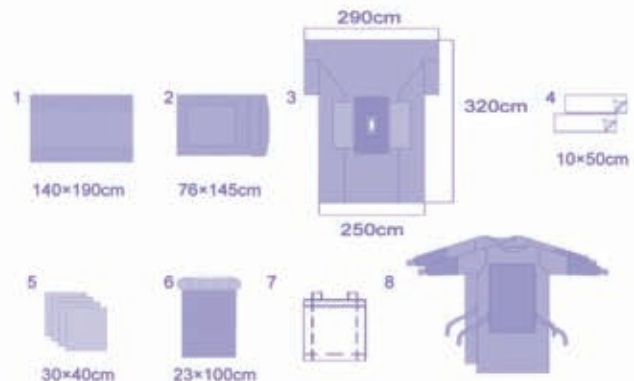

Hip Drape with Pouch

臀部手术单

REF	Size(cm)	Description
21601	250x290x326	Armboard Cover, Absorbent Reinforcement 75x120cm, Teardrop Elastic fenestration 20x17cm, Fluid collection pouch 60x120cm with 2 valve and flexwires, Tube holders



Orthopaedic Pack with Gown(AK:20701)

整形手术包

No.	REF	Description	QTY
1	8201	Back Table Cover 140x190cm	1
2	8102	Mayo Stand Cover 78x145cm	1
3	21702	Ortho U Split Drape 200x300cm	1
4		Suture Bag	1
5	90301	OP Tape Strip, 10x50cm	2
6	90201	Hand Towel 30x40cm	4
7	90103	Impervious Stockinette, Medium 23x100cm	1
8	21701	Impervious Split Drape, 150x180cm	1
9	GR012	Reinforced Surgical Gown with 2pcs hand towel, XL	2

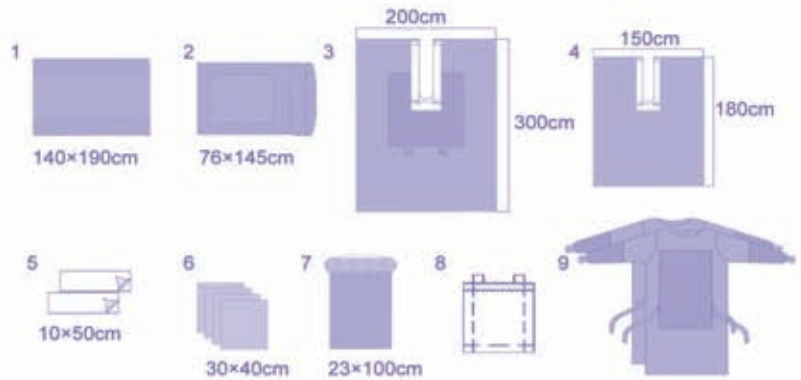

Impervious U Drape

U形手术单

REF	Size(cm)	Description
21701	150x180	Split 10x53cm, with 5cm Adhesive



Ortho-U Drape

U形手术单

REF	Size(cm)	Description
21702	200x300cm	Split 10x100cm, with 5cm Adhesive, Reinforcement 75x120cm, 2 tube holders



Vertical Isolation Drape

垂直隔离单

REF	Size(cm)	Description
21801	230x320	Incise film 30x80cm, Fluid collection pouch 90x60cm with filter and valve, 2 Instrument pouch 25x28cm, Tape on top 3cm width, 2 Velcro Tube holder



妇产科、泌尿科手术

GYNAECOLOGY, OBSTETRICS & UROLOGY



T.U.R Drape

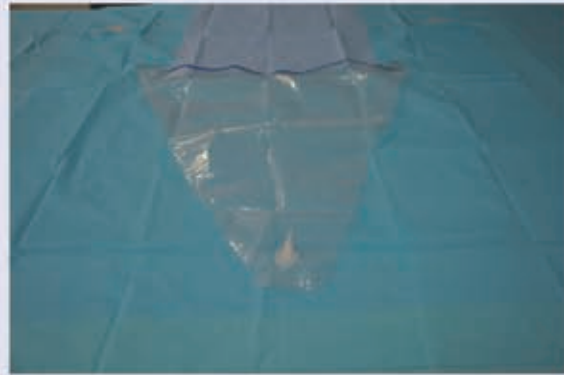

Under buttock Drape

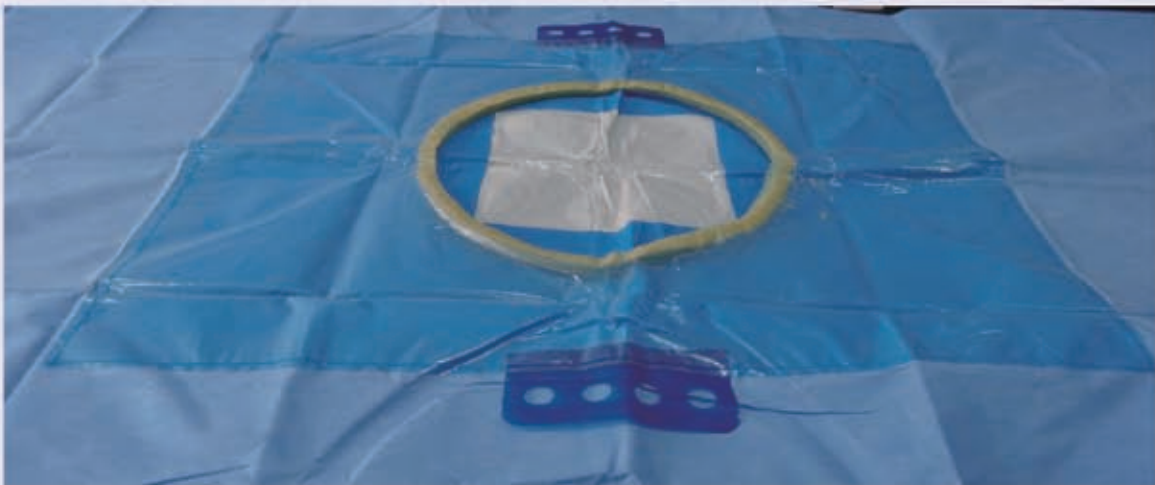

C-Section Drape



Delivery Pack

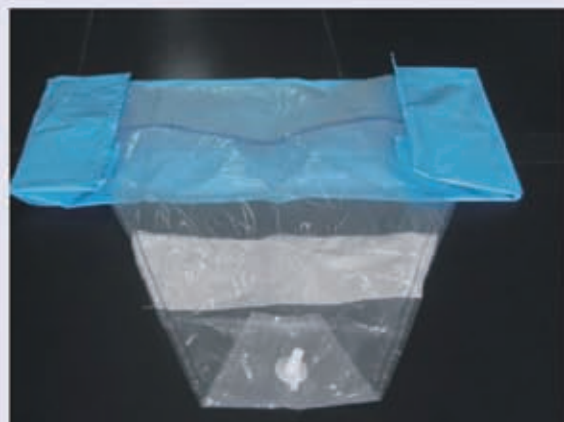

Under buttock Drape



Disposable Sterile C-Section Surgical (AK:30101)

Quantity	Product Description
1	Back Table Cover 140x190cm
1	Mayo Stand Cover 76x145cm
1	C-section Drape,fluid collection pouch with 2 suction port 72x80cm and forming wire,full incision film 40x40cm,tube holders,Armboard covers, 240x300x195cm
4	Hand Towel 30x40cm
3	Reinforced Surgical Gown with 2pcs hand towel, XL
2	Baby Blanket 60x90cm



Disposable Sterile Caesarean Pack(AK:30102)

Quantity	Product Description
1	Back Table Cover 140x200cm
1	Mayo Stand Cover 58x137cm
1	C-section Drape 195x300x240cm,fluid collection pouch with 2 suction port 72x75cm and forming wire,full incision film 34x34cm with Teardrop fenestration 24x20cm,4 tube holders,armboard covers
6	Hand Towel 30x40cm
3	Reinforced Surgical Gown with 2pcs hand towel, XXL
1	Baby Blanket 60x90cm
20	Gauze Swab,16Ply,with X ray 10x10cm
10	Abdominal Mops-X rayed,4ply,with string, 45x45cm
1	Cord Clamp
1	Placenta basin,with white lead, 31.5x24.5x7cm
1	Suture Bag
1	Suction Tube and Nozzle
1	Omphacut
1	Under Pad 90x120cm
1	SMS Wrap, 100x100cm



Baby Birth Delivery Kit (AK:30202)

Quantity	Product Description
1	Back Table Cover 150x100cm
2	Exam Glove
2	ID Bracelets
1	Ear Bulb Syringe 2oz
1	OB Maternity pad
1	Facemask with earloop
1	Disposable Bag 30x45cm
2	Standard Surgical Gown L
1	Underwear
5	Gauze Sawb ,8Ply, 10x10cm
1	Baby Blanket 60x90cm
1	Stabling Tracks 60x90cm
1	Shirt for Woman in Birth
2	Umbilical cord clamp, 5cm



OB Pack(AK:30203)

Quantity	Product Description
1	Back Table Cover 112x190cm
1	Under Buttocks Drape,with fluid collection pouch,absorbent zone 76x110cm
1	Hand towel 30x40cm
1	Abdominal Drape Reinforced 100x150cm
2	Leggings ,15cm Cuff 75x120cm
1	Standard Surgical Gown,AR6-8, L
1	Baby Blanket 60x90cm
2	Maternity Pads 10x32cm
1	Cord Clamp
5	Bulb Syringe
0	Guaze,8 Ply,with X ray,10x10cm
1	Small Tray
2	Placenta Basin 24.5x13.5x5cm
1	Vaginal Cotton Stick



Maternal and Newborn care kits (AK:30205)

Quantity	Product Description
1	Back Table Cover 140x120cm
1	Absorbent Pad 60x90cm
1	Towel, mother, to prevent perineal tears 100x70cm
1	Umbilical Cord Clamp, without scissor
1	Cap for Newborn, Cotton
2	Packet for Waste
2	Standard Surgical Gown L
2	Face mask
1	Bed Sheet 140x200cm
2	Surgical Cap
4	Shoe Covers
1	Absorbent Sheet 60x60cm
3	Surgical Gloves, Sterile #6.5#7#7.5
2	Towel, newborn Baby 60x60cm
1	Pediatric Suction Set
1	Syringe, single use 3ml

C-Section Drapes

剖腹产手术单

REF	Size(cm)	Description
31101	250x310x190	Full Incise film 34x34cm, Fluid collection pouch with 2 suction port 75x75cm and forming wire, Absorbent zone 30x50cm

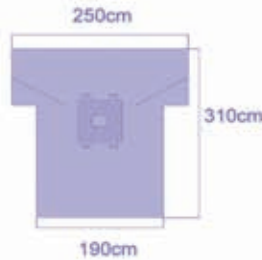

C-Section Drape

剖腹产手术单

REF	Size(cm)	Description
31102	250x310x190	Full Incise film 34x34cm with Teardrop fenestration 25x20cm, Fluid collection pouch with 2 suction port 75x90cm and forming wire, Tube holders, Armboard Cover

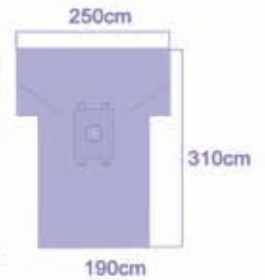

Under Buttock Drape

臀底单

REF	Size(cm)	Description
31201	90x120	PE Film fabric reinforcement

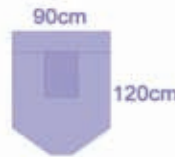

Under Buttock Drape

臀底单

REF	Size(cm)	Description
31202	86x110cm	With Fluid Collection Pouch, sreen and suction port, forming wire, Absorbent zone 30x45cm



Under Buttock Drape

臀底单

REF	Size(cm)	Description
31203	102x112	Graduate Fluid Collection Pouch, sreen and suction port, forming wire, Absorbent zone 30x45cm

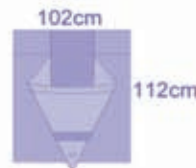

Lithotomy Pack(AK:30301)

切石术手术包

No.	REF	Description	QTY
1	8201	Back Table Cover 140x190cm	1
2	31301	Lithotomy T Drape 150x220x75cm	1
3		Utility Drape with Adhesive 38x66cm	1
6	90201	Hand Towel 30x40cm	2
7	90101	Leggings 75x120cm	2

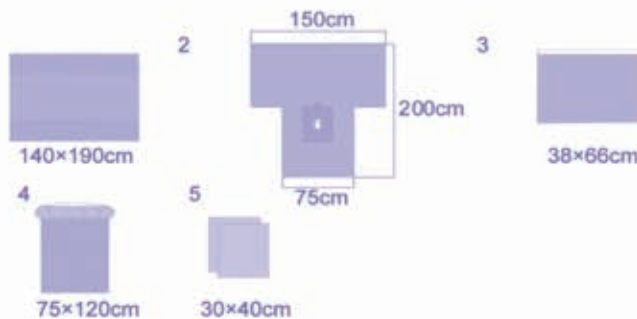

Lithotomy T Drape 切石术手术单

REF	Size(cm)	Description
31301	150x200x75	Rectangular Adhesive Fenestration 10x15cm, Absorbent Reinforcement 90x40cm

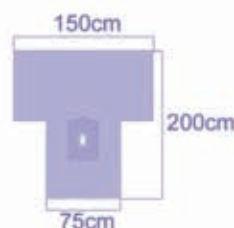

T.U.R Pack(AK:30401)

泌尿科手术包

No.	REF	Description	QTY
1	8201	Back Table Cover 140x190cm	1
2	31401	T.U.R Drape 175x238x170cm	1
3		Sterilization Wrap 100x100cm	1
4	90201	Hand Towel 30x40cm	1

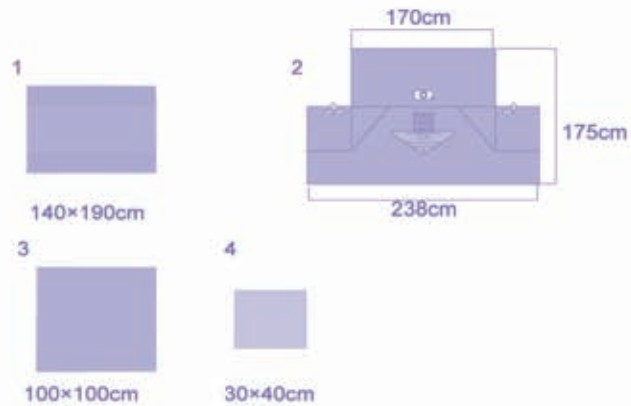

T.U.R Drape

泌尿科手术单

REF	Size(cm)	Description
31401	175x238x170	Triangular Fluid collection pouch, with screen, valve, with finger cot, Fenestration Dia.7cm, with taoe zone of 12x18cm, Tube holders



Cystoscopy Pack(AK:30501)

膀胱镜手术包

No.	REF	Description	QTY
1	8201	Back Table Cover 140x190cm	1
2	31501	Cystoscopy T Drape, 80x150x210cm	1
3	90505	Leggings 75x120cm	2
6	90201	Hand Towel 30x40cm	1

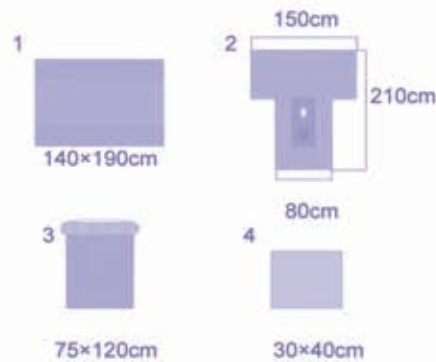

Cystoscopy T Drape

膀胱镜手术单

REF	Size(cm)	Description
31501	80x150x210	Perineal Fenestration 8x15cm,22x22cm mesh screen, with tape, fabric reinforcement 75x120cm,2 Tube holders



眼科、耳鼻喉类手术

OPHTHALMOLOGY&ENT



Ophthalmic Pack

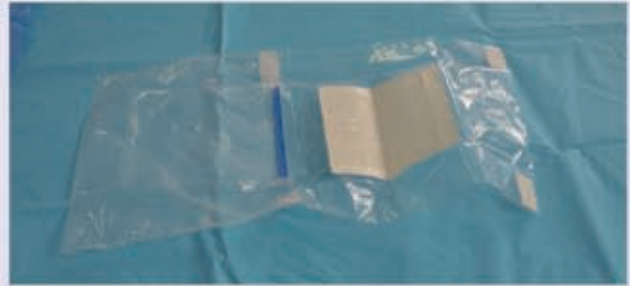

Eye Drape

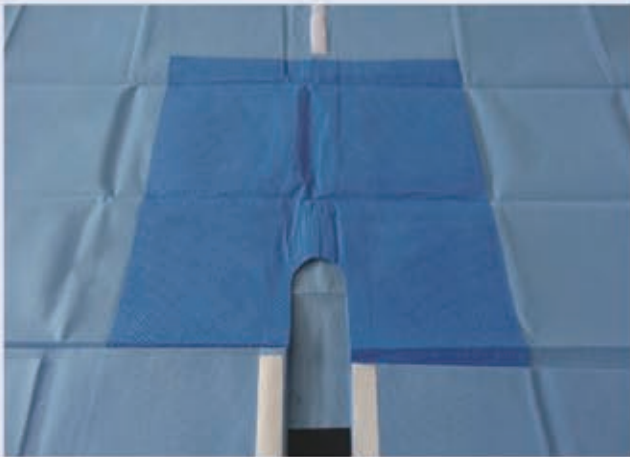

ENT Split Drape

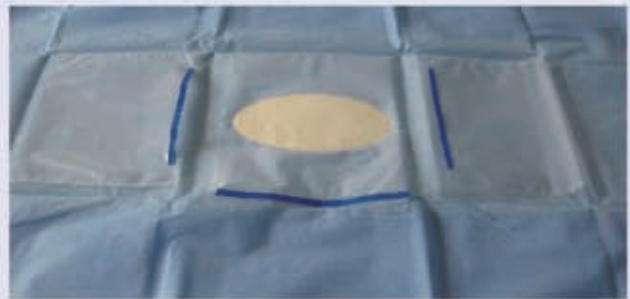

Eye Drape



Eye Drape

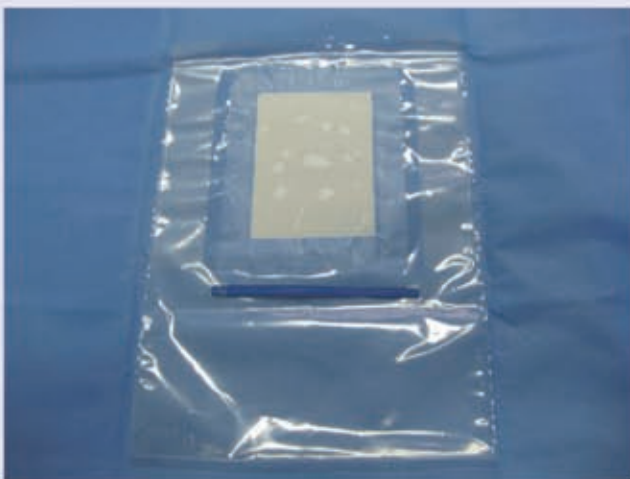

Eye Drape



Eye Drape



Eye Drape Kit(AK:40101)

Quantity	Product Description
1	Equipment Table Cover 150x190cm
1	Mayo Stand Cover 58x137cm
1	Armboard Cover with Tape 75x35cm
1	Surgical Tray
1	Surgical Gown,45gsm SMS
2	Nowoven Gauze 10x10cm
2	Gallipot 60ml
2	Orange Needle Hypodermic
1	Syringe Luer-Lock
2	Eye Spears
4	Eye Pad 6x8cm
1	Surgical Gloves
3	Eye Drape 90x100cm,SMS 45gsm
2	Hand Towel 30x40cm



Refractive Eye Kit (AK:40104)

Quantity	Product Description
1	Equipment Table Cover 140x100cm
3	Surgical Gown,45gsm SMS
3	Doctor Cap
10	Eye Sponge
3	Facemask with tie-on
10	Absorbent Stick
2	Eye Pad 6x8cm
1	Nonwoven Gauze Swab 10x10cm
1	Dual Eye Drape 150x100cm,SMS 45gsm
2	Hand Towel 30x40cm



Ophthalmic Intravitrea Pack (AK:40106)

Quantity	Product Description
1	Equipment Table Cover 75x100cm
1	Eyelid Retractor
1	Scissor
1	Ruler
3	Cotton Buds
1	Plastic Bowl 250ml
1	Plastic Tray 24x28x5cm
10	Nonwoven Gauze Swab 10x10cm
1	Eye Drape 75x100cm,SMS 45gsm
1	Syringe 1ml



Ophthalmology Surgery Drape Pack (AK:40107)

Quantity	Product Description
1	Equipment Table Cover 150x140cm
1	Ramsey Dressing Forceps 14cm
10	Cotton Buds
2	Surgical Gown,45gsm SMS,L
10	Gauze Sponge 10x10cm
1	Eye Shield,Clear,Universal
1	Syringe without needle Luer slip 10ml
2	Syringe without needle Luer slip 3ml
1	Syringe without needle Luer slip 5ml
3	Syringe without needle Luer slip 1ml
2	Eye Pad 6x8cm
1	Eye Drape 140x120cm,SMS 45gsm
4	Hand Towel 30x40cm
2	Medicine Cup 3OZ
1	Kidney Dish 700ml
1	Hypodermic Needle 25G
3	Hypodermic Needle 23G
1	Hypodermic Needle 18G
1	Hypodermic Needle 27G

Eye Drape 眼科手术单

REF	Size(cm)	Description
41101	50x50	Round fenestration with collection pouch
41102	100x120	Incise film 11x12cm, collection pouch 25x30cm, fenestration size:9x9cm
41103	120x140	with one single fluid collection pouch, 9x9cm fenestration with incise film
41104	150x200	with double fluid collection pouch, 5x8cm oval fenestration with incise fleywire
41105	140x140	without fluid collection pouch, with oval fenestration 6x9cm, incise film cut 7cm
41106	25x45	PE film with incise film, and fluid collection pouch

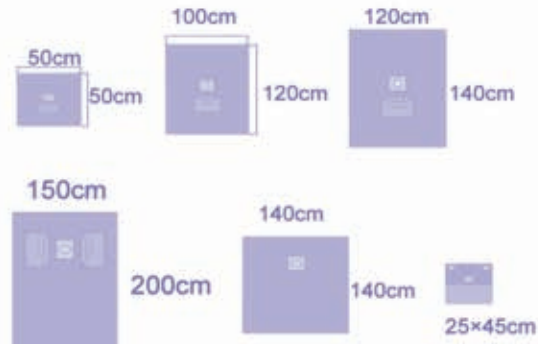

ENT PACK(AK:40201) 耳鼻喉手术包

No.	REF	Description	QTY
1	8205	Back Table Cover 150x140cm	1
2	8101	Mayo Stand Cover 58x137cm	1
3		Head turban drape 75x120cm	2
4	41201	ENT split drape 190x300cm	1

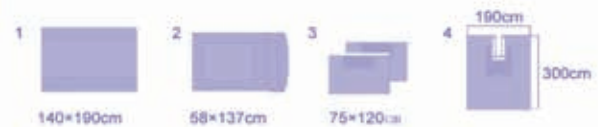

ENT SPLIT DRAPES 耳鼻喉手术单

REF	Size(cm)	Description
41201	190x300	with 8x70cm split, with adhesive, fabric reinforcement 75x120cm, 2 tube holder



神经类手术

NEUROLOGY



Cranitomy Drape



Cranitomy Drape

NEUROLOGY 神经类手术

Neuro Pack(AK:50101) 开颅手术包

No.	Ref	Name	Qty
1	8201	Back Table Cover 190x140cm	1
2	8102	Mayo Stand Cover 76x145cm	1
3	51101	Craniotomy drape 250x260cm with incise film and pouch , oval fenestration	1
4	90201	Absorbent Towel 30x40cm	2
5		Utility Drapes with adhesive tape 75x50cm	2

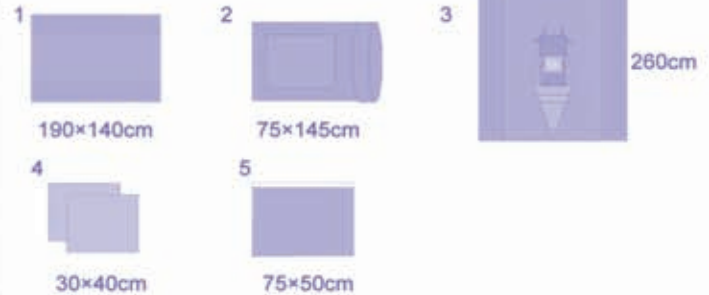

Craniotomy Drape 开颅手术单

REF	Size(cm)	Description
51101	250x260	50cm PE panel on both sides, Absorbent reinforced 50x160cm, Fluid Collection Pouch 50x76cm, Forming Wire, Mesh Strainer, Drainage Port, Oval Incise Film 26x20cm, Velcro holding tube



Craniotomy T Drape 开颅手术单

REF	Size(cm)	Description
51102	310x200x340	Absorbent Reinforced 90x60cm, Fluid Collection Pouch 60x90cm, Forming Wire, Mesh Strainer. Drainage Port, Oval incise film 26x20cm, Velcro Holding Tabs, Gusseted Anesthesia Panels

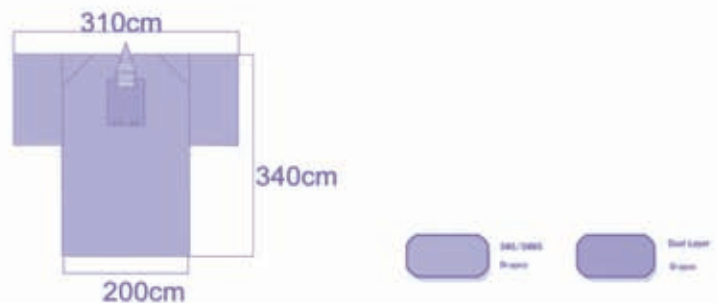

心脏心血管类手术

CARDIOVASCULAR & ANGIOGRAPHY



Angiography

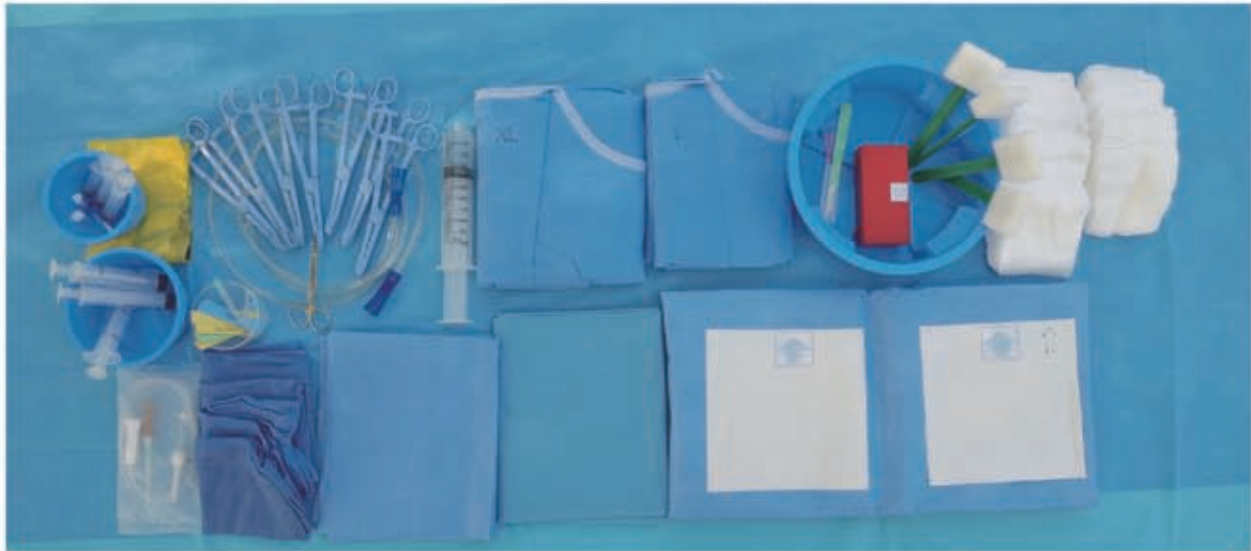

Dispsosable Sterile Angiography Set(AK:60102)

- 1 x Trolley Cover 300x160cm
- 1 x Femoral Angiography Drape 210x290cm,femoral Fen. Ø12cm,incision film
- 1 x Angiography Syringe 100ml
- 1 xHigh Rressure Stopcock
- 4x Scissors
- 50xGauze 10x10cm
- 1 x Pressure Line
- 4x Sponge Prep with Handles
- 1x Introducer Needle
- 1x Scalpel
- 4 x Towel Cotton
- 7 x Towel Clamp
- 1 x Guide Wire Bowl
- 1 x Label Set
- 2 x SurgicalGown L&XL
- 4 x Bowl
- 1 x Needle Container
- 2x Banded Bag 75x90cm
- 2xNeedle 21Gx1.5"& 22Gx1.5"
- 6 x Syringes
- 1 x Drape 90x150cm
- 16x Printed labels
- 1 x Administration set
- 1 x Waste bag



Disposable Sterile Angiographics (AK:60103)

- 1 x Trolley Cover 140x150cm
- 1 x Femoral Angiography Drape 240x300cm, femoral Fen. Ø12cm, incision film
- 1 x Equipment Protector Cover 80x110cm
- 1 x Image Intensifier Cover, 140cm
- 20x Gauze, 8ply 10x10cm
- 1x Sponge
- 1 x Scalpel #11
- 2x Surgical gown XL
- 1x Plastic Bowl 500ml
- 1x Plastic Cup 60ml
- 1 x Tray 30x30x5cm



Disposable Sterile Cath-Lab Kit(AK:60104)

- 1pc Back Table cover 140x150cm
- 1pc Femoral Angiography Drape, femoral fenestration
Φ 12cm, incision film, 240x300cm
- 1pc Equipment Protector Cover, 80x110cm
- 1pc Image Cover Dia. 90cm
- 2pcs Adhesive Drape, 2ply, 50x60cm
- 1pc Finger Grip Syringe, 10ml
- 1pc Guidewire, 0.035x150cm
- 1pc Infuset Vented
- 1pc Introducer Needle, 18Gx7cm
- 1pc Angio Manifold Set, 500ml



Disposable Sterile Radiofrequency Pack (A K:60105)

- 1 x Trolley Cover 220x140cm
- 1 x U-Split Drape 310x220cm
- 1 x Plastic Bag for Rubbish, 75x55cm
- 5 x Plain Gauze 10x10cm
- 2 x Swab Sticks
- 1 x Scalpel
- 4 x Towel Cotton 55x40cm
- 3 x Plastic Towel Clamps
- 1 x Surgical Gown, L
- 2 x Plastic Bowls 250ml
- 2 x Plastic Kidney Dish 700ml
- 2 x Syringe 5ml
- 1 x syringe 10ml
- 1 x 3-way tap
- 1 x Ultrasound Gel 250ml
- 1 x Ultrasonic Procedure Kit (1xUltrasound probe protector, 2xRubber Bands)
- 1 x 1pc 7 French Sheath Kit (including J-wire, scalpel, introducer needle), 11cm
- 1 x Plastic Isolation Bag, 50x50cm
- 1 x Needle 31Gx1.5cm
- 1 x Needle 23Gx4cm
- 1 x Needle 21Gx 7cm
- 1 x Spinal Needle, 21Gx9cm
- 2 x Sticky Labels



Radiology Kit (AK:60107)

- 1 x Scissor Mayo St.5 1/2"
- 1XFCP Kelly Str. 5 1/2"
- 2xSyringe L/S,5cc;
- Syringe L/L 10cc
- 3x Needle REg.Bev.18G,27G,23G
- 2x Bowl,Solution 8oz
- 1xBasin,Emesis 700cc
- 1xTray 9x10x2; 1xTray 9x5x2
- 2xStandard Surgical Gown,XL
- 1xTable Cover 44" x44"
- 1xHalf Drape 44" x55"
- 1xMinor Procedure Drape with 3" Fen,48" x60"
- 4xSlide,Glass Frosted 1" x3"
- 1xScapel,Lance#11
- 20xGauze Sponge,12ply,4" x4"
- 1xGauze Sponge,16ply,4" x4"

Angiography Drape Pack(AK:60101)

心血管手术包

No.	Ref	Name	Qty
1	8201	Back Table Cover 190x140cm	1
2		Sterilization wrap 90x90cm	1
3	61102	Femoral Angiography drape 220x320cm	1
4	90201	Hand Towel 30x40cm	4
5	11002	Medium drape 75x90cm	1
6		Light cover round, Dia 80cm	1
7		Light cover square, 100x150cm	1
8	GS012	Reinforced surgical gown, XL	2

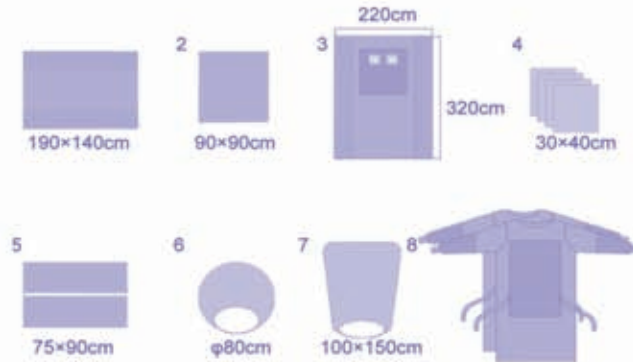

Angiography Drape

心血管手术单

REF	Size(cm)	Description
61101	220x320	Dual Clear Panels 50cm width, Absorbent Reinforcement 75x100cm, two Fenestration dia 14cm, Two incise film with fenestration dia 7.5cm



Radial Femoral Angiography Drape

心血管手术单

REF	Size(cm)	Description
61102	220x320	Dual Clear Panels 50cm width, Absorbent Reinforcement 100x75cm, Femoral fenestration Dia 12cm, Incise film with fenestration Dia 8cm, Radial fenestration oval 12cm x8cm, with fenestration Dia 6x4cm



Femoral Angiography Drape with Pouch 心血管手术单

REF	Size(cm)	Description
61103	240x370	Dual Clear Side Panels 50cm Width,Absorbent Reinforcement 125x130cm,2 collection pouch 125x15cm,Femoral fenestration Dia 12cm,incise film with fenestration Dia 6cm, Radial fenestration 12 cm ,with fenestration Dia 9cm

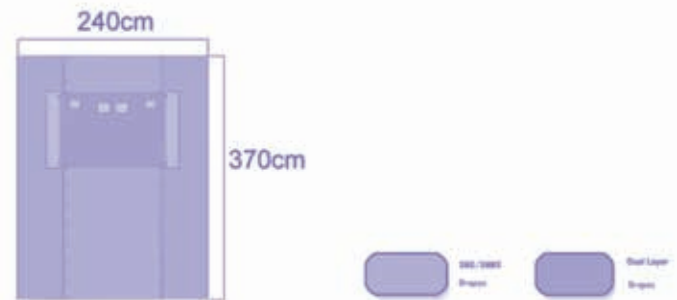

Brachial Angiography Drape 心血管手术单

REF	Size(cm)	Description
61104	80x110	Absorbent Reinforcement 30x60cm,Round central fenestration of 7cm with incise film



Cardiovascular Pack 心脏手术包

No.	REF	Name	Qty
1	8102	Backtable Cover 190x140cm	1
2	90505	Sterilization wrap 100x100cm	1
3	61201	Cardiovascular drape 200x300x350cm	1
4	90201	Hand Towel 30x40cm	4
5		Perinea Drape190x240cm	1
6		Foot Cover	2
7		Utility Drapes with adhesive tape 75x75cm	2
8	90301	OP Tape 10x50cm	1
9		Suture Bag	1
10	GS012	Standard surgical gown,XL	2
11	8102	Mayo Stand Cover 76x145cm	1

Cardiovascular Drape 心脏手术单

REF	Size(cm)	Description
61201	200x300x350	Adhesive split 20x200cm,2 fluid collection pouch 40x100cm,Dual split zone reinforced 25x190cm, Velcro Holding Tabs, Armboardcover

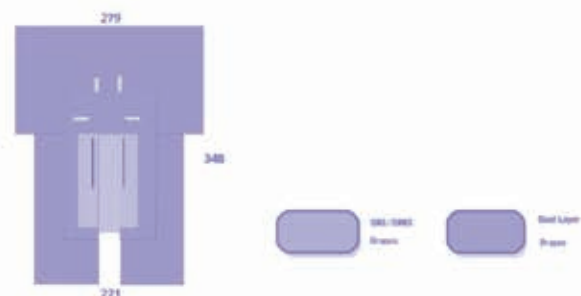

牙科手术包

DENTAL PACK



DENTAL PACK (AK:70111)

- 1x Surgical Drape 70x75cm with adhesive tape, 2Layers
- 1x U Drape 133x100cm, with adhesive hole 6.5x50cm, 2Layers
- 2x Adhesive Surgical Drape 75x90cm, 2Layers
- 1 x Back Table Cover 150x160cm
- 2x SMS Standard Surgical Gown, L
- 1x Mayo Table Cover 80x145cm
- 1x Gauze Swab, Dia. 3cm
- 2x Surgical Cap
- 1x Patient Disinfection Kit (1 Bowl + Medical Swab)
- 1x Bouffant Cap
- 1x Aspiration Tubes 2m with Yankuer Tips
- 1x Waste Bag 22x53cm, Self sealing
- 1x Transparent PE Drape 40x50cm with adhesive
- 1x Tubing Sleeve 8x240cm, with carton inserter 7.5x19.5cm



Implant Kit (AK:70107)

- 1 x Aspiration set with cannula, tubing 2.7 m
- 1 x Bone filter with cannula
- 1 x Universal irrigation set 1 or 2 ways
- 4 x Polyethylene gloves
- 1 x Surgeon cap with tie
- 1x Hood
- 3 x Surgical face mask with ties
- 2 x Nurse cap with elastic
- 6 x Shoe cover
- 1 x Isolation gown
- 1 x Bag for X-ray tube
- 1 x Dental chair cover 190x105 cm
- 1 x Drape 1500x1500 mm with adhesive
- 1 x absorbing drape 150x150 cm with adhesive and velcro fixation for tubing
- 2 x Drape 100x100cm with adhesive
- 1 x Drape fenestrated 80x70 cm
- 1 x Drape fenestrated with adhesive in the center 800x700 mm
- 4 x Tubing protection 120x8 cm
- 2 x Scalytic lamp handle cover
- 1 x Plastic bag 80x50cm
- 1 x Support for tubing with adhesive
- 2 x Barrier film blue (30x10 cm)
- 2 x Sterile surgical gown
- 2 x Hand towels
- 2 x Adhesive band 50x5 cm
- 2 x Nail Brush
- 1 x External irrigation set
- 1x Saliva ejector
- 2 x Latex free elastic
- 1x Medical Pouch 42x53cm
- 1xCrepe Wrap 100x100cm
- 1 x Calipper



Dental Surgical Set(AK:70113)

- 3x Surgical Drape 60x80cm with adhesive tape
- 1x Patient Drape 90x90cm
- 1x Surgical Drape 15x20cm with adhesive tape
- 1 x Back Table Cover 150x100cm
- 2x Spunlance Standard Surgical Gown,L
- 3 x Hand Towel 30x40cm
- 2x Surgical Cap
- 2x Face Mask with Eye-shield
- 1x Patient Cap
- 2x Aspiration Tubes&Yankuer Tips
- 1x Scalpel Blade #15
- 1x Scalpel Blade #12
- 5x Gauze 5x5cm
- 1x Gallipot 50ml
- 2x Tube Covers with adhesive tape 8x120cm
- 1x Paper Ruler 10cm
- 1x Overall Pack Wrap 80x80cm
- 1x Light Handle Covers,15x20cm with reinforced elastic mouth

设备仪器罩

EQUIPMENT COVER



Mayo stand Cover



Mayo stand Cover



Back Table Cover



Banded Bag

Mayo Stand Cover 梅奥单

REF	Size(cm)	Description
8101	58x137	Reinforced 48x60cm W/15cm draping cuff
8102	76x145	Reinforced 60x75m,W/15cm Draping Cuff

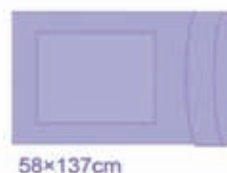

58×137cm

Back Table Cover 桌布

REF	Size(cm)	Description
8201	140x190	with 80cm zone-reinforced
8202	150x220	with 80cm zone-reinforced
8203	110x200	with 60cm zone-reinforced
8204	150x200	full reinforced



140×190cm

Banded Bag 仪器罩

REF	Size(cm)	Description
8301	60x60	D-22cm, Latex free elastic at the opening
8302	100x75	D-25cm, Latex free elastic at the opening
8303	115x135	D-40cm, Latex free elastic at the opening



60×60cm



100×75cm

配件、附件

ACCESSORIES

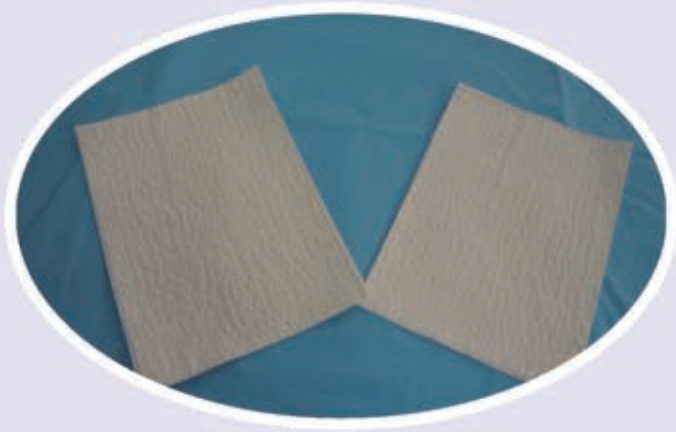

Hand Towel



Stockinette



Bed Cover



Baby Blanket

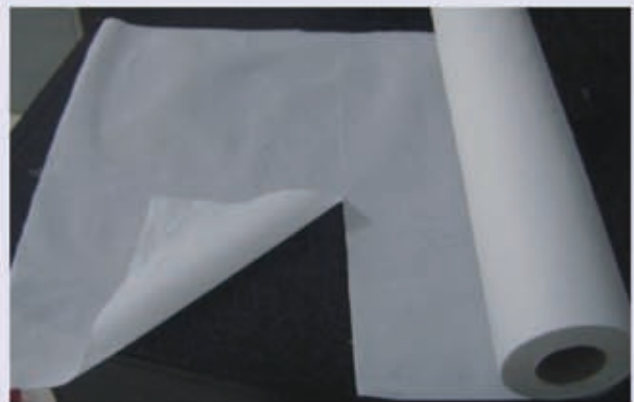

Bedsheet Roll

Leggings 腿套

REF	Size(cm)	Description
90101	75x120	with 15cm cuff



75x120cm



Impervious Stockinette 弹性腿套

REF	Size(cm)	Description
90102	Small	15x76cm,stretchable,telescope folding
90103	Medium	23x100cm,stretchable,telescope folding
90104	Large	30x120cm,stretchable,telescope folding



30x120cm

Absorbent Hand Towel 擦手巾

REF	Size(cm)	Description
90201	30x40	scrimed reinforced,4ply,68gsm
90202	38x56	
90203	32x32	Airlaid tissue,55gsm
90204	40x40	
90205	15x50	spunlace nonwoven,80gsm
90206	45x60	100%cotton,OR Towel
90207	40x40	



30x40cm

Tape Strip 胶条

REF	Size(cm)	Description
90301	10x50	SMS lamination



Antimicrobial Incise Drape 手术膜

REF	Size(cm)	Description
90401	10x10	PU or PE material
90402	10x20	PU or PE material
90403	20x30	PU or PE material
90404	35x60	PU or PE material
90405	60x90	PU or PE material



Antimicrobial Incise Film with Idophor
 含碘手术膜

REF	Size(cm)	Description
90406	10x10	PU or PE material
90407	20x30	PU or PE material
90408	35x60	PU or PE material
90409	85x90	PU or PE material



ACCESSORIES 配件、附件

Regular Sterilization Wrap

常规克重包布

REF	Size(cm)	Description
90501	45x45	SMMS or SMS or crepe paper material
90502	60x60	
90503	75x75	
90504	90x90	
90505	100x100	
90506	120x120	
90507	135x135	



75×75cm

Medium Weight Wrap

中克重包布

REF	Size(cm)	Description
90508	45x45	SMMS or SMS or crepe paper material
90509	60x60	
90510	90x90	
90511	100x100	
90512	120x120	
90513	135x135	
90514	135x180	



135×180cm

Heavy Duty Wrap

高克重包布

REF	Size(cm)	Description
90515	60x60	SMMS or SMS material
90516	90x90	
90517	120x120	
90518	135x135	
90519	135x180	
90520	135x225	



135×225cm

Nonwoven Disposable Bedsheet

We provide 6 types of bedsheet for your choice

A style:Fitted Mattress Protector,Elastic all around 1/2

B style:with elastic at 4 corners

C Style:Flat bedsheet with 4 elastic at each corner

D style:No elastic

E style:With 2 elastic on 2 sides

F style:With full elastic all around 4 sides

REF	Size(cm)	Description
90601	110x220	For bed 90x190cm
90602	170x220	For bed 140x190cm
90603	190x230	For bed 160x200cm



A



ED



F

Nonwoven Disposable Bedsheet

Roll 一次性无纺布卷

REF	Size	Description
90901	50cmx50M	With perforation or without,Material available:PP/SMS/PP+PE/Tissue+PE
90902	60cmx50M	
90903	60cmx5200M	
90904	70cmx50M	
90905	70cmx100M	
90906	70cmx200M	
90907	90cmx200M	



Fluid Collection Pouch 积液袋

REF	Size	Description
91001	115x58	Arthroscopy pouch,adhesive strip,exit port,flexwire
91002	85x80	U pouch,split 55x14cm,2exit port,with tape
91003	27x21	With flexwire,adhesive
91004	74x87	With incise film,tube holder,2 exit port



115x58cm



85x80cm



27x21cm



74x87cm

Baby Blanket 婴儿毯

REF	Size	Description
91101	60x90	Spunlance nonwoven



Velcro 魔术贴

REF	Size	Description
91201	2.5x12	with adhesive at backside



Knitted Cuff 螺纹袖口

REF	Size	Description
91301	5x10	Weight:3g,cotton



防护类产品

PROTECTIVE PRODUCTS



Cap



Mask



Coverall

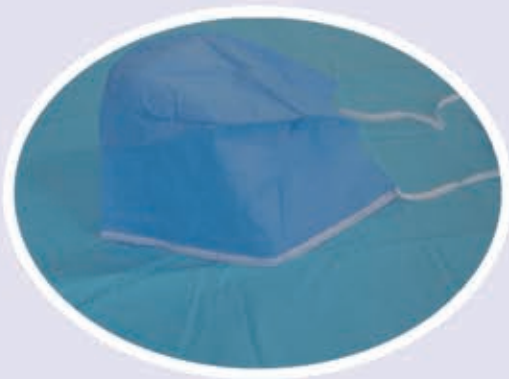

Cap



Shoe Cover



Scrub Suit



Scrub Suit

Headwear 帽子

REF	Description
0101	Bouffant,21",PP nonwoven
0102	Surgical cap with tie on
0103	Surgical cap with elastic
0104	Surgical hood with tie



Facemask 口罩

REF	Description
0201	with earloop,3ply
0202	with tie-on,3ply
0203	with shield,3ply

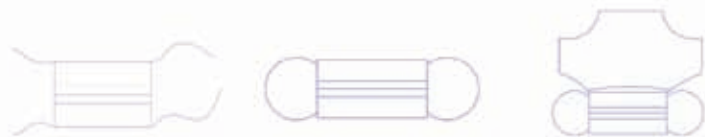

Shoecover 鞋套

REF	Description
0301	Material:PP/SMS/PE/CPE



Shorts 短裤

REF	Size(cm)	Description
0401	M(71x58)	50gsm PP,with 3 velcro
0402	L (87x65cm)	50gsm PP,with 3 velcro



Scub Suit 洗手衣

REF	Size(cm)	Description
0501	M,L,XL,XXL	V-neck,SMS material,2pocket



Isolation Gown 隔离服

REF	Size(cm)	Description
0601	M,L,XL,XXL	With elastic or with cuff,PP material



Coverall 防护服

REF	Size(cm)	Description
0701	S,M,L,XL,XXL	All sewing parts are heat-sealed with tape,breathable,waterproof,high level or hydrostatic



Coverall

防护服

1. Size: S M L XL 2XL 3XL 4XL 5XL 6XL 7XL
2. Material: PP, PP+PE, SMS, PE
3. With hood no boot & with hood with boot, front zipper
4. With elastic waist, cuff and ankle
4. Different color, different weight available
5. Package: 1PCS/BAG 50PCS/CTN



Disposable Isolation Gown

一次性隔离衣

1. Size: 115×137cm, 110×130cm, 120×140cm
2. Material: PP, PP+PE, SMS, PE
3. With knitted cuffs & elastic cuffs
4. Different: color, different weight available
5. Package: 10PCS/BAG 100PCS/CTN



Scrub Suits

洗手衣

1. Material: PPSB, SMS, PP+PE
2. Different size, different weight, different color available
5. Package: 1SUIT/BAG 50SUITS/CTN



Lab Coat

实验服

1. Size: 110×130cm, 120×140cm 135×150cm,
2. Material: PP SMS SF
3. Different color, different weight available
5. Package: 10PCS/BAG 100PCS/CTN



PROTECTIVE PRODUCTS 防护类产品

Disposable Non-Woven Face Mask

一次性无纺布口罩

1. Ear-Loop
2. Blue, Green, White, Red, Yellow, Pink
3. 1-PLY 2-PLY 3-PLY 4-PLY
4. Package: 50 PCS/BOX 2000PCS/CTN



Disposable Activated Carbon Dust Mask

活性炭防尘口罩

1. Cone Shape
2. Different material
3. Package: 50PCS/BAG 400PCS/CTN



N95 Respirator Dust Mask

N95呼吸阀口罩

1. Material: PP
- White, Grey
3. With Valve or Not
4. Packaging: 20pcs/box, 50boxes/ctn



Children Face Mask(Printed)

印花口罩

Package: 1PCS/BAG 50PCS/BOX 1000PCS/CTN



Disposable Surgical Face Mask

一次性无纺布手术口罩

1. Tie-on
2. Blue, Green, White, Red, Yellow, Pink
3. 1-PLY 2-PLY 3-PLY 4-PLY
4. Package: 100PCS/BOX 2000PCS/CTN

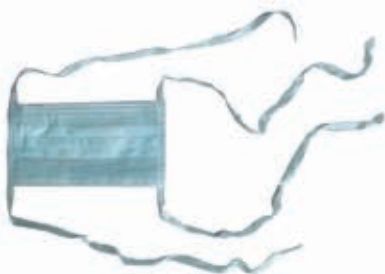

Paper Face Mask

纸口罩

1. 1-PLY 2-PLY
2. Package: 100PCS/BOX 1000PCS/CTN



Doctor Cap

医生帽

1. Size: 20", 21", 24"
2. Color: Blue, Green, White, Yellow
3. Package: 100PCS/BAG 2000PCS/CTN



Doctor Cap (with elastic)

橡筋医生帽

1. Size: 20", 21", 24"
2. Color: Blue, Green, White, Yellow
3. Package: 100PCS/BAG 2000PCS/CTN



Mob Cap

条形帽

1. Size: 18", 21", 24", 28"
2. Weight: 10g, 12g, 14g, etc.
3. Color: Different color available
4. Package: 100PCS/BAG 2000PCS/CTN



Bouffant Cap

圆帽

1. Size: 18", 21", 24", 28"
2. Weight: 10g, 12g, 14g, etc.
3. Color: Different color available
4. Package: 100PCS/BAG 2000PCS/CTN



Non-woven headband (printed)

印花束发带

1. Size: 20", 19", 21", etc.
2. Color: Different color
3. Package: 100PCS/BAG 2000PCS/CTN



Mesh Cap

网眼帽

1. Size: 20", 19", 21", etc.
2. Color: Different color
3. Package: 100PCS/BAG 2000PCS/CTN



PROTECTIVE PRODUCTS 防护类产品

Shots

短裤

1. Size: Free size as requested
2. Weight: 30g, 40g, etc.
3. Color: Different color
4. Material: PP, SMS, SPUNLACE
5. Package: 10PCS/BAG 1000PCS/CTN



T-shaped Pants

丁字裤

1. Size: Free size as requested
2. Weight: 30g, 40g, etc.
3. Color: Different color
4. Material: PP, SMS, SPUNLACE
5. Package: 1PCS/BAG 50PCS/MIDDLE BAG 1000PCS/CTN



Disposable Underwear

一次性内衣

1. Size: Free size
2. Weight: 25g, 30g, etc.
3. Color: Different color
4. Material: PP, SMS, SPUNLACE
5. Package: 1PCS/BAG 50PCS/MIDDLE BAG 1000PCS/CTN



Disposable Bathrobe

理发衣

1. Size: Free size as requested
2. Weight: 30g, 40g, etc.
3. Color: Different color
4. Material: PP, SMS, SPUNLACE
5. Package: 10PCS/BAG 200PCS/CTN



Disposable Bed Sheet, Pillow Cover, Bed Cover

一次性床单, 枕单, 床罩

Different Material, Different Size, Different color Available

1. Size: Free size as requested
2. Weight: 30g, 40g, etc.

3. Color: Different color
4. Material: PP, PP+PE, SMS, SPUNLACE
5. Package: 10PCS/BAG 200PCS/CTN



Shoe Cover(CPE)

CPE鞋套

1. Size: 36×15cm, 39×15cm, 40×15cm
2. Weight: 1.8g, 2.0g, 2.5, 3.0g, etc.
3. Color: Different color
4. Package: 100PCS/BAG 2000PCS/CTN



Non-woven Shoe Cover (regular)

无纺布普通鞋套

1. Size: 38×16cm, 40×16cm, 42×18cm etc.
2. Weight: 25g, 30g, 40g, etc.
3. Color: Different color
4. Package: 100PCS/BAG 2000PCS/CTN



Non-woven Shoe Cover(non-skid)

无纺布防滑鞋套

1. Size: 38×16cm, 40×16cm, 42×18cm etc.
2. Weight: 25g, 30g, 40g, etc.
3. Color: Different color
4. Material: PP, SMS
5. Package: 100PCS/BAG 2000PCS/CTN



Conductive Strip Shoe Cover

导电条鞋套

1. Size: 38×16cm, 40×16cm, 42×18cm etc.
2. Weight: 25g, 30g, 40g, etc.
3. Color: Different color
4. Material: PP, SMS
5. Package: 100PCS/BAG 2000PCS/CTN



PP+PE Boot Cover

PP+PE 靴套

1. Size: Free size as requested
2. Weight: 30g, 40g, etc.
3. Color: Different color
4. Material: PP, SMS, SF, PP+PE
5. Package: 10PCS/BAG 1000PCS/CTN



Disposable Slipper

一次性拖鞋

1. Size: 29×12cm, etc.
2. Weight: 30g, 40g, etc.
3. Color: Different color
4. Material: PP
5. Package: 1PAIR/BAG 50PAIR/BIG BAG, 1000PCS/CTN



Values >>

◆ Customer First

The interests of our customer must be our first priority.

◆ Teamwork

We believe teamwork enables ordinary people to achieve extraordinary things.

◆ Embrace Change

In this fast-changing world, we must be flexible, innovative and ready to adapt to new business conditions in order to survive.

◆ Integrity

We expect our people to uphold the highest standards of honesty and to deliver on their commitments.

◆ Passion

We expect our people to approach everything with fine in their belly and never give up on doing what they believe is right.

◆ Commitment

Employees who demonstrate perseverance and excellence are richly rewarded. Nothing should be taken lightly as we encourage our people to “work happy, and live seriously”.

