



DESK/FLOOR LAMP



Shenzhen RuiBeiTe Technology Co., Ltd





Company Profile

Shenzhen RuiBeiTe Technology Co. Ltd, one of the largest led desk lamp manufacturers and developers in Shenzhen, China, specializes in the production of led desk lamp for over 7 years, enjoying the high reputation in the lighting industries in China.

Our factory covers an area of 24,000 square meters, with 200-300 workers, 7-8 QC staff, 6-7 R&D engineers and three led desk lamp produce lines, having CE, ROHS, CCC Certification and ETL Certification audited by Intertek. Our main customers are “Ampco Co., Ltd”, “SCI”, “ENVIROBRITE”, “Panasonic”, and “Toshiba”, some famous brands all over the world.

After continuous efforts, RuiBeiTe products have been customers at home and abroad. Products exported to Europe and the United States, Japan, the Middle East and other markets. With a perfect production management system and strict quality control measures, will continue to contribute to the society of RuiBeiTe LED lighting products more high-quality, high energy saving, high life.

Timeline of RBT

- 1993 Established plastic molding factory.
- 1997 Expend the production for Color separation machine optical machine.
- 1999 Achieved ISO 9001 Certification.
- 2003 Cooperated with Panasonic for EMS project.
- 2004 Cooperated with Hitachi for PCB assemble.
- 2006 Cooperated with Toshiba for PCB assemble.
- 2007 Cooperated with Zojirushi and Fuji Film for PCB assemble.
- 2008 Beginning the mass production of LED Bulb, LED Tube and Driver for China market.
- 2009 Achieved ISO 9001.2008 Certification.
- 2010 Cooperated with DOSHISHA for PCB assemble.
- 2011 Beginning the mass production of LED Desk Lamp for China Market.
- 2012 Beginning the production of bicycle rear lamp for Panasonic and Beginning the International Trade of LED Lighting.
- 2015 Cooperated with Cado design Company for the new product development.
- 2016 Achieved ISO 9001.2015 Certification





OUR CERTIFICATION

RuibeiTe advocate energy conservation and environmental protection, green lighting, LED lighting market oriented, provide high energy, low light attenuation, long life of the application of LED lighting products and leading solutions for customers. The spirit of "science and technology first, quality first, service first" business philosophy, constantly introducing advanced automated production equipment, the science and technology into life, promote the healthy development of green lighting.

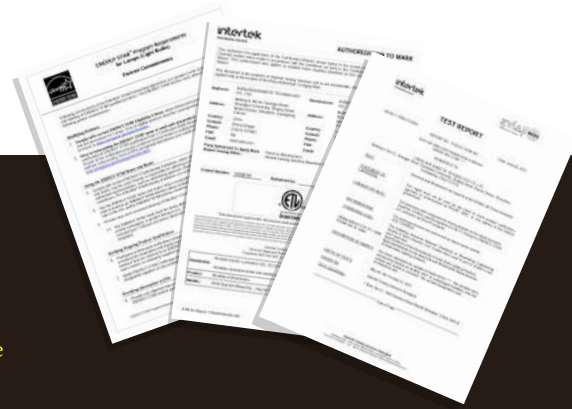

Science park



Reception

Company face



Precision instrument room



Production line 1



Production line 2



Warehouse

Advanced LGP (light guide panel)
side-emitting technique
provides a larger and powerful
eye-caring light

RBT-DL-A101



LED Desk Lamp

This lamp can change color temperature from warm white to daylight to suit your preference throughout the day. The lamp is dimming to 8 settings. It is lightweight and portable making it an ideal companion to take to classes or when traveling. The twistable shade allows you to direct the light where you need it.

TEL : 86-18823393285

Email: swallow@srbt.com

Shenzhen RuiBeiTe Technology Co., Ltd



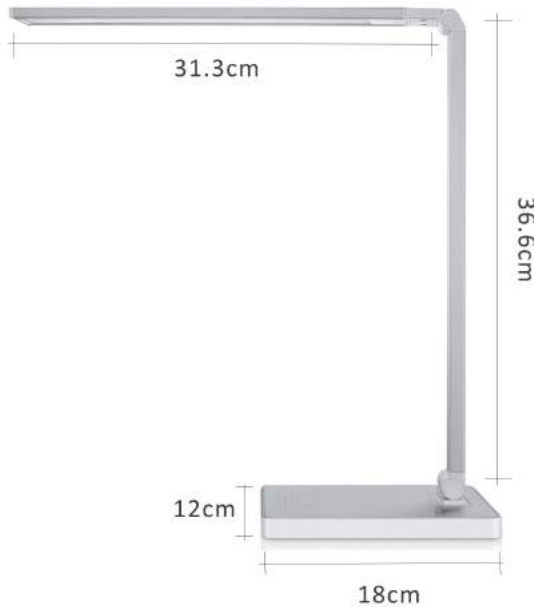

Electrical parameters

Input Voltage	AC100-240V, 50/60Hz
Working Voltage	DC12V, 1A
Power	8W

Light source parameters

LED Chips	Epistar 4014
Luminous Flux	480Lm
CCT	3000K / 4000K / 5000K / 6000K
Lighting Range	1150Lux at 40cm height
CRI	≧ 85
Lifespan	50,000hrs

Material

Lamp Head Material	Aluminum +LGP (Light Guide Plate)
Arm Material	Aluminum
Base Material	ABS

Color

Color	Silver / Black
-------	----------------

Product Description

Features :

1. Advanced LGP (light guide panel) side-emitting technique provides a larger and powerful eye-caring light without harsh glare or ghosting. More pleasant, less fatigue!
2. Touch Control with 4 Lighting Modes + 8-level Dimmer, perfectly suit your activities.
 - 3200K Warm White light to prepare for bed time.
 - 4200K Natural White light to relax.
 - 5200K Pure White light for reading.
 - 6200K Cool White light ideal for studying.
3. Ultra-low voltage input and lighting temperature for absolute safety.
4. LED panel arm can be adjusted up to 200°and can spin up to 240°.
5. 12V/1A approved adapter

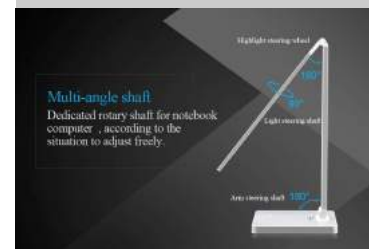

Application :

Study, Office, Bedroom, Bedside, etc.



Foldable, zero ultraviolet
and Flicker free lamp
for reading/study/work.

RBT-DL-D102



LED Desk Lamp

Designed with a wispy-thin silhouette,D102 provides a beautiful linear light source for your desk.Cordless joint design and sleek,clean lines,perfect in any setting.Ultra-efficient LEDs generate little heat and allow to operate within safe temperatures& without the need for eyesore heat sink fins.All components are housed inside a simple right-angled shape,keep a clean silhouette that is easy on the eyes.Change your phone,tablet,or any USB device with Built-in USB port.Stepless brightness dimming and changeable color temperature.

TEL : 86-18823393285

Email: swallow@srbt.com

Shenzhen RuiBeiTe Technology Co., Ltd



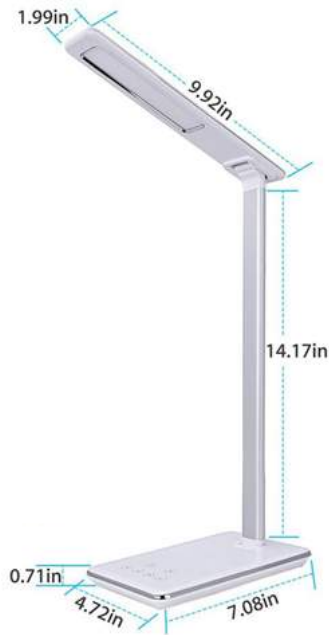

Electrical parameters

Input Voltage	AC100--240V,50/60Hz
Working Voltage	DC5V,2A
Power	5W

Light source parameters

LED Chips	Epistar 4014
Luminous Flux	250Lm
CCT	3000K, 4000K, 5000K, 6000K
Lighting Range	600Lux at 40cm height
CRI	≧ 80
Lifespan	50,000hrs

Material

Lamp Head Material	PC +LGP (Light Guide Plate)
Arm Material	Aluminum
Base Material	ABS

Color

Color	Whiter / Black
-------	----------------

Product Description

Features :

1. USB charging port
2. Timer power-off: you can set 1 hour or 2 hours auto timer mode.
 - . 5V/2A UL approved adapter for whole lamp
3. Touch Control with 4 Lighting Modes + stepless Dimmer, perfectly suit your activities.
 - 3000K Warm White light to prepare for bed time.
 - 4000K Natural White light to relax.
 - 5000K Pure White light for reading.
 - 6000K Cool White light ideal for studying.

Application :

Study, Office, Bedroom, Bedside, etc.

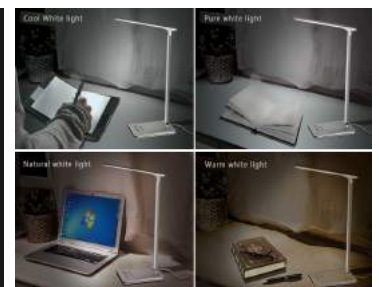
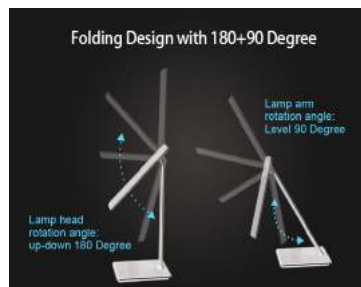

Foldable, zero ultraviolet
and Flicker free lamp
for reading/study/work.

RBT-DL-D102W



LED Desk Lamp

Delivering a phenomenal 50 lumen per watt efficiency. It changes light colors from warm to cool and anything in between. An intuitive built-in touch strip allows for effortless continuous dimming. Built-in occupancy sensor ensures no energy is wasted lighting up a vacant desk (Auto timer off 1h or 2h). For smart phone enthusiasts. It comes standard with a USB port, or optionally a wireless charging base is available for recharging Qi-compatible mobile devices.

TEL : 86-18823393285

Email: swallow@szrbt.com

Shenzhen RuiBeiTe Technology Co., Ltd





Electrical parameters

Input Voltage	AC100--240V,50/60Hz
Working Voltage	DC5V,2.5A
Power	5W
The Efficiency Of Charging	75%
Charging Distance	≤8MM

Light source parameters

LED Chips	Epistar 4014
Luminous Flux	250Lm
CCT	3000K, 4000K, 5000K, 6000K
Lighting Range	600Lux at 40cm height
CRI	≥ 80
Lifespan	50,000hrs

Material

Lamp Head Material	PC +LGP (Light Guide Plate)
Arm Material	Aluminum
Base Material	ABS

Color

Color	Whiter / Black
-------	----------------

Product Description

Features :

1. USB charging port
2. Timer power-off: you can set 1 hour or 2 hours auto timer mode.
 - . Wireless charging, compatible with all Qi-enabled devices.
 - . 5V/2.5A UL approved adapter for whole lamp
 - . The Efficiency Of Charging 75%
 - . Charging Distance:≤8MM
3. Touch Control with 4 Lighting Modes + stepless Dimmer, perfectly suit your activities.
 - 3000K Warm White light to prepare for bed time.
 - 4000K Natural White light to relax.
 - 5000K Pure White light for reading.
 - 6000K Cool White light ideal for studying.

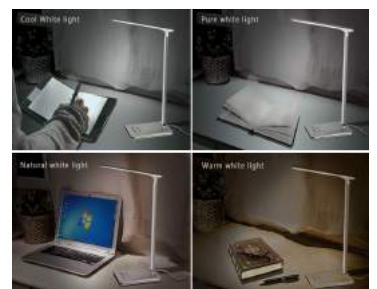

Application :

Study, Office, Bedroom, Bedside, etc.

Non-Flicking
Eye-Care, Zero-Radiation
No dark area
No ghosting, No glaring

RBT-DL-D106

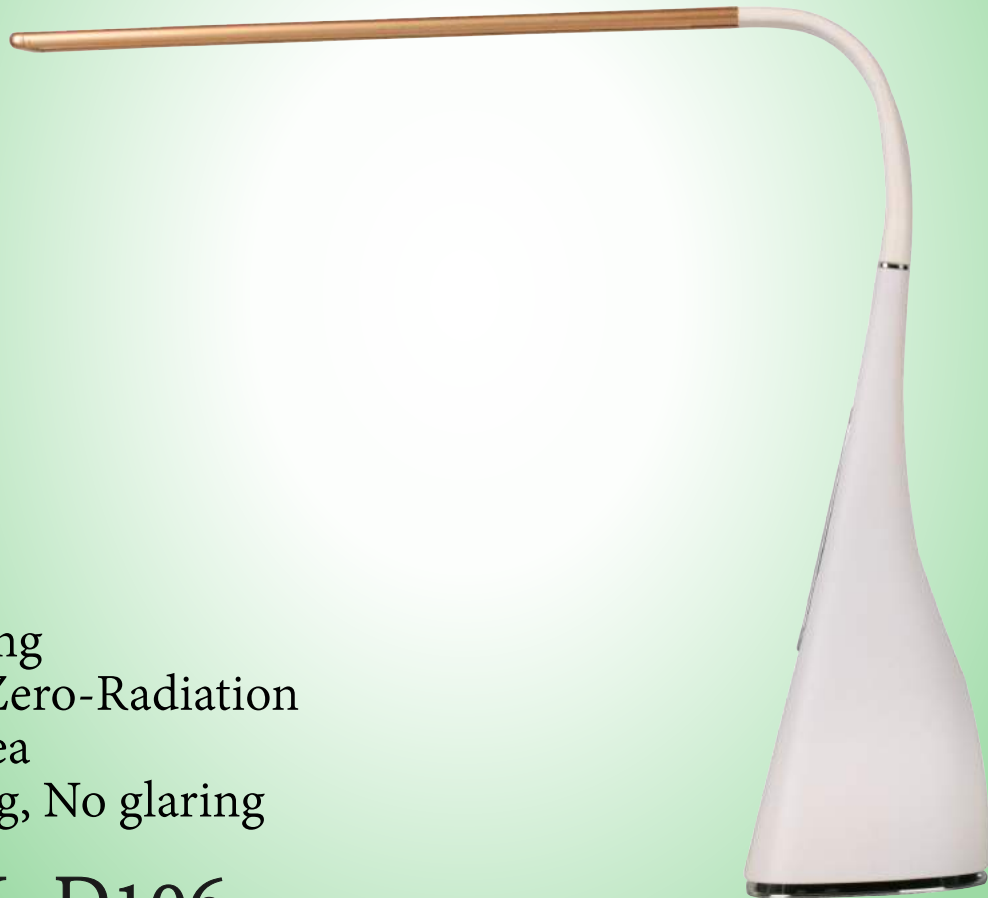

LED Desk Lamp

Fantastic LED Desk Lamp with Blade adjustable
Silica gel , Dimmable Light Dimmer Function, 5 Level dimming touch
switch with LED panel , Energy-Efficient, Non-Flickering for Reading, Bulit
in fan , Adjustable Neck,.Fashion design

TEL : 86-18823393285

Email: swallow@srbt.com

Shenzhen RuiBeiTe Technology Co., Ltd





Electrical parameters

Input Voltage	AC100--240V,50/60Hz
Working Voltage	DC12V,2A
Power	8W

Light source parameters

LED	120pcs,Epistar 4014 SMD LED
Luminous	500LM
CCT	3000K/4000K / 5000K/6000k
Lighting Range	40cm 1200lux
CRI	≥ 80
Brightness	touch dimmable
lamp Lifespan	>50,000hrs
Material	Aluminum + Silica gel+PC

Color

Color	Golden / White
-------	----------------

Product Description

Features :

1. Touch dimmable
2. Non-Flicking, Eye-Care, Zero-Radiation, No dark area, No ghosting, No glaring.
3. Maintains over 50,000 hours of full lumen output, delivers outstanding power-saving performance.
4. Ultra-low voltage input and lighting temperature for absolute safety.

Application :

Study, Office, Bedroom, Bedside, etc.





Light source adopts the secondary optical technology The light is downy uniform evenly without spots foldover.

RBT-DL-D108

LED Desk Lamp

Light up large work areas, like your home office, craft room or a living room couch. multi-angle adjustable Silica gel built-in Battery ,high level golden led desk lamp, special elliptical logo design, surface light source, eye protective led desk lamp This lamp gives you plenty of bright daylight(TM) light for comfortable crafting and reading. With the adjustable silica gel, you can swiftly direct the light exactly where you need it. The slim head design gives you perfect lighting conditions, with optimal shadow free lighting. This lamp comes with bright daylight LED's which are energy saving and reduces eye strain and gives you true color matching.

TEL : 86-18823393285

Email: swallow@szrbt.com

Shenzhen RuiBeiTe Technology Co., Ltd





Electrical parameters

Input Voltage	AC100--240V,50/60Hz
Working Voltage	DC5V,1A
Power	5W

Light source parameters

LED Chips	Epistar 4014
Lumen	Max180 Lm
CCT	3000k/4000k/5000k/6000k
Lighting Range	800Lux at 40cm height
Lifespan	50,000hrs

Material

Lamp Head Material	PC +LGP (Light Guide Plate)
Arm Material	ABS+PC
Base Material	ABS+PC

Color

Color	Golden
-------	--------

Product Description

Features:

1. Fashionable Design.
2. Light source adopts the secondary optical technology
The light is downy uniform evenly without spots foldover.
To adopt advanced technology of constant current.
No stroboscopic,protect eyesight.
3. Light Adjustable Within 40 cm Heights.
Lamp Head Can be 25°-225°.

Application:

4. Study,Office,Bedroom,Bed-side,etc.

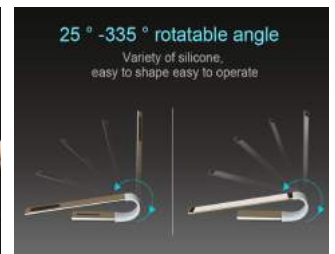

Certification test

This lamp meets the international safety certification standards, in line with electrical safety, optical mold safety and electromagnetic standards



Non-Flicking, Eye-Care
Zero-Radiation
No dark areaNo ghosting
No glaring.

RBT-DL-F201

Arm-mounted LED Table Lamps

Brighten up your desk or station with this LED desk lamp!
This ultra slim task light is energy efficient using LED technology and provides a strong focused light. The very bright light emits true colored lighting but customers do not feel the heat because of the LED technology. Technicians also like the light clarity and seeing the fine details of their work. The flexible arm easily adjusts and the clamp secures tightly on any table/desk with a clamp or base. Dimming Brightness and four color temperature fulfill many kind of task.

TEL : 86-18823393285

Email: swallow@szrbt.com

Shenzhen RuiBeiTe Technology Co., Ltd





Electrical parameters

Input Voltage	AC100--240V, 50/60Hz
Working Voltage	DC12V,1A
Power	8W

Light source parameters

LED Chips	Epistar 4014
Luminous Flux	420lm
CCT	3000K, 4000K, 5000K, 6000K
Lighting Range	1300Lux at 40cm height
CRI	≥ 85
Lifespan	50,000hrs

Material

Lamp Head Material	Die casting Aluminum + LGP (Light Guide Plate)
Arm Material	Aluminum
Base Material	Metal

Color

Color	Silver / Black
-------	----------------

Product Description

Features :

1. Made of die casting aluminum.
2. Touch Control Panel
3. Non-Flicking, Eye-Care, Zero-Radiation, No dark area, No ghosting, No glaring.
4. Maintains over 50,000 hours of full lumen output, delivers outstanding power-saving performance.
5. Ultra-low voltage input and lighting temperature for absolute safety.
6. Super Bright, Beam Angle more than 160°.
7. LED panel arm can be adjusted up to 200° and can spin up to 240°, Lamp Arm can 130° stretched.



Application :

Study, Office, Bedroom, Bedside, etc.



Non-Flicking, Eye-Care,
Zero-Radiation, No dark area,
No ghosting, No glaring.

RBT-DL-C201

Arm-mounted LED Table Lamps

This unique, stylish slimline task lamp with clamp is ideal for all your detailed work. The bright Daylight LED's are low heat so comfortable to work with and no heat in your clients face. With a slimline head and adjustable internal spring arm you can position the lamp easily with one hand exactly where you need the light.

TEL : 86-18823393285

Email: swallow@srbt.com

Shenzhen RuiBeiTe Technology Co., Ltd





Electrical parameters

Input Voltage	AC100--240V,50/60Hz
Working Voltage	DC12V,1A
Power	9W

Light source parameters

LED Chips	Epistar 4014
Luminous Flux	420LM
CCT	4000K / 6000k
Lighting Range	600Lux at 40cm height
CRI	≥ 90
Lifespan	50,000hrs

Material

Lamp Head Material	Aluminum + LGP (Light Guide Plate)
Arm Material	Aluminum
Base Material	Metal

Color

Color	Silver / Black
-------	----------------

Product Description

Features :

- 1.Made of die casting aluminum.
- 2.Touch control.
- 3.Non-Flicking, Eye-Care, Zero-Radiation, No dark area, No ghosting, No glaring.
- 4.Maintains over 50,000 hours of full lumen output, delivers outstanding power-saving performance.
- 5.Ultra-low voltage input and lighting temperature for absolute safety.
- 6.Super Bright, Beam Angle more than 160°.
- 7.LED panel arm can be adjusted up to 200°and can spin up to 200°, Lamp Arm can 180°stretched.

Application :

Study, Office, Bedroom, Bedside, etc.

Touch control stepless dimming



Fine craft, high-grade aluminum alloy body

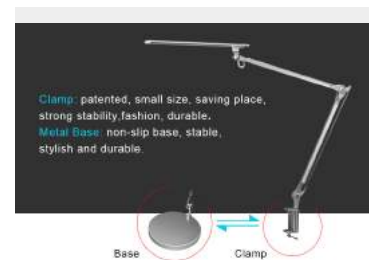

Stepless dimming
touch control smart 11W
super powerful
LED desk Lamp.

RBT-DL-O201



Arm-mounted LED Table Lamps

This lamp is perfect for drawing or writing at a desk. The multi-angle head joint allows you to position the light exactly where you need it and as the PL desk lamp is supplied with both clamp and table base, you can use it on any work area. This lamp comes with an 11W daylight energy saving tube (220W equiv.) for the best quality of light. Available in Black or Silver.

TEL : 86-18823393285

Email: swallow@szrbt.com

Shenzhen RuiBeiTe Technology Co., Ltd





Electrical parameters

Input Voltage	AC100--240V, 50/60Hz
Working Voltage	DC12V, 1A
Power	11W

Light source parameters

LED Chips	Epistar 2835 SMD
Luminous Flux	650lm
CCT	4000K / 6000K
Lighting Range	800Lux at 45cm height
CRI	≥ 83
Lifespan	50,000hrs

Material

Lamp Head Material	Die casting Aluminum + LGP (Light Guide Plate)
Arm Material	Aluminum
Base Material	Metal

Color

Color	Silver / Black
-------	----------------

Product Description

Features :

1. Made of die casting aluminum.
2. Stepless dimming touch control smart 11W super powerful LED desk Lamp
3. Non-Flicking, Eye-Care, Zero-Radiation, No dark area, No ghosting, No glaring.
4. Maintains over 50,000 hours of full lumen output, delivers outstanding power-saving performance.
5. Ultra-low voltage input and lighting temperature for absolute safety.
6. Super Bright, Beam Angle more than 160°.
7. LED panel arm can be adjusted up to 170° and can spin up to 200°, Lamp Arm can 200° stretched.



Application :

Study, Office, Bedroom, Bedside etc.



Eye-protection 11W
LED Desk Lamp
RBT-DL-E01

LED Desk Lamp

E01 side light technology into a minimal light engine to deliver 650 lumens while using only 10 watts of power. With a CRI of 80 and a CCT of 4000K or 6000k, It provides brilliant, uniform light for up to 50,000 hours - or the equivalent of 25 years in an average work environment. And with a clever folding mechanism, It is as convenient as it is beautiful. Through the use of revolutionary Thin Film LED Technology, E01 produces a consistent ultra-wide light footprint. This new technology not only provides ample amounts of bright 4000K light that helps reduce eye strain, but also increases the lamp's usable life. RBT's smart dimming feature provides adjustable illumination levels for energy-efficiency and ergonomic function. Intelligent and intuitive

TEL : 86-18823393285

Email: swallow@szrbt.com

Shenzhen RuiBeiTe Technology Co., Ltd





Electrical parameters

Input Voltage	100-240V, 50/60Hz
Output Voltage	DC12V, 1A
Max power consumption	11W

Light source parameters

LED	96pcs Epistar 2835 SMD LED
Luminous Flux	650LM
Brightness	Stepless dimming touch control
Lighting Range	800lux at 45cm
CCT	4000K / 6000K
CRI	≧ 83
LED Lifetime	>50,000 hours

Material

Material	Die casting aluminum + Metal
----------	------------------------------

Color

Color	Silver / Black
-------	----------------

Product Description

Features :

1. Made of die casting aluminum
2. Touch control
3. Close to daylight illumination, diffusion panel emitting soft light without ghost, glare or flicker.
4. Maintains over 50,000 hours of full lumen output, delivers outstanding power-saving performance.
5. Circular surface light source, even light, large lighting area

Touch control to adjust brightness
More comfortable tactility, longer lifespan



Show details

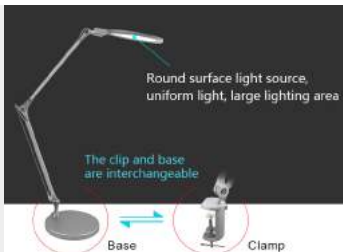

Eliminate low strobe
Strobe is caused by damage to the eye optical system. Visual fatigue. The main reason for myopia



Application :

Study, Office, Bedroom, Bedside etc.

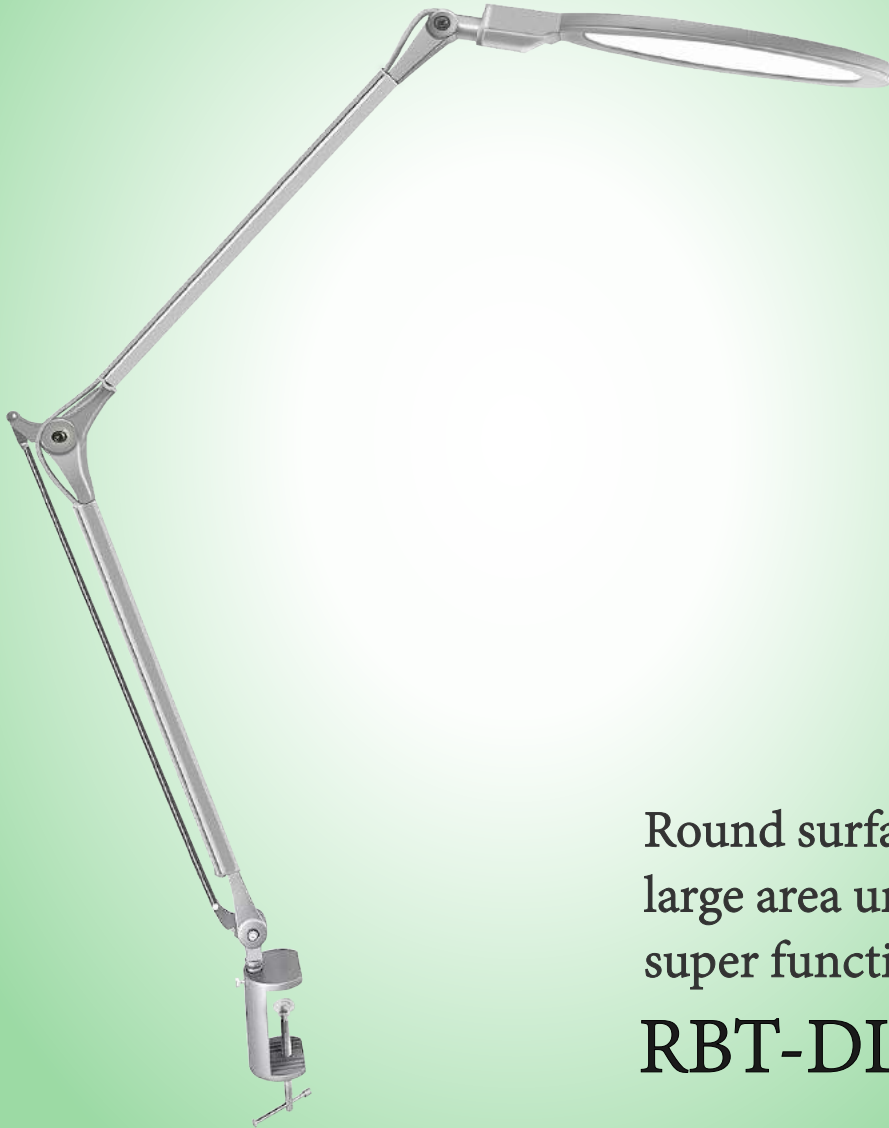

Round surface light source,
large area uniform light
super function LED lamp
RBT-DL-E201

LED Desk Lamp

The RBT E201 task light is Our response to the need for intelligent workspace lighting. Intuitive and flexible, the RBT E201 combines high performance ergonomic design with 270 degrees of adjustability and unprecedented functionality in LED task lamps. A revolutionary task light, the E201 delivers the equivalent of light from a 90W incandescent using less than 10W of power. E201 feature a unique, heat sink design to maximize light output and increase the light's usable life. An internal counterbalance provides effortless, one-touch positioning for comfort and complete ease of use. Providing high performance in an adjustable LED task light, the E201 uses a single light source that casts just one shadow. It comes in a variety of finishes, with 2 mounting options available to tailor it to any work environment.(Clamp Or Base) It is also dimmable to allow for optimal light settings. A universal power supply and interchangeable plug options accommodate global power outlets

TEL : 86-18823393285

Email: swallow@szrbt.com

Shenzhen RuiBeiTe Technology Co., Ltd





Electrical parameters

Input Voltage	100-240V, 50/60Hz
Output Voltage	DC12V, 1A
Max power consumption	11W

Light source parameters

LED	96pcs Epistar 2835 SMD LED
Luminous Flux	650LM
Brightness	Stepless dimming touch control
Lighting Range	45cm 800lux
CCT	4000K / 6000K
CRI	≥ 83
LED Lifetime	>50,000 hours

Material

Material	Die casting aluminum + Metal
----------	------------------------------

Color

Color	Silver / Black
-------	----------------

Product Description

Features :

1. Made of die casting aluminum
2. Touch control
3. Close to daylight illumination, diffusion panel emitting soft light without ghost, glare or flicker.
4. Maintains over 50,000 hours of full lumen output, delivers outstanding power-saving performance.
5. Circular surface light source, even light, large lighting area

Touch control to adjust brightness
More comfortable tactility, longer lifespan



Show details



Eliminate low strobe
Stroke is caused by damage to the eye optical system. Visual fatigue. The main reason for myopia



Application :

Study, Office, Bedroom, Bedside etc.



Eye protection,
Zero radiation
No ghosting No glare
RBT-DL-H201

LED Desk Lamp

The LED Light series is the latest innovation in energy efficient task lighting. Precision machined components house the latest in high brightness LED technology and ultra-smooth dimming control. Exceptionally designed for years of continuous and reliable use.

RBT® clamp task lamps are supplied with 10 watt daylight leds (3000°K-6000°K). Your choice of four light models. The RBT Floating Arm is easily positioned with a touch of a finger and will stay where you put it without springs or tightening screws. Rugged all metal construction has no exposed springs or wires. Now finished with powder coat for years of lasting use. Available in several colors, desk base models, clamp models, and two arm lengths. Clamp models will also fit into most of adjustable desk, bench-friendly.

TEL : 86-18823393285

Email: swallow@szrbt.com

Shenzhen RuiBeiTe Technology Co., Ltd





Electrical parameters

Input Voltage	AC 100-240V 50/60Hz
Output Voltage	DC 12V/1A
Power	10W

Light source parameters

LED	120 pcs LED 4014
Luminous Flux	750lm
Brightness	Stepless dimmer
Lighting Range	1450Lux at 40 cm height
CCT	2800K/3500/4700K/6000K
CRI	Ra≥80

Material

Material	Die casting aluminum + Metal
----------	------------------------------

Color

Color	Silver
-------	--------

Product Description

Features :

1. Made of die casting aluminum
2. Rotate to adjust brightness
3. Close to daylight illumination, diffusion panel emitting soft light without ghost, glare or flicker.
4. Maintains over 50,000 hours of full lumen output, delivers outstanding power-saving performance.

Application :

Study, Office, Bedroom, Bedside etc.





Non-Flicking, Eye-Care
Zero-Radiation
No dark area No ghosting
No glaring.

RBT-FL-F201

Arm-mounted LED Floor Lamps

RBT Lighting F201-F LED floor lamp features energy efficient LED and available in metallic black or silver finishes.

Delivering a phenomenal 420 lumen per watt efficiency, It changes light colors from warm to cool and anything in between. An intuitive built-in touch strip allows for effortless continuous dimming. Built-in occupancy sensor ensures no energy is wasted lighting up a vacant desk or reading area. Highly adjustable arms and lamp head, point your light at any angle you desire.

TEL : 86-18823393285

Email: swallow@srbt.com

Shenzhen RuiBeiTe Technology Co., Ltd



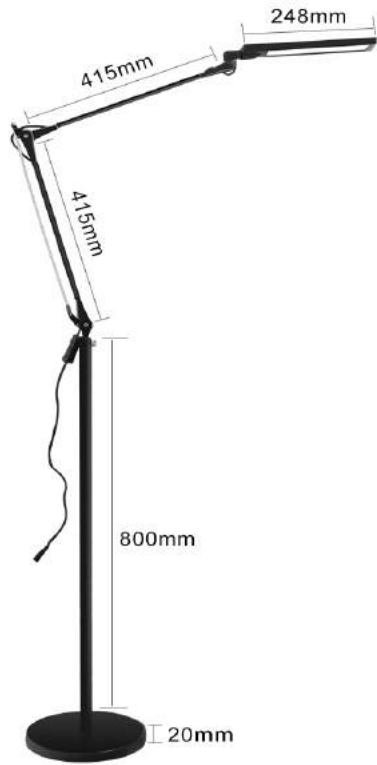

Electrical parameters

Input Voltage	AC100--240V, 50/60Hz
Working Voltage	DC12V,1A
Power	8W

Light source parameters

LED Chips	Epistar 4014
Luminous Flux	420lm
CCT	3000K, 4000K, 5000K, 6000K
CRI	≥ 85
Lifespan	50,000hrs

Material

Lamp Head Material	Die casting Aluminum + LGP (Light Guide Plate)
Arm Material	Aluminum
Base Material	Metal

Color

Color	Silver / Black
-------	----------------

Product Description

Features :

1. Made of die casting aluminum.
2. Touch Control Panel
3. Non-Flicking, Eye-Care, Zero-Radiation, No dark area, No ghosting, No glaring.
4. Maintains over 50,000 hours of full lumen output, delivers outstanding power-saving performance.
5. Ultra-low voltage input and lighting temperature for absolute safety.
6. Super Bright, Beam Angle more than 160°.
7. LED panel arm can be adjusted up to 200° and can spin up to 240°, Lamp Arm can 130° stretched.



Application :

Study, Office, Bedroom, Bedside, etc.



Non-Flicking, Eye-Care,
Zero-Radiation, No dark area,
No ghosting, No glaring.

RBT-FL-C201

Arm-mounted LED Floor Lamps

RBT Lighting C201 Small LED Floor Lamp features multiple finishes. White, Silver, Black, Orange, or Green. 360° rotation at base.

Fusing breakthrough LED technology with a uniquely tactile and calibrated light control experience, C201-F is an intelligent, precise and effortlessly adjustable task lamp. A user can tune it to any beam spread, brightness and direction, controlling the volume and focus of light. The aluminum shade on the lamp's arm enables much of this adjustability, enabling the user to fluidly dial it around the light source to guide the beam in any direction.

It's wide range of models includes both small and medium lamp bodies that can be fitted over table, floor, clamp, and Metal base options for residential, office and hospitality settings.

TEL : 86-18823393285

Email: swallow@szrbt.com

Shenzhen RuiBeiTe Technology Co., Ltd





Electrical parameters

Input Voltage	AC100--240V,50/60Hz
Working Voltage	DC12V,1A
Power	9W

Light source parameters

LED Chips	Epistar 4014
Luminous Flux	420LM
CCT	4000K / 6000k
CRI	≥ 90
Lifespan	50,000hrs

Material

Lamp Head Material	Aluminum + LGP (Light Guide Plate)
Arm Material	Aluminum
Base Material	Metal

Color

Color	Silver / Black
-------	----------------

Product Description

Features :

- 1.Made of die casting aluminum.
- 2.Touch control.
- 3.Non-Flicking, Eye-Care, Zero-Radiation, No dark area, No ghosting, No glaring.
- 4.Maintains over 50,000 hours of full lumen output, delivers outstanding power-saving performance.
- 5.Ultra-low voltage input and lighting temperature for absolute safety.
- 6.Super Bright, Beam Angle more than 160°.
- 7.LED panel arm can be adjusted up to 200°and can spin up to 200°, Lamp Arm can 180°stretched.

Application :

Study, Office, Bedroom, Bedside, etc.

Touch control stepless dimming



Stepless dimming
touch control smart 11W
super powerful
LED desk Lamp.

RBT-FL-O201



Arm-mounted LED Floor Lamps

RBT Lighting O201-F LED Floor Lamp features touch to control brightness and power and available in three finishes.

This Floor Lamp brings the discreet counterweight design for feather-light adjustability of floor lamp without the need for a table / desk. put your finger along the stem's touch strip to control brightness and power. The special neck joint maintains the head's tilt as the arm swings up or down. The luminaire head is rotatable in 160 degrees and is detachable for easy replacement. Compatible with optional occupancy sensor.

TEL : 86-18823393285

Email: swallow@szrbt.com

Shenzhen RuiBeiTe Technology Co., Ltd



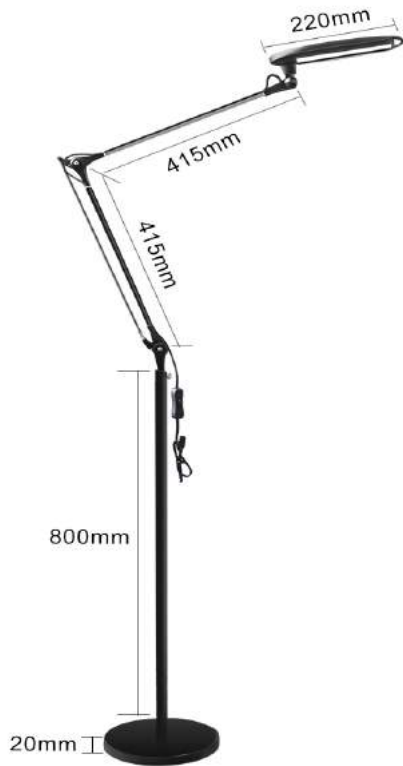

Electrical parameters

Input Voltage	AC100--240V, 50/60Hz
Working Voltage	DC12V, 1A
Power	11W

Light source parameters

LED Chips	Epistar 2835 SMD
Luminous Flux	650lm
CCT	4000K / 6000K
CRI	≥ 83
Lifespan	50,000hrs

Material

Lamp Head Material	Die casting Aluminum + LGP (Light Guide Plate)
Arm Material	Aluminum
Base Material	Metal

Color

Color	Silver / Black
-------	----------------

Product Description

Features :

1. Made of die casting aluminum.
2. Stepless dimming touch control smart 11W super powerful LED desk Lamp
3. Non-Flicking, Eye-Care, Zero-Radiation, No dark area, No ghosting, No glaring.
4. Maintains over 50,000 hours of full lumen output, delivers outstanding power-saving performance.
5. Ultra-low voltage input and lighting temperature for absolute safety.
6. Super Bright, Beam Angle more than 160°.
7. LED panel arm can be adjusted up to 170° and can spin up to 200°, Lamp Arm can 200° stretched.

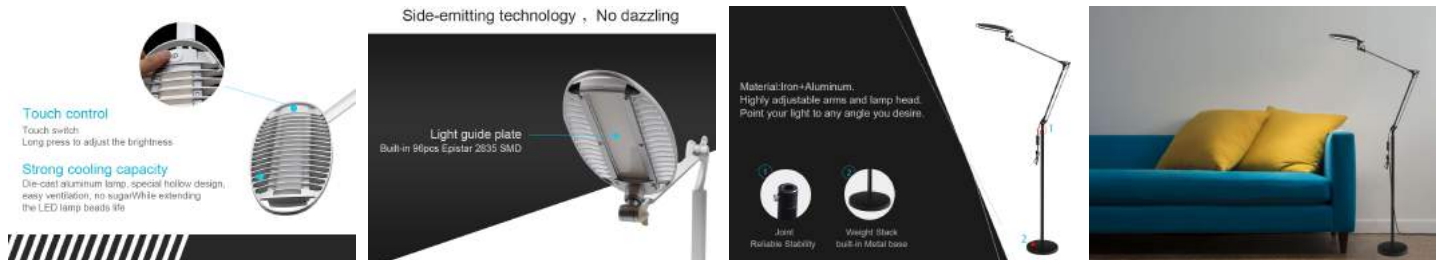

Application :

Study, Office, Bedroom, Bedside etc.



Shenzhen RuiBeiTe Technology Co., Ltd

TEL: 86-18823393285

FAX:+86-0755-22705980-801

Email: swallow@srbt.com

Address: Building A, NO.52, Huangpu Road, Shajing Street,
Bao'an District, Shenzhen, Guangdong, China