



NANTONG CHENGXIN OPTICAL INSTRUMENT CO.,LTD

2020



Nantong Chengxin Optical Instrument CO., LTD

As one of the professional manufacturer of rifle scope, red dot sight, laser sight and other hunting accessories, Spike possess our own R&D, quality control professionals as well as after-sales service.

Since the year 1990, Spike has been a leader in bringing excellent quality, attractive design, timely delivery and competitive price to all of our distributors as well as OEM & ODM customers. Our company covers a total area of over 30,000 square meters, in which floor area is 20,000 square meters.

28 years' production brings us a huge experience. 3 branches are our production basis. More than 500 employees provide timely delivery. Over 180 R&D engineers are our technical supports. Professionally trained salesmen provide you our best service.

Our professional team is right here waiting for you!

CONTENTS



1. Reflex Red Dot Sight 3-12



2. Magnifier 13



3. Enclosed Red Dot Sight 14-23



4. Laser Sight 24-29



5. Laser Bore Sight 30-31



6. Scope of ZL/VT Series 32-34



7. Scope of CL/JL Series 35-36



8. Scope of TMD Series 37-38



9. Scope of ZS MC HK HL Series 39-44



10. Scope of MA/FFP&SWAT Series 45-46



11. Short Scope with Laser Series 47-50



12. Scope of PRISM Series 51-52



13. Scope of Long Eye Relief Series 53-55
Scope of AOEYS Series



14. Scope of AOL Series 56-57



15. Scope of AOIR Series 58-59



16. Scope of AOEG Series 60-62



17. Scope of COMMON Series 63-69



18. Combo Scope & Mount 70-80
Scope of AN Series



HD1580

Fixed focus is best for use on pistols, ARs and hunting rifles. The auto light sense makes it easy to control the light. The lightweight construction and unlimited eye relief permits the effective use of this optic on virtually any platform equipped with a Weaver or Picatinny base.



HD109

Offering the user 4 tactical reticle options, the shooter can switch between them without tools, and while the optic is mounted. The special red and green illumination control buttons are both for light color change and light shut off.



HD556K

The product is ideal for close-range, fast-moving targets. It can improve target acquisition, boost accuracy and increase control over the shooting environment. It is built to last, with a rugged aluminum hood assembly and knobbed, tool-free mounting bolt. Shooters can take advantage of its quick-detach mount for easy removal when iron sights or other accessories are used.



HDM1AQ

Designed with an integral weaver or picatinny base, the micro dot offers all the advantages of a reflex sight in an extra compact package. The special red and green illumination control buttons are both for light color change and light shut off. The shooter can take use of the bar on top of the turret cap to make W/E adjustments.

MODEL NO.	MAGNIFICATION	ILLUMINATION	OBJECTIVE	DOT SIZE
HD1075	1X	R	24MM	1MOA
HD556K	1X	R/G	32MM	3MOA

MODEL NO.	MAGNIFICATION	ILLUMINATION	OBJECTIVE	DOT SIZE
HD109	1X	R/G	34MM	3MOA
HDM1AQ	1X	R/G	20MM	4-5MOA

FOG RESISTANT



WATER RESISTANT



IMPACT RESISTANT





HD101D

Offering the user 4 tactical reticle options, the shooter can switch between them without tools, and while the optic is mounted. The special red and green illumination control buttons are both for light color change and light shut off. The easy battery inserting compartment makes it a special design.



HD1075

Fixed focus is best for use on pistols, ARs and hunting rifles. The on/off button makes it easier to control the illumination intensity. The lightweight construction and unlimited eye relief permits the effective use of this optic on virtually any platform equipped with a Weaver or Picatinny base.



HD1076

Fixed focus is best for use on pistols, ARs and hunting rifles. The on/off button makes it easier to control the illumination intensity. The lightweight construction and unlimited eye relief permits the effective use of this optic on virtually any platform equipped with a Weaver or Picatinny base.



HD22L

Designed with an integral weaver or picatinny base, the micro dot offers all the advantages of a reflex sight in an extra compact package. The special red and green illumination control buttons are both for light color change and light shut off. It is perfect for both long guns and handguns.

MODEL NO.	MAGNIFICATION	ILLUMINATION	OBJECTIVE	DOT SIZE
HD101D	1X	R/G	34MM	3MOA
HD1076	1X	R	24MM	1MOA

MODEL NO.	MAGNIFICATION	ILLUMINATION	OBJECTIVE	DOT SIZE
HD1075	1X	R	24MM	1MOA
HD22L	1X	R/G	20MM	4-5MOA

FOG RESISTANT



WATER RESISTANT



IMPACT RESISTANT





3-9X40V



1-6X24IR

MODEL	MAGNIFICATION	ILLUMINATION	TUBE DIAMETER	OBJECTIVE	EYE RELIEF	LENS COATING	LENGTH	WEIGHT	BATTERY
3-9X40V	3-9x	RED & GREEN	25.4mm	40mm	250-300mm	FMC	230mm	380g	CR2032
1-6X24IR	1-6x	RED & GREEN	30mm	24mm	85-100mm		257mm	655g	CR2032

RETICLE OPTIONS

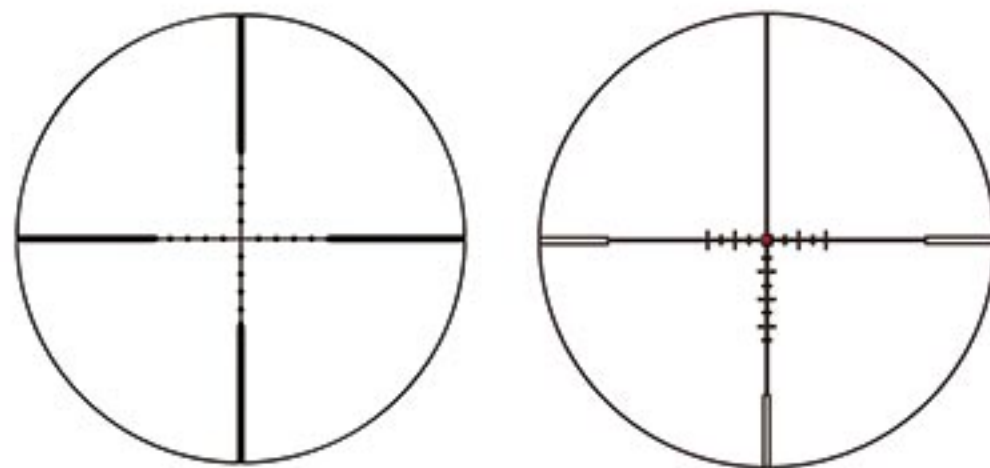

RETICLE COLORS



FOG RESISTANT



WATER RESISTANT



IMPACT RESISTANT





1-6X24



1.5-5X32IR



SF 6-24X50

MODEL	MAGNIFICATION	ILLUMINATION	TUBE DIAMETER	OBJECTIVE	EYE RELIEF	LENS COATING	LENGTH	WEIGHT	BATTERY
1-6X24	1-6x	RED & GREEN	30mm	24mm	85-100mm	FMC	257mm	670g	CR2032
1.5-5X32IR	1.5-5x	RED & GREEN	30mm	32mm	85-100mm		211mm	405g	CR2032
SF 6-24X50	6-24x		30mm	50mm	76-89mm		354mm	675g	

RETICLE OPTIONS



RETICLE COLORS



FOG RESISTANT



WATER RESISTANT



IMPACT RESISTANT





Tubeless design with 33mm reflex lens aperture provides a wide field of view, suitable for rapid-firing or shooting of moving targets besides normal shooting. Multi-Reticle (4 patterns) or Variable Dot (4 different sizes) are installed.

Parallax corrected and unlimited eye-relief, Allen head screw type windage and elevation click adjustments with locking screw.

Built-in mount (integrated rail) for standard bases, no need to rezero when remounting the dismounted sight.

Very light weight, shockproof. Low power consumption for long battery life.





HD101

Offering the user 4 tactical reticle options, the shooter can switch between them without tools, and while the optic is mounted. The lightweight construction and unlimited eye relief permits the effective use of this optic on virtually any platform equipped with a Weaver or Picatinny base.



HD101Y

Offering the user 4 tactical reticle options, the shooter can switch between them without tools, and while the optic is mounted. The silver body gives you a different visual feeling. The lightweight construction and unlimited eye relief permits the effective use of this optic on virtually any platform equipped with a Weaver or Picatinny base.



HD101S

Offering the user 4 tactical reticle options, the shooter can switch between them without tools, and while the optic is mounted. The lightweight construction and unlimited eye relief permits the effective use of this optic on virtually any platform equipped with a Weaver or Picatinny base.

MODEL NO.	MAGNIFICATION	ILLUMINATION	OBJECTIVE	DOT SIZE
HD101	1X	R/G	34MM	3MOA
HD101Y	1X	R/G	34MM	3MOA
HD101S	1X	R/G	34MM	3MOA



HD102

Offering the user 4 tactical reticle options, the shooter can switch between them without tools, and while the optic is mounted. The lightweight construction and unlimited eye relief permits the effective use of this optic on virtually any platform equipped with a Weaver or Picatinny base.



HD103

Offering the user 4 tactical reticle options, the shooter can switch between them without tools, and while the optic is mounted. Easily accessible side mounted rheostat makes quick brightness adjustment possible while shooting on the move. The lightweight construction and unlimited eye relief permits the effective use of this optic on virtually any platform equipped with a Weaver or Picatinny base.



HD103B

Offering the user 4 tactical reticle options, the shooter can switch between them without tools, and while the optic is mounted. Easily accessible side mounted rheostat makes quick brightness adjustment possible while shooting on the move. The red laser is also available for use. The lightweight construction and unlimited eye relief permits the effective use of this optic on virtually any platform equipped with a Weaver or Picatinny base.

MODEL NO.	MAGNIFICATION	ILLUMINATION	OBJECTIVE	DOT SIZE
HD102	1X	R/G	34MM	3MOA
HD103	1X	R/G	33MM	3MOA
HD103B	1X	R/G	33MM	3MOA





HD103C

Offering the user 4 tactical reticle options, the shooter can switch between them without tools, and while the optic is mounted. Easily accessible side mounted rheostat makes quick brightness adjustment possible while shooting on the move. The red laser is also available for use. Multi rail feature makes it easy to install multiple accessories. The lightweight construction and unlimited eye relief permits the effective use of this optic on virtually any platform equipped with a Weaver or Picatinny base.



HD104

Offering the user 4 tactical reticle options, the shooter can switch between them without tools, and while the optic is mounted. The on/off button makes it easier to control the illumination color and intensity. The lightweight construction and unlimited eye relief permits the effective use of this optic on virtually any platform equipped with a Weaver or Picatinny base.



HD103S

Offering the user 4 tactical reticle options, the shooter can switch between them without tools, and while the optic is mounted. Easily accessible side mounted rheostat makes quick brightness adjustment possible while shooting on the move. The lightweight construction and unlimited eye relief permits the effective use of this optic on virtually any platform equipped with a Weaver or Picatinny base.



HD104QD

Offering the user 4 tactical reticle options, the shooter can switch between them without tools, and while the optic is mounted. The on/off button makes it easier to control the illumination color and intensity. Shooters can take advantage of its quick-detach mount for easy removal when iron sights or other accessories are used. The lightweight construction and unlimited eye relief permits the effective use of this optic on virtually any platform equipped with a Weaver or Picatinny base.



HD103QD

Offering the user 4 tactical reticle options, the shooter can switch between them without tools, and while the optic is mounted. Easily accessible side mounted rheostat makes quick brightness adjustment possible while shooting on the move. Utilizing a quick release mount is textured for easy operation under any conditions, while simultaneously granting the shooter the ability to remove the optic easily for transport or when falling back to iron sights. The lightweight construction and unlimited eye relief permits the effective use of this optic on virtually any platform equipped with a Weaver or Picatinny base.



HD105

Offering the user 4 tactical reticle options, the shooter can switch between them without tools, and while the optic is mounted. The on/off button in the front is convenient to control the illumination. The lightweight construction and unlimited eye relief permits the effective use of this optic on virtually any platform equipped with a Weaver or Picatinny base.

MODEL NO.	MAGNIFICATION	ILLUMINATION	OBJECTIVE	DOT SIZE
HD103C	1X	R/G	33MM	3MOA
HD103S	1X	R/G	33MM	3MOA
HD103QD	1X	R/G	33MM	3MOA

MODEL NO.	MAGNIFICATION	ILLUMINATION	OBJECTIVE	DOT SIZE
HD104	1X	R/G	33MM	3MOA
HD104QD	1X	R/G	33MM	3MOA
HD105	1X	R	34MM	3MOA





HD106

Offering the user 4 tactical reticle options, the shooter can switch between them without tools, and while the optic is mounted. Extended polishing process is for crisp edge to edge clarity and maximum light transmission. The lightweight construction and unlimited eye relief permits the effective use of this optic on virtually any platform equipped with a Weaver or Picatinny base.



HD107R

Fixed focus is best for use on pistols, ARs and hunting rifles. The user has two options for brightness, low and high, with a manual on/off switch. The lightweight construction and unlimited eye relief permits the effective use of this optic on virtually any platform equipped with a Weaver or Picatinny base.



HD107S

Fixed focus is best for use on pistols, ARs and hunting rifles. The user has two options for brightness, low and high, with a manual on/off switch. The lightweight construction and unlimited eye relief permits the effective use of this optic on virtually any platform equipped with a Weaver or Picatinny base.



HD107RG

Fixed focus is best for use on pistols, ARs and hunting rifles. Switch on/off button makes it easy to control the product. Dual illumination makes the reticle color optional. The lightweight construction and unlimited eye relief permits the effective use of this optic on virtually any platform equipped with a Weaver or Picatinny base.



HD107X

Fixed focus is best for use on pistols, ARs and hunting rifles. The user has two options for brightness, low and high, with a manual on/off switch. Extended polishing process is for crisp edge to edge clarity and maximum light transmission. The lightweight construction and unlimited eye relief permits the effective use of this optic on virtually any platform equipped with a Weaver or Picatinny base.



HD108

Offering the user 4 tactical reticle options, the shooter can switch between them without tools, and while the optic is mounted. The lightweight construction and unlimited eye relief permits the effective use of this optic on virtually any platform equipped with a Weaver or Picatinny base.

MODEL NO.	MAGNIFICATION	ILLUMINATION	OBJECTIVE	DOT SIZE
HD106	1X	R/G	34MM	3MOA
HD107S	1X	R	24MM	3MOA
HD107X	1X	R/G	24MM	3MOA

MODEL NO.	MAGNIFICATION	ILLUMINATION	OBJECTIVE	DOT SIZE
HD107R	1X	R	24MM	3MOA
HD107RG	1X	R/G	24MM	3MOA
HD108	1X	R/G	34MM	3MOA





HD108QD

Offering the user 4 tactical reticle options, the shooter can switch between them without tools, and while the optic is mounted. Utilizing a quick release mount is textured for easy operation under any conditions, while simultaneously granting the shooter the ability to remove the optic easily for transport or when falling back to iron sights. The lightweight construction and unlimited eye relief permits the effective use of this optic on virtually any platform equipped with a Weaver or Picatinny base.



HD111B

Offering the user 4 tactical reticle options, the shooter can switch between them without tools, and while the optic is mounted. Extended polishing process is for crisp edge to edge clarity and maximum light transmission. The red laser is also available for use. The lightweight construction and unlimited eye relief permits the effective use of this optic on virtually any platform equipped with a Weaver or Picatinny base.



HD110

Offering the user 4 tactical reticle options, the shooter can switch between them without tools, and while the optic is mounted. The optic frame is rounded to minimize snag and has a robust rheostat knob for quick brightness and color adjustments. The lightweight construction and unlimited eye relief permits the effective use of this optic on virtually any platform equipped with a Weaver or Picatinny base.



HD112

Offering the user 4 tactical reticle options, the shooter can switch between them without tools, and while the optic is mounted. Extended polishing process is for crisp edge to edge clarity and maximum light transmission. Multi rail feature makes it easy to install multiple accessories. The lightweight construction and unlimited eye relief permits the effective use of this optic on virtually any platform equipped with a Weaver or Picatinny base.



HD111

Offering the user 4 tactical reticle options, the shooter can switch between them without tools, and while the optic is mounted. Extended polishing process is for crisp edge to edge clarity and maximum light transmission. The lightweight construction and unlimited eye relief permits the effective use of this optic on virtually any platform equipped with a Weaver or Picatinny base.



HD118

TRI-ILLUMINATED W/T S MOUNT
This scope has a fixed 3 times magnification with a 30mm objective lens. With adjustable reticle illumination which is 3 brightness levels in red, green and blue, allowing for better reticle visibility at night or in low light environments. Lightweight and durable performance exceeds your expectations. It is in black anodized aluminum construction and LED(light emitting diode) is 100% safe for eyes.

MODEL NO.	MAGNIFICATION	ILLUMINATION	OBJECTIVE	DOT SIZE
HD108QD	1X	R/G	34MM	3MOA
HD110	1X	R/G	33MM	3MOA
HD111	1X	R/G	33MM	3MOA

MODEL NO.	MAGNIFICATION	ILLUMINATION	OBJECTIVE	DOT SIZE
HD111B	1X	R/G	33MM	3MOA
HD112	1X	R/G	33MM	3MOA
HD118	1X	R/G	35MM	3MOA





HD119

Offering the user 4 tactical reticle options, the shooter can switch between them without tools, and while the optic is mounted. Easily accessible side positioned brightness adjustments are protected by rubber caps. The lightweight construction and unlimited eye relief permits the effective use of this optic on virtually any platform equipped with a Weaver or Picatinny base.



HD119QD

Offering the user 4 tactical reticle options, the shooter can switch between them without tools, and while the optic is mounted. Easily accessible side positioned brightness adjustments are protected by rubber caps. Utilizing a quick release mount is textured for easy operation under any conditions, while simultaneously granting the shooter the ability to remove the optic easily for transport or when falling back to iron sights. The lightweight construction and unlimited eye relief permits the effective use of this optic on virtually any platform equipped with a Weaver or Picatinny base.



HD120

Offering the user 4 tactical reticle options, the shooter can switch between them without tools, and while the optic is mounted. The cylindrical style provides a perfect sunshade and gives maximum light transmission. The lightweight construction and unlimited eye relief permits the effective use of this optic on virtually any platform equipped with a Weaver or Picatinny base.



HD121

Offering the user 4 tactical reticle options, the shooter can switch between them without tools, and while the optic is mounted. The cylindrical style provides a perfect sunshade and gives maximum light transmission. The lightweight construction and unlimited eye relief permits the effective use of this optic on virtually any platform equipped with a Weaver or Picatinny base.



HD501R

The product is ideal for close-range, fast-moving targets. It can improve target acquisition, boost accuracy and increase control over the shooting environment. It is built to last, with a rugged aluminum hood assembly and knobbed, tool-free mounting bolt. It is compatible with 1-inch Picatinny or Weaver rails.



HD502R

The product is ideal for close-range, fast-moving targets. It can improve target acquisition, boost accuracy and increase control over the shooting environment. It is built to last, with a rugged aluminum hood assembly and knobbed, tool-free mounting bolt. It is compatible with 1-inch Picatinny or Weaver rails.

MODEL NO.	MAGNIFICATION	ILLUMINATION	OBJECTIVE	DOT SIZE
HD119	1X	R/G	33MM	3MOA
HD120	1X	R/G	33MM	3MOA
HD551	1X	R/G	32MM	3MOA

MODEL NO.	MAGNIFICATION	ILLUMINATION	OBJECTIVE	DOT SIZE
HD119QD	1X	R/G	33MM	3MOA
HD121	1X	R/G	33MM	3MOA
HD552	1X	R/G	32MM	3MOA





HD503 R

The product is ideal for close-range, fast-moving targets. It can improve target acquisition, boost accuracy and increase control over the shooting environment. It is built to last, with a rugged aluminum hood assembly and knobbed, tool-free mounting bolt. It is compatible with 1-inch Picatinny or Weaver rails.



HD501

The product is ideal for close-range, fast-moving targets. It can improve target acquisition, boost accuracy and increase control over the shooting environment. It is built to last, with a rugged aluminum hood assembly and knobbed, tool-free mounting bolt. It is compatible with 1-inch Picatinny or Weaver rails.



HD502

The product is ideal for close-range, fast-moving targets. It can improve target acquisition, boost accuracy and increase control over the shooting environment. It is built to last, with a rugged aluminum hood assembly and knobbed, tool-free mounting bolt. It is compatible with 1-inch Picatinny or Weaver rails.



HD503

The product is ideal for close-range, fast-moving targets. It can improve target acquisition, boost accuracy and increase control over the shooting environment. It is built to last, with a rugged aluminum hood assembly and knobbed, tool-free mounting bolt. It is compatible with 1-inch Picatinny or Weaver rails.



HD502G

The product is ideal for close-range, fast-moving targets. It can improve target acquisition, boost accuracy and increase control over the shooting environment. It is built to last, with a rugged aluminum hood assembly and knobbed, tool-free mounting bolt. It is compatible with 1-inch Picatinny or Weaver rails. The green laser is also available for use. Multi rail feature makes it easy to install multiple accessories.



HD503G

The product is ideal for close-range, fast-moving targets. It can improve target acquisition, boost accuracy and increase control over the shooting environment. It is built to last, with a rugged aluminum hood assembly and knobbed, tool-free mounting bolt. It is compatible with 1-inch Picatinny or Weaver rails. The green laser is also available for use. Multi rail feature makes it easy to install multiple accessories.

MODEL NO.	MAGNIFICATION	ILLUMINATION	OBJECTIVE	DOT SIZE
HD503R	1X	R/G	32MM	3MOA
HD502	1X	R/G	32MM	3MOA
HD502G	1X	R/G	32MM	3MOA

MODEL NO.	MAGNIFICATION	ILLUMINATION	OBJECTIVE	DOT SIZE
HD501	1X	R/G	32MM	3MOA
HD503	1X	R/G	32MM	3MOA
HD503G	1X	R/G	32MM	3MOA





HD113

Offering the user 4 tactical reticle options, the shooter can switch between them without tools, and while the optic is mounted. Extended polishing process is for crisp edge to edge clarity and maximum light transmission. Multi rail feature makes it easy to install multiple accessories. The lightweight construction and unlimited eye relief permits the effective use of this optic on virtually any platform equipped with a Weaver or Picatinny base.



HD502S

The product is ideal for close-range, fast-moving targets. It can improve target acquisition, boost accuracy and increase control over the shooting environment. It is built to last, with a rugged aluminum hood assembly and knobbed, tool-free mounting bolt. It is compatible with 1-inch Picatinny or Weaver rails.



HD501S

The product is ideal for close-range, fast-moving targets. It can improve target acquisition, boost accuracy and increase control over the shooting environment. It is built to last, with a rugged aluminum hood assembly and knobbed, tool-free mounting bolt. It is compatible with 1-inch Picatinny or Weaver rails.



HD503S

The product is ideal for close-range, fast-moving targets. It can improve target acquisition, boost accuracy and increase control over the shooting environment. It is built to last, with a rugged aluminum hood assembly and knobbed, tool-free mounting bolt. It is compatible with 1-inch Picatinny or Weaver rails.



HD503KR

The product is ideal for close-range, fast-moving targets. It can improve target acquisition, boost accuracy and increase control over the shooting environment. It is built to last, with a rugged aluminum hood assembly and knobbed, tool-free mounting bolt. It is compatible with 1-inch Picatinny or Weaver rails. The red laser is also available for use. Multi rail feature makes it easy to install multiple accessories.



HD1077

Fixed focus is best for use on pistols, ARs and hunting rifles. The on/off button makes it easier to control the illumination intensity. The lightweight construction and unlimited eye relief permits the effective use of this optic on virtually any platform equipped with a Weaver or Picatinny base.

MODEL NO.	MAGNIFICATION	ILLUMINATION	OBJECTIVE	DOT SIZE
HD113	1X	R/G	33MM	3MOA
HD502S	1X	R/G	32MM	3MOA
HD503KR	1X	G	32MM	3MOA

MODEL NO.	MAGNIFICATION	ILLUMINATION	OBJECTIVE	DOT SIZE
HD501S	1X	R/G	32MM	3MOA
HD503S	1X	R/G	32MM	3MOA
HD1077	1X	R	24MM	1MOA





HD558

The product is ideal for close-range, fast-moving targets. It can improve target acquisition, boost accuracy and increase control over the shooting environment. It is built to last, with a rugged aluminum hood assembly and knobbed, tool-free mounting bolt. It is compatible with 1-inch Picatinny or Weaver rails. The anti-lost wire is available for battery compartment.



HD551

The product is ideal for close-range, fast-moving targets. It can improve target acquisition, boost accuracy and increase control over the shooting environment. It is built to last, with a rugged aluminum hood assembly and knobbed, tool-free mounting bolt. It is compatible with 1-inch Picatinny or Weaver rails.



HD552

The product is ideal for close-range, fast-moving targets. It can improve target acquisition, boost accuracy and increase control over the shooting environment. It is built to last, with a rugged aluminum hood assembly and knobbed, tool-free mounting bolt. It is compatible with 1-inch Picatinny or Weaver rails.



HD101B

Offering the user 4 tactical reticle options, the shooter can switch between them without tools, and while the optic is mounted. The red laser is also available for use. The lightweight construction and unlimited eye relief permits the effective use of this optic on virtually any platform equipped with a Weaver or Picatinny base.



SL-1

Fixed focus is best for use on pistols, ARs and hunting rifles. The red illumination dot gives the user a best choice. The lightweight construction and unlimited eye relief permits the effective use of this optic on virtually any platform equipped with a Weaver or Picatinny base.



HD101AJ

Offering the user 4 tactical reticle options, the shooter can switch between them without tools, and while the optic is mounted. The special red and green illumination control buttons are both for light color change and light shut off. The easy battery inserting compartment makes it a special design.

MODEL NO.	MAGNIFICATION	ILLUMINATION	OBJECTIVE	DOT SIZE
HD558	1X	R/G	30MM	3MOA
HD552	1X	R/G	32MM	3MOA
SL-1	1X	R	32MM	3MOA

MODEL NO.	MAGNIFICATION	ILLUMINATION	OBJECTIVE	DOT SIZE
HD551	1X	R/G	32MM	3MOA
HD101B	1X	R/G	32MM	3MOA
HD101AJ	1X	R/G	30MM	3MOA





HD1012

Offering the user 4 tactical reticle options, the shooter can switch between them without tools, and while the optic is mounted. The easy battery inserting compartment makes it a special design. By deploying or folding the lens down, the shooter can easily control the optic illumination.



HD1072

Fixed focus is best for use on pistols, ARs and hunting rifles. By deploying or folding the lens down, the shooter can easily control the optic illumination. The lightweight construction and unlimited eye relief permits the effective use of this optic on virtually any platform equipped with a Weaver or Picatinny base.



HD1078

Fixed focus is best for use on pistols, ARs and hunting rifles. The on/off buttons in the back make it easier to control the illumination intensity. The lightweight construction and unlimited eye relief permits the effective use of this optic on virtually any platform equipped with a Weaver or Picatinny base.



HD1079

Fixed focus is best for use on pistols, ARs and hunting rifles. The on/off button makes it easier to control the illumination intensity. The lightweight construction and unlimited eye relief permits the effective use of this optic on virtually any platform equipped with a Weaver or Picatinny base.

MODEL NO.	MAGNIFICATION	ILLUMINATION	OBJECTIVE	DOT SIZE
HD1012	1X	R	32MM	3MOA
HD1078	1X	R	24MM	1MOA

MODEL NO.	MAGNIFICATION	ILLUMINATION	OBJECTIVE	DOT SIZE
HD1072	1X	R	32MM	3MOA
HD1079	1X	R	24MM	1MOA





ZB3-1



ZB3-2



ZB3-3



3X MAGNIFIER SCOPE

The optic 3X30mm magnifier provides user with more clear and accurate sight. That will be helpful for shooting to increase field performances. If you need to use the open sights, the magnifier is quick and easy to flip to the side so that user can get a better look at the target. Adjusting is quite easy and simple. And the lens covers are removable. Also it's simple to screw the mount to install or unlock magnifier scope on the rail.

FOG RESISTANT



WATER RESISTANT



IMPACT RESISTANT





The red dot sight is equipped with a Dual-Illuminated multi-reticle sight with adjustable rheostat. Integrated Picatinny works well with your rifles. Windage and elevation turrets are easily accessible under protective caps. Flip-up lens protects are included to protect your lens when not in use.





HD22M1AJ

Designed with an integral weaver or picatinny base, the micro dot offers all the advantages of a reflex sight in an extra compact package. The special red and green illumination control buttons are both for light color change and light shut off. Perfect for both long guns and handguns, an easily accessible side mounted rheostat makes brightness adjustment.



HD22M1

Designed with an integral weaver or picatinny base, the micro dot offers all the advantages of a reflex sight in an extra compact package. Perfect for both long guns and handguns, an easily accessible side mounted rheostat makes brightness adjustment.



HD22H1

Easily accessible side mounted rheostat makes quick brightness adjustment possible while shooting on the move. Offering the user 4 tactical reticle options, the shooter can switch between them without tools, and while the optic is mounted.



HD22B

Designed with an integral weaver or picatinny base, the micro dot offers all the advantages of a reflex sight in an extra compact package. Equipped with a red laser provides you more use. Perfect for both long guns and handguns, an easily accessible side mounted rheostat makes brightness adjustment.



HD30D6

Designed with an integral weaver or picatinny base, the micro dot offers all the advantages of a reflex sight in an extra compact package. Equipped with a green laser provides you more use. The extended low profile tactical mount system is perfect on any rifle or handgun.



HD22C

Designed with an integral weaver or picatinny base, the micro dot offers all the advantages of a reflex sight in an extra compact package. Perfect for both long guns and handguns, an easily accessible side mounted rheostat makes brightness adjustment.

MODEL NO.	MAGNIFICATION	ILLUMINATION	OBJECTIVE	DOT SIZE
HD22M1AJ	1X	R/G	20MM	4-5MOA
HD22H1	1X	R/G	20MM	4-5MOA
HD30D6	1X	R/G	28MM	4-5MOA

MODEL NO.	MAGNIFICATION	ILLUMINATION	OBJECTIVE	DOT SIZE
HD22M1	1X	R/G	20MM	4-5MOA
HD22B	1X	R/G	20MM	4-5MOA
HD22C	1X	R/G	28MM	4-5MOA





HD22D

Designed with an integral weaver or picatinny base, the micro dot offers all the advantages of a reflex sight in an extra compact package. Perfect for both long guns and handguns, an easily accessible side mounted rheostat makes brightness adjustment.



HD25D

Designed with an integral weaver or picatinny base, the micro dot offers all the advantages of a reflex sight in an extra compact package. Shooters can take advantage of its quick-detach mount for easy removal when iron sights or other accessories are used.



HD22E

Designed with an integral weaver or picatinny base, the micro dot offers all the advantages of a reflex sight in an extra compact package. Equipped with 4 tactical reticle options, the shooter can switch between them without tools, while the optic is mounted. Perfect for both long guns and handguns, an easily accessible side mounted rheostat makes brightness adjustment.



HD25C

Designed with an integral weaver or picatinny base, the micro dot offers all the advantages of a reflex sight in an extra compact package. Shooters can take advantage of its quick-detach mount for easy removal when iron sights or other accessories are used.



HD22H

Easily accessible top mounted rheostat makes quick brightness adjustment possible while shooting on the move. Offering the user 4 tactical reticle options, the shooter can switch between them without tools, and while the optic is mounted.



HD25

This long tube enclosed red dot makes you get the target acquisition fast. Easily accessible top mounted rheostat makes quick brightness adjustment possible while shooting on the move. The lightweight construction and unlimited eye relief permits the effective use of this optic on virtually any platform equipped with a Weaver or Picatinny base.

MODEL NO.	MAGNIFICATION	ILLUMINATION	OBJECTIVE	DOT SIZE
HD22D	1X	R/G	20MM	4-5MOA
HD22E	1X	R/G	20MM	4-5MOA
HD22H	1X	R/G	20MM	4-5MOA

MODEL NO.	MAGNIFICATION	ILLUMINATION	OBJECTIVE	DOT SIZE
HD25D	1X	R/G	23MM	4-5MOA
HD25C	1X	R/G	23MM	4-5MOA
HD25	1X	R/G	23MM	4-5MOA





HD25A

This long tube enclosed red dot makes you get the target acquisition fast. Easily accessible top mounted rheostat makes quick brightness adjustment possible while shooting on the move. The lightweight construction and unlimited eye relief permits the effective use of this optic on virtually any platform equipped with a Weaver or Picatinny base.



HD30B

Easily accessible top mounted rheostat makes quick brightness adjustment possible while shooting on the move. Multi rail feature makes it easy to install multiple accessories. Exposed windage and elevation adjustment knobs make it convenient to focus the object.



HD30

Easily accessible top mounted rheostat makes quick brightness adjustment possible while shooting on the move. The lightweight construction and unlimited eye relief permits the effective use of this optic on virtually any platform equipped with a Weaver or Picatinny base.



HD30D3

It is a tactical sight loaded with flip-up covers, extended rings, turret straps- a complete package designed for all AR applications. Equipped with a red laser provides you more use. The lightweight construction and unlimited eye relief permits the effective use of this optic on virtually any platform equipped with a Weaver or Picatinny base.



HD30A

Easily accessible top mounted rheostat makes quick brightness adjustment possible while shooting on the move. The lightweight construction and unlimited eye relief permits the effective use of this optic on virtually any platform equipped with a Weaver or Picatinny base.



HD30D7

The red and green buttons beside the battery cap give it a unique design. It features a fiber optic front back up sight and removeable rear iron sight. The lightweight construction and unlimited eye relief permits the effective use of this optic on virtually any platform equipped with a Weaver or Picatinny base.

MODEL NO.	MAGNIFICATION	ILLUMINATION	OBJECTIVE	DOT SIZE
HD25A	1X	R/G	23MM	4-5MOA
HD30	1X	R/G	30MM	4-5MOA
HD30A	1X	R	30MM	4-5MOA

MODEL NO.	MAGNIFICATION	ILLUMINATION	OBJECTIVE	DOT SIZE
HD30B	1X	R/G	30MM	4-5MOA
HD30D3	1X	R/G	28MM	4-5MOA
HD30D7	1X	R/G	28MM	4-5MOA





HD30 SBD

Easily accessible top mounted rheostat makes quick brightness adjustment possible while shooting on the move. Offering the user 4 tactical reticle options, the shooter can switch between them without tools, and while the optic is mounted.



HD30EM4

Easily accessible side mounted rheostat makes quick brightness adjustment possible while shooting on the move. The lightweight construction and unlimited eye relief permits the effective use of this optic on virtually any platform equipped with a Weaver or Picatinny base.



HD30F

Equipped with an integrated slant cut shade helps reduce glare. A simple thumbscrew base makes the system equally user friendly with veteran shooters or casual hobbyists.

MODEL NO.	MAGNIFICATION	ILLUMINATION	OBJECTIVE	DOT SIZE
HD30 SBD	1X	R/G	30MM	4-5MOA
HD30EM4	1X	R/G	30MM	4-5MOA
HD30F	1X	R/G	28MM	4-5MOA



HD30GX

Powered by fiber source, providing more bright environment and reticle illumination at day. Equipped with an integrated slant cut shade helps reduce glare. A simple thumbscrew base makes the system equally user friendly with veteran shooters or casual hobbyists.



HD30H

Multi rail feature makes it easy to install multiple accessories. The level gives a function to mount the red dot to the rail steadily. The lightweight construction and unlimited eye relief permits the effective use of this optic on virtually any platform equipped with a Weaver or Picatinny base.



HD30M2

It is a tactical sight loaded with flip-up covers, extended rings, turret straps- a complete package designed for all AR applications. The lightweight construction and unlimited eye relief permits the effective use of this optic on virtually any platform equipped with a Weaver or Picatinny base.

MODEL NO.	MAGNIFICATION	ILLUMINATION	OBJECTIVE	DOT SIZE
HD30GX	1X	R	28MM	4-5MOA
HD30H	1X	R/G	28MM	4-5MOA
HD30M2	1X	R/G	28MM	4-5MOA





HD30M3

It is a tactical sight loaded with flip-up covers, extended rings, turret straps- a complete package designed for all AR applications. The lightweight construction and unlimited eye relief permits the effective use of this optic on virtually any platform equipped with a Weaver or Picatinny base.



HD30TB

Easily accessible top mounted rheostat makes quick brightness adjustment possible while shooting on the move. Multi rail feature makes it easy to install multiple accessories. Exposed windage and elevation adjustment knobs make it convenient to focus the object. Its specific design lies in the rotated cap.



HD30N

Easily accessible top mounted rheostat makes quick brightness adjustment possible while shooting on the move. This product has two kinds of wide and narrow rail for your option. The lightweight construction and unlimited eye relief permits the effective use of this optic on virtually any platform equipped with a Weaver or Picatinny base.



HD30X

Easily accessible top mounted rheostat makes quick brightness adjustment possible while shooting on the move. The lightweight construction and unlimited eye relief permits the effective use of this optic on virtually any platform equipped with a Weaver or Picatinny base.



HD30N 2X

Easily accessible top mounted rheostat makes quick brightness adjustment possible while shooting on the move. The 2x magnification feature makes you see the target clearly. The exposed windage and elevation adjustment knobs help the user adjust the dot direction move easily.



HD30X R

Easily accessible top mounted rheostat makes quick brightness adjustment possible while shooting on the move. The lightweight construction and unlimited eye relief permits the effective use of this optic on virtually any platform equipped with a Weaver or Picatinny base.

MODEL NO.	MAGNIFICATION	ILLUMINATION	OBJECTIVE	DOT SIZE
HD30M3	1X	R/G	28MM	4-5MOA
HD30N	1X	R/G	30MM	4-5MOA
HD30N 2X	2X	R/G	30MM	4-5MOA

MODEL NO.	MAGNIFICATION	ILLUMINATION	OBJECTIVE	DOT SIZE
HD30TB	1X	R/G	30MM	4-5MOA
HD30X	1X	R/G	30MM	4-5MOA
HD30X R	1X	R	30MM	4-5MOA





HD34

Equipped with an integrated slant cut shade helps reduce glare. A simple thumbscrew base makes the system equally user friendly with veteran shooters or casual hobbyists.



HD35

Easily accessible top mounted rheostat makes quick brightness adjustment possible while shooting on the move. Exposed windage and elevation adjustment knobs make it convenient to focus the object.



HD35 SBD

Easily accessible top mounted rheostat makes quick brightness adjustment possible while shooting on the move. Offering the user 4 tactical reticle options, the shooter can switch between them without tools, and while the optic is mounted. Exposed windage and elevation adjustment knobs make it convenient to focus the object.

MODEL NO.	MAGNIFICATION	ILLUMINATION	OBJECTIVE	DOT SIZE
HD34	1X	R/G	33MM	4-5MOA
HD35	1X	R/G	35MM	4-5MOA
HD35 SBD	1X	R/G	35MM	4-5MOA



HD40

Easily accessible top mounted rheostat makes quick brightness adjustment possible while shooting on the move. The lightweight construction and unlimited eye relief permits the effective use of this optic on virtually any platform equipped with a Weaver or Picatinny base.



HD40XR

Easily accessible top mounted rheostat makes quick brightness adjustment possible while shooting on the move. The lightweight construction and unlimited eye relief permits the effective use of this optic on virtually any platform equipped with a Weaver or Picatinny base.



HD22M1K

Designed with an integral weaver or picatinny base, the micro dot offers all the advantages of a reflex sight in an extra compact package. Perfect for both long guns and handguns, an easily accessible side mounted rheostat makes brightness adjustment. The hollow high riser mount decreases the weight of the product.

MODEL NO.	MAGNIFICATION	ILLUMINATION	OBJECTIVE	DOT SIZE
HD40	1X	R/G	40MM	4-5MOA
HD40XR	1X	R	40MM	4-5MOA
HD22M1K	1X	R	20MM	4-5MOA





HD22M1 QD

Designed with an integral weaver or picatinny base, the micro dot offers all the advantages of a reflex sight in an extra compact package. Shooters can take advantage of its quick-detach mount for easy removal when iron sights or other accessories are used. Perfect for both long guns and handguns, an easily accessible side mounted rheostat makes brightness adjustment.



HD22M1 YG

Designed with an integral weaver or picatinny base, the micro dot offers all the advantages of a reflex sight in an extra compact package. Perfect for both long guns and handguns, an easily accessible side mounted rheostat makes brightness adjustment.



HD22M1 G

Designed with an integral weaver or picatinny base, the micro dot offers all the advantages of a reflex sight in an extra compact package. The high riser mount is perfect for adding correct height for options on your AR-15 or tactical rifle. Perfect for both long guns and handguns, an easily accessible side mounted rheostat makes brightness adjustment.

MODEL NO.	MAGNIFICATION	ILLUMINATION	OBJECTIVE	DOT SIZE
HD22M1 QD	1X	R/G	20MM	4-5MOA
HD22M1 YG	1X	R/G	20MM	4-5MOA
HD22M1 G	1X	R/G	20MM	4-5MOA



HD30M2 SBD

It is a tactical sight loaded with flip-up covers, extended rings, turret straps- a complete package designed for all AR applications. Offering the user 4 tactical reticle options, the shooter can switch between them without tools, and while the optic is mounted. The lightweight construction and unlimited eye relief permits the effective use of this optic on virtually any platform equipped with a Weaver or Picatinny base.



HD30M3 YG

It is a tactical sight loaded with flip-up covers, extended rings, turret straps- a complete package designed for all AR applications. The lightweight construction and unlimited eye relief permits the effective use of this optic on virtually any platform equipped with a Weaver or Picatinny base.



HD30R

The red and green buttons on the top make it an unique design different from other models. The red laser equipped gives it another use for choose. Perfect for both long guns and handguns, an easily accessible side mounted rheostat makes brightness adjustment.

MODEL NO.	MAGNIFICATION	ILLUMINATION	OBJECTIVE	DOT SIZE
HD30M2 SBD	1X	R/G	28MM	4-5MOA
HD30M3 YG	1X	R/G	28MM	4-5MOA
HD30R	1X	R/G	30MM	4-5MOA





HD30M3 R

It is a tactical sight loaded with flip-up covers, extended rings, turret straps- a complete package designed for all AR applications. The lightweight construction and unlimited eye relief permits the effective use of this optic on virtually any platform equipped with a Weaver or Picatinny base.



HD30M3 B

It is a tactical sight loaded with flip-up covers, extended rings, turret straps- a complete package designed for all AR applications. The lightweight construction and unlimited eye relief permits the effective use of this optic on virtually any platform equipped with a Weaver or Picatinny base.



HD22X

Designed with an integral weaver or picatinny base, the micro dot offers all the advantages of a reflex sight in an extra compact package. Perfect for both long guns and handguns, an easily accessible side mounted rheostat makes brightness adjustment.



HDM1AL

Designed with a high riser mount or low mount, this micro dot offers all the advantages of a reflex sight in an extra compact package. The special red and green illumination control buttons are both for light color change and light shut off. It is perfect for both long guns and handguns. The see-through high riser makes it easy and simple to keep your eyes on things in front of you.



HDM1KS

Designed with an integral weaver or picatinny base, the micro dot offers all the advantages of a reflex sight in an extra compact package. The special red and green illumination control buttons are both for light color change and light shut off. It is perfect for both long guns and handguns.



H-MRO

The large viewing area allows faster target acquisition and engagement with reduced tube effect. There is a mid-position OFF feature for brightness settings. It is perfect for both long guns and handguns.

MODEL NO.	MAGNIFICATION	ILLUMINATION	OBJECTIVE	DOT SIZE
HD30M3 R	1X	R/G	28MM	4-5MOA
HD22X	1X	R/G	20MM	4-5MOA
HDM1KS	1X	R/G	20MM	4-5MOA

MODEL NO.	MAGNIFICATION	ILLUMINATION	OBJECTIVE	DOT SIZE
HD30M3 B	1X	R/G	28MM	4-5MOA
HDM1AL	1X	R/G	28MM	4-5MOA
H-MRO	1X	R	30MM	4-5MOA





HDM1AK

Designed with an integral weaver or picatinny base, the micro do offers all the advantages of a reflex sight in an extra compact package. The special red and green illumination control buttons are both for light color change and light shut off. The easy battery inserting compartment makes it a special design. The see-through high riser makes it easy and simple to keep your eyes on things in front of you.



HD-FC1

The on/off buttons in the back make it easier to control the illumination intensity. The lightweight construction and unlimited eye relief permits the effective use of this optic on virtually any platform equipped with a Weaver or Picatinny base. The easy battery inserting compartment makes it a special design.



HD30L

Designed with an high riser mount or low mount, this micro dot offers all the advantages of a reflex sight in an extra compact package. The special red and green illumination control buttons are both for light color change and light shut off. Equipped with a red or green laser gives this sight another kind of function.

MODEL NO.	MAGNIFICATION	ILLUMINATION	OBJECTIVE	DOT SIZE
HDM1AK	1X	R/G	20MM	4-5MOA
HD30L	1X	R/G	32MM	3MOA

MODEL NO.	MAGNIFICATION	ILLUMINATION	OBJECTIVE	DOT SIZE
HD-FC1	1X	R	20MM	4-5MOA





The tactical red or green laser provides clear and strong pointing dot no matter in sunny daylight or in the dark with low light. There is adjustable pointing for up/down and right/left by hand. Coming with a remote control, it is easy to switch laser on and off. Additional mount provided can hold the laser and fit on any 20mm width weaver rail base. It is perfect for novice shooters as well as professionals. Our laser scope is a must-have for anyone with a shotgun and can be used regardless of plinking or shooting competitively.





JG1

This tactical laser can be mounted to your rifle or pistol when you need quick target acquisition. It includes ring mount and pressure switch extension. It is fully adjustable for windage and elevation.



JG1-1

This tactical laser can be mounted to your rifle or pistol when you need quick target acquisition. It includes ring mount and pressure switch extension. It is fully adjustable for windage and elevation.



JG1-2

This tactical laser can be mounted to your rifle or pistol when you need quick target acquisition. It includes ring mount and pressure switch extension. It is fully adjustable for windage and elevation.



JG1-3

This tactical laser can be mounted to your rifle or pistol when you need quick target acquisition. It includes ring mount and pressure switch extension. It is fully adjustable for windage and elevation.



JG1-4

This tactical laser can be mounted to your rifle or pistol when you need quick target acquisition. It includes ring mount and pressure switch extension. It is fully adjustable for windage and elevation.



JG1-5

This tactical laser can be mounted to your rifle or pistol when you need quick target acquisition. It includes ring mount and pressure switch extension. It is fully adjustable for windage and elevation.

MODEL NO.	LASER TYPE	POWER/WAVELENGTH	BATTERY
JG1	RED/GREEN	<5MW/625-660NM(RED) <5MW/532NM(GREEN)	CR123A
JG1-2	RED/GREEN	<5MW/625-660NM(RED) <5MW/532NM(GREEN)	CR123A
JG1-4	RED/GREEN	<5MW/625-660NM(RED) <5MW/532NM(GREEN)	CR123A

MODEL NO.	LASER TYPE	POWER/WAVELENGTH	BATTERY
JG1-1	RED/GREEN	<5MW/625-660NM(RED) <5MW/532NM(GREEN)	CR123A
JG1-3	RED/GREEN	<5MW/625-660NM(RED) <5MW/532NM(GREEN)	CR123A
JG1-5	RED/GREEN	<5MW/625-660NM(RED) <5MW/532NM(GREEN)	CR123A





JG2

The compact design is almost fit for any weapon system. It is equally at home on a hand gun or a long gun.



JG3-1

The compact design is almost fit for any weapon system. It is equally at home on a hand gun or a long gun.



JG3-2

This tactical red laser can be mounted to virtually any rifle barrel profile. The adjustable bracket allows a wide variety of fit options and placement locations along the length of the barrel.



JG3-3

The compact design is almost fit for any weapon system. It is equally at home on a hand gun or a long gun. The extra part included is to enhance strength and durability while remaining lightweight.



JG3-4

The compact design is almost fit for any weapon system. It is equally at home on a hand gun or a long gun.



JG5-1

The compact design is almost fit for any weapon system. It is equally at home on a hand gun or a long gun.

MODEL NO.	LASER TYPE	POWER/WAVELENGTH	BATTERY
JG2	RED	<5MW/625-660NM	LR44
JG3-2	RED	<5MW/625-660NM	LR44
JG3-4	RED	<5MW/625-660NM	LR44

MODEL NO.	LASER TYPE	POWER/WAVELENGTH	BATTERY
JG3-1	RED	<5MW/625-660NM	LR44
JG3-3	RED	<5MW/625-660NM	LR44
JG5-1	RED	<5MW/625-660NM	LR44





JG5-2

The compact design is almost fit for any weapon system. It is equally at home on a hand gun or a long gun. The interchangeable mount makes it suit more weapons.



JG8

The compact design is almost fit for any weapon system. It is equally at home on a hand gun or a long gun. The interchangeable mount makes it suit more weapons.



JG8A

The compact design is almost fit for any weapon system. It is equally at home on a hand gun or a long gun. The interchangeable mount makes it suit more weapons.



JG8G

The compact design is almost fit for any weapon system. It is equally at home on a hand gun or a long gun. The interchangeable mount makes it suit more weapons.



JG9

This tactical laser can be mounted to your rifle or pistol when you need quick target acquisition. It includes ring mount and pressure switch extension. It is fully adjustable for windage and elevation.



JG10

This compact pistol laser is fully adjustable for windage and elevation. The cross bolt on and off buttons is for quick activation and deactivation.

MODEL NO.	LASER TYPE	POWER/WAVELENGTH	BATTERY
JG5-2	RED	<5MW/625-660NM	LR44
JG8A	RED	<5MW/625-660NM	LR44
JG9	RED/GREEN	<5MW/625-660NM(RED) <5MW/532NM(GREEN)	CR123A

MODEL NO.	LASER TYPE	POWER/WAVELENGTH	BATTERY
JG8	RED	<5MW/625-660NM	LR44
JG8G	GREEN	<5MW/532NM	14250
JG10	RED	<5MW/625-660NM	LR44 STACK





JG10A

This compact pistol laser is fully adjustable for windage and elevation. The cross bolt on and off buttons is for quick activation and deactivation. The narrow rail makes it suit more weapons.



JG11

The compact design is almost fit for any weapon system. It is equally at home on a hand gun or a long gun.



JG13G

This tactical laser can be mounted to your rifle or pistol when you need quick target acquisition. It includes ring mount and pressure switch extension. It is fully adjustable for windage and elevation.



JG13R

This tactical laser can be mounted to your rifle or pistol when you need quick target acquisition. It includes ring mount and pressure switch extension. It is fully adjustable for windage and elevation.



JG15

The compact design is almost fit for any weapon system. It is equally at home on a hand gun or a long gun.



JG19

The compact design is almost fit for any weapon system. It is equally at home on a hand gun or a long gun.

MODEL NO.	LASER TYPE	POWER/WAVELENGTH	BATTERY
JG10A	RED	<5MW/625-660NM	LR44 STACK
JG13G	GREEN	<5MW/532NM	CR2
JG15	RED	<5MW/625-660NM	LR1130

MODEL NO.	LASER TYPE	POWER/WAVELENGTH	BATTERY
JG11	RED	<5MW/625-660NM	LR41
JG13R	RED	<5MW/625-660NM	CR2
JG19	RED	<5MW/625-660NM	LR44





JG18

The compact design is almost fit for any weapon system. It is equally at home on a hand gun or a long gun.



SD05

This tactical flashlight is made of high quality aluminum alloy in durable black matte finish. It includes ring mount and pressure switch extension. It is fully adjustable for windage and elevation.



JG8C/G

The universal slide-on laser ring is perfect for picatinny/weaver rails. It is also with adjustable clamping feature for more laser diameters.



JG8C/R

The universal slide-on laser ring is perfect for picatinny/weaver rails. It is also with adjustable clamping feature for more laser diameters.



JG5/G

The compact design is almost fit for any weapon system. It is equally at home on a hand gun or a long gun. The interchangeable mount makes it suit more weapons.



JG5/R

The compact design is almost fit for any weapon system. It is equally at home on a hand gun or a long gun. The interchangeable mount makes it suit more weapons.

MODEL NO.	LASER TYPE	POWER/WAVELENGTH	BATTERY
JG18	RED	<5MW/625-660NM	LR44
JG8C/G	GREEN	<5MW/532NM	14250
JG5/G	GREEN	20-50MW/532NM	CR2

MODEL NO.	LASER TYPE	POWER/WAVELENGTH	BATTERY
SD05	GREEN	151MM	18650
JG8C/R	RED	<5MW/532NM	14250
JG5R	RED	20-50MW/532NM	CR2





JG16-19(RED)



JG16-19(GREEN)



JG16-19(RED)



JG16-19(GREEN)



22-250



45 COLT



30-30WIN



8MM



223REM



9MM



308





7.62/54R



7MM



7.62X39MM



303BR



20GA



50BMG



30-06/.25-06



300WIN



12G



TLZ762



16GA



TLZ7MM

ITEM	OUTPUT	BATTERY	WEIGHT
22-250	5MW	AG3	45g
45COLT	5MW	AG3	56g
30-30WIN	5MW	AG3	43g
8MM	5MW	AG3	56g
223REM	5MW	AG3	30g
9MM	5MW	AG3	34g

ITEM	OUTPUT	BATTERY	WEIGHT
308	5MW	AG3	52g
7.62x54R	5MW	AG3	30g
7MM	5MW	AG3	69g
7.62x39MM	5MW	AG3	39g
303BR	5MW	AG3	50g
20GA	5MW	AG3	112g

ITEM	OUTPUT	BATTERY	WEIGHT
50BMG	5MW	AG3	50g
30-06/.25-06/270	5MW	AG3	39g
300WIN	5MW	AG3	73g
12G	5MW	AG3	163g
TLZ762	5MW	AG3	40g
16GA	5MW	AG3	64g
TLZ7MM	5MW	AG3	57g





With the unique appearance of structural design, our ZL series quickly occupied the market. This latest style allows you to get an unprecedented quick aiming experience while hunting.

Dual red and green illumination with 5 brightness settings allows reticle visibility to be maximized in all light condition .

We vigorously test each ZL scope for both shock and moisture ingress, thus ensuring all of them will stand up to extreme conditions.





ZL4-16X44 FFP



V8 4-20X50

ZLVT SERIES

MODEL	MAGNIFICATION	ILLUMINATION	TUBE DIAMETER	OBJECTIVE	EYE RELIEF	LENS COATING	LENGTH	WEIGHT	BATTERY
ZL4-16x44FFP	4-16x	RED & GREEN	30mm	44mm	76-89mm	FMC	340mm	795g	CR2032
ZL4-20x50FFP	4-20x		30mm	50mm	76-89mm		355mm	800g	
V8 4-20X50	4-20x		30mm	50mm	85-100mm		353mm	730g	
V8 6-24X44	6-24x		30mm	44mm	85-100mm		355mm	750g	

RETICLE OPTIONS

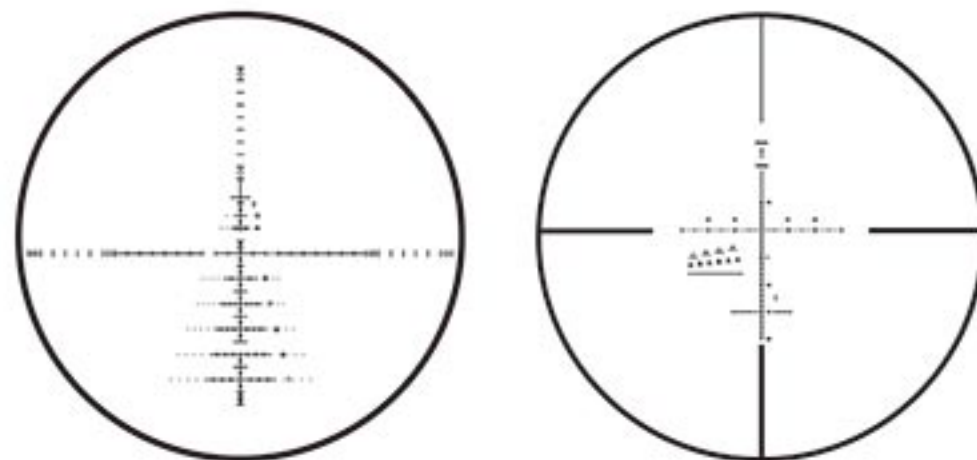

RETICLE COLORS



FOG RESISTANT



WATER RESISTANT



IMPACT RESISTANT





ZLMT SERIES



HD4.5-18X44FFP



VT4-16X44

MODEL	MAGNIFICATION	ILLUMINATION	TUBE DIAMETER	OBJECTIVE	EYE RELIEF	LENS COATING	LENGTH	WEIGHT	BATTERY
HD4.5-18X44FFP	4.5-18x	RED & GREEN	30mm	44mm	85-100mm	FMC	350mm	675g	CR2032
HD5-25X50FFP	5-25x	RED & GREEN	30mm	50mm	85-100mm		352mm	685g	CR2032
VT4-16X44	4-16x		30mm	44mm	85-100mm		343mm	625g	
VT6-24X44	6-24x		30mm	44mm	85-100mm		345mm	631g	

RETICLE OPTIONS

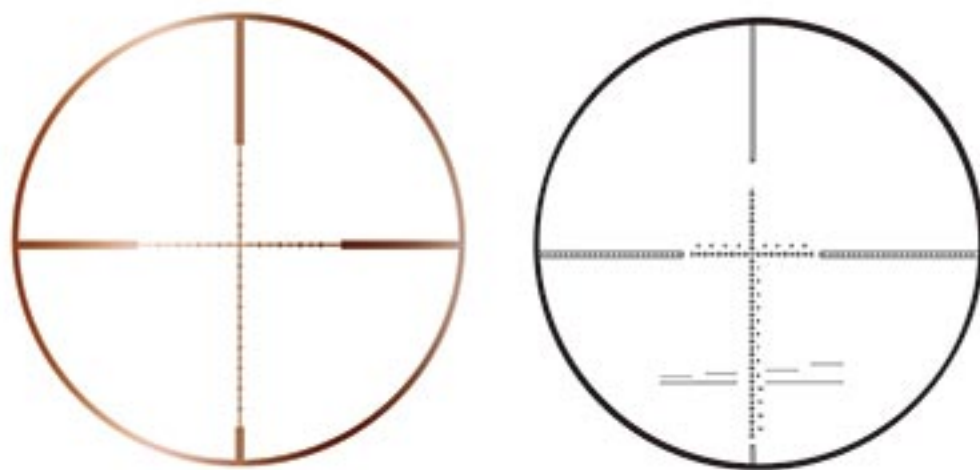

RETICLE COLORS



FOG RESISTANT



WATER RESISTANT



IMPACT RESISTANT





Our flagship riflescope makes a triumphant return to CL series featuring an all new 4x ratio optical system, designed to give shooters ultimate flexibility when transitioning between short and long range shooting. Exceptional clarity throughout the field of view together with crisp image transmission ensures an unsurpassed viewing experience.

The 30mm mono-tube chassis is machined from high-grade aluminum. Low-profile turrets provide smooth and precise adjustments. Side focus control allows for correcting parallax errors with ease and efficiency. The electronic button switch and dual (red and green) illumination have been carefully crafted with 5 step illumination controls to ensure prime reticle viewing in any light condition.

We vigorously test every CL scope for both shock and moisture ingress, ensuring each one will stand up to extreme conditions.



CL/JL SERIES



CL 5-20X50FFP



SF 4.5-18X44IR



4.5-18X50IR

TYPE	MODEL	MAGNIFICATION	ILLUMINATION	TUBE DIAMETER	OBJECTIVE	EYE RELIEF	LENS COATING	LENGTH	WEIGHT	BATTERY	
JL100	SF 4.5-18X44IR	4.5-18x	RED & GREEN & BLUE	30mm	44mm	81-95mm	FMC	350mm	650g	CR2032	
	SF 3-15X44IR	3-15x			44mm	81-95mm		360mm	670g		
	SF 4-14X50IR	4-14x			50mm	81-95mm		360mm	675g		
JL200	3-12X44IR	3-12x			44mm	81-95mm		332mm	665g		
	5-20X44IR	5-20x			50mm	81-95mm		350mm	660g		
	4.5-18X50IR	4.5-18x			44mm	81-95mm		334mm	680g		
CL	CL4-14X44SFL	4-14x			RED & GREEN	44mm		81-95mm	330mm		690g
	CL4-14X44FFP	4-14x				44mm		81-95mm	330mm		685g
	FFP4-16X50AJ	4-16x				50mm		81-95mm	335mm		740g
	FFP5-22X50AJ	5-22x	50mm	81-95mm		352mm	730g				
	CL5-20X50FFP	5-20x	50mm	81-95mm		392mm	785g				
	CL4-16X56SF	4-16x	56mm	81-95mm		330mm	775g				

RETICLE OPTIONS

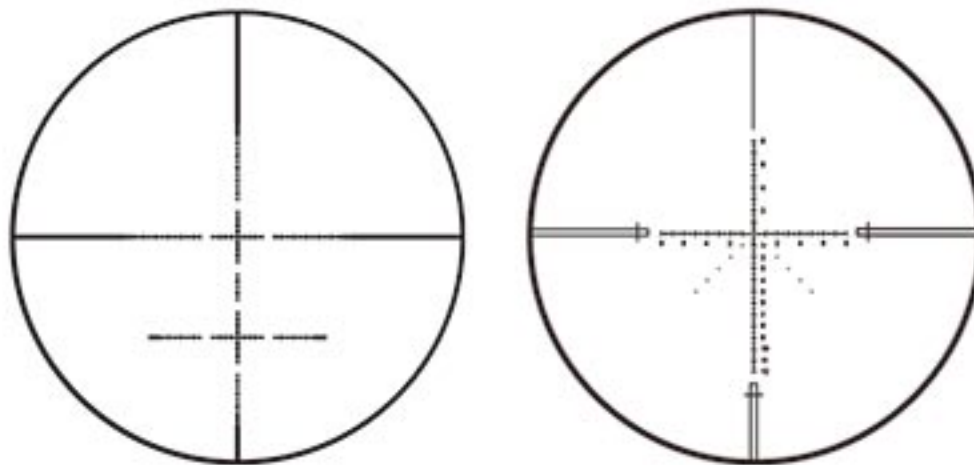

RETICLE COLORS



FOG RESISTANT



WATER RESISTANT



IMPACT RESISTANT





TMD scopes come with FFP (first focal plane) reticle are nitrogen filled, providing a wide view, which is also rain and fog proof. Illuminated or non-illuminated is optional. Equipped with side focus torque, it is positioned within easy reach whenever in close or long range shooting. Moreover, they are featured with locking turret and fully multi-coated lenses.





TMD SERIES



FFP4-14X44



FFP4-14X44IR

MODEL	MAGNIFICATION	ILLUMINATION	TUBE DIAMETER	OBJECTIVE	EYE RELIEF	LENS COATING	LENGTH	WEIGHT
FFP4-14X44	4-14x		30mm	44mm	76-89mm	GREEN	357mm	635g
FFP4-14X44IR	4-14x	RED & GREEN	30mm	44mm	76-89mm		360mm	650g

RETICLE OPTIONS

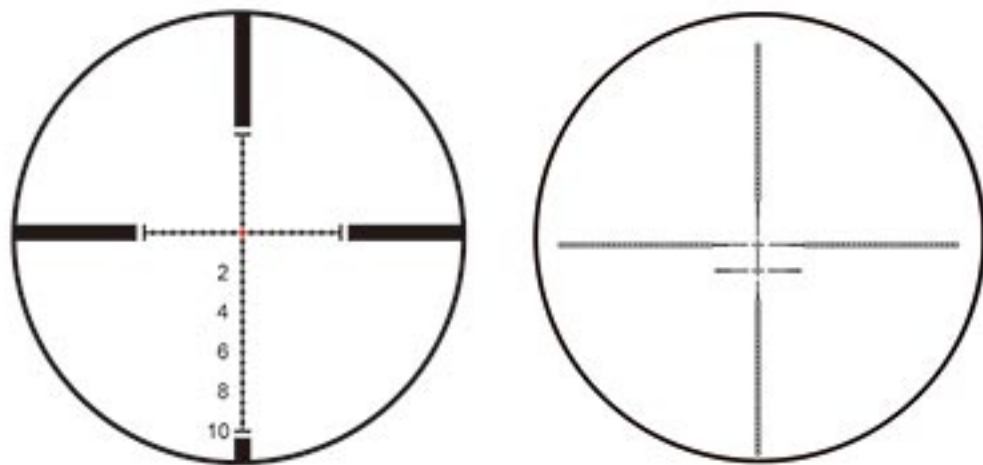

RETICLE COLORS



FOG RESISTANT

WATER RESISTANT

IMPACT RESISTANT





This modern and popular HL series are high shockproof. Scopes are nitrogen filled for superior water resistance and fog protection. All models have side focus adjustment, side illumination, fully multi-coated lenses, giving it an excellent configuration, which definitely exceeds expectations. Exceptional clarity throughout the field of view ensures an outstanding viewing experience.



ZS MC HK HL



MC-Z 4.5-18x44 FFP



MC-FFP 5-25x50 AJ

MODEL	MAGNIFICATION	ILLUMINATION	TUBE DIAMETER	OBJECTIVE	EYE RELIEF	LENS COATING	LENGTH	WEIGHT	BATTERY
MC-Z 4.5-18x44 FFP	4.5-18x	RED & GREEN	30mm	44mm	86-96mm	FMC	360mm	740g	CR2032
MC-Z 5-25x50 FFP	5-25x		30mm	50mm	86-96mm		370mm	750g	
MC-FFP 4.5-18x44 AJ	4.5-18x		30mm	44mm	86-96mm		350mm	665g	
MC-FFP 5-25x50 AJ	5-25x		30mm	50mm	86-96mm		346mm	625g	

RETICLE OPTIONS

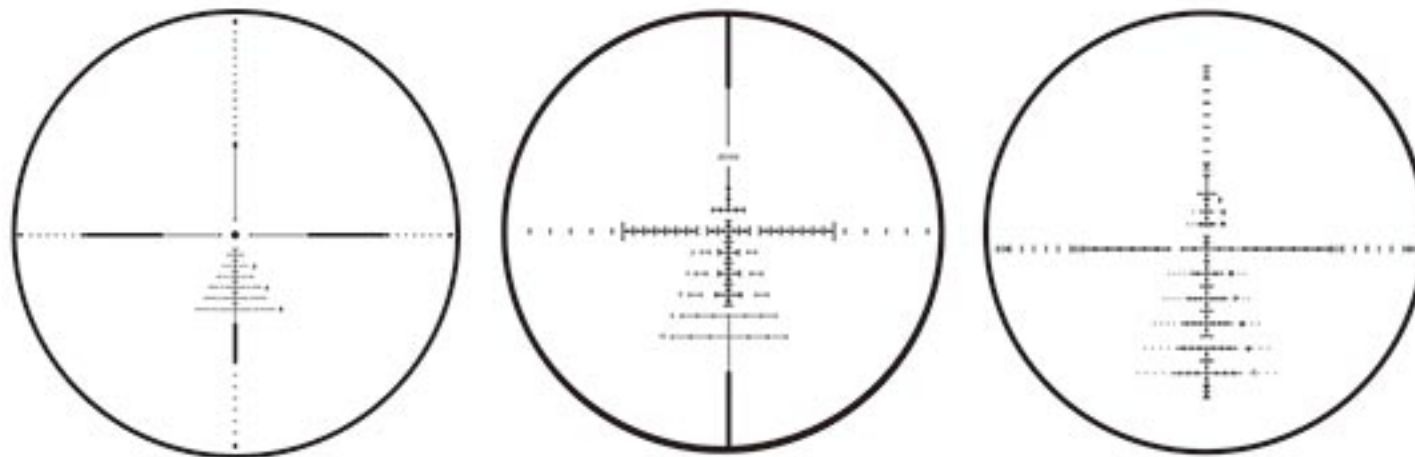

RETICLE COLORS



FOG RESISTANT



WATER RESISTANT



IMPACT RESISTANT





4-16X50AOMC

MODEL	MAGNIFICATION	ILLUMINATION	TUBE DIAMETER	OBJECTIVE	EYE RELIEF	LENS COATING	LENGTH	WEIGHT	BATTERY
3-9x40AOMC	3-9x	RED & GREEN	25.4mm	40mm	76-89mm	FMC	323mm	545g	CR2032
4-16x40AOMC	4-16x		25.4mm	40mm	76-89mm		357mm	615g	
4-16x50AOMC	4-16x		25.4mm	50mm	76-89mm		378mm	685g	
6-24x50AOMC	6-24x		25.4mm	50mm	76-89mm		410mm	720g	

ZS MC HK HL

RETICLE OPTIONS



RETICLE COLORS



FOG RESISTANT



WATER RESISTANT



IMPACT RESISTANT





1-4X24RG



FFP1-4X24E



2.5-10X40AOMC

MODEL	MAGNIFICATION	ILLUMINATION	TUBE DIAMETER	OBJECTIVE	EYE RELIEF	LENS COATING	LENGTH	WEIGHT	BATTERY
1-4x24RG	1-4x	RED & GREEN	30mm	24mm	76-89mm	FMC	250mm	395g	CR2032
2.5-10x40AOMC	2.5-10x	RED & GREEN & BLUE	25.4mm	40mm	76-89mm		398mm	740g	
4-14x40AOMC	4-14x		25.4mm	40mm	76-89mm		374mm	680g	
4-16x40AOMC	4-16x		25.4mm	40mm	76-89mm		365mm	675g	
4.5-18x44AOMC	4.5-18x		25.4mm	44mm	76-89mm		327mm	560g	
5-20x44AOMC	5-20x		25.4mm	44mm	76-89mm		358mm	600g	
4-16x50AOMC	4-16x		25.4mm	50mm	76-89mm		349mm	680g	
5-20x50AOMC	5-20x		25.4mm	50mm	76-89mm		366mm	680g	
6-24x50AOMC	6-24x		25.4mm	50mm	76-89mm		410mm	720g	
FFP1-4X24E	1-4x		30mm	24mm	81-95mm		GREEN	250mm	

RETICLE OPTIONS

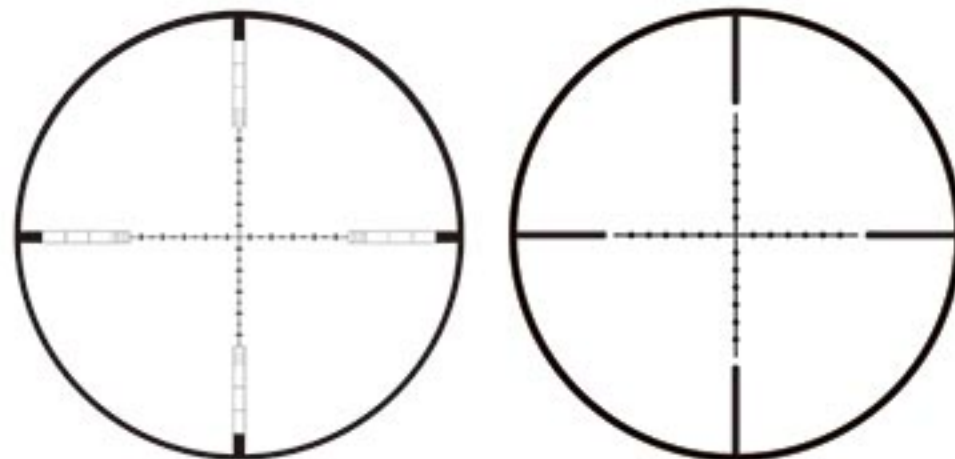

RETICLE COLORS



FOG RESISTANT



WATER RESISTANT



IMPACT RESISTANT



ZS MC HK HL



SF 8-32X56IR

MODEL	MAGNIFICATION	ILLUMINATION	TUBE DIAMETER	OBJECTIVE	EYE RELIEF	LENS COATING	LENGTH	WEIGHT	BATTERY
SF 8-32X56IR	8-32	RED & GREEN	25.4mm	56mm	76-89mm	FMC	404mm	815g	CR2032

RETICLE OPTIONS



RETICLE COLORS



FOG RESISTANT



WATER RESISTANT



IMPACT RESISTANT





5-20x50AOIR



HL4.5-18x50SF

MODEL	MAGNIFICATION	ILLUMINATION	TUBE DIAMETER	OBJECTIVE	EYE RELIEF	LENS COATING	LENGTH	WEIGHT	BATTERY
2.5-10x40AOIR	2.5-10x	RED & GREEN & BLUE	25.4mm	40mm	76-89mm	FMC	327mm	560g	CR2032
4-14x40AOIR	4-14x		25.4mm	40mm	76-89mm		358mm	600g	
4.5-18x44AOIR	4.5-18x		25.4mm	44mm	76-89mm		349mm	675g	
5-20x44AOIR	5-20x		25.4mm	44mm	76-89mm		366mm	700g	
5-20x50AOIR	5-20x		25.4mm	50mm	76-89mm		398mm	740g	
4-16x50AOIR	4-16x		25.4mm	50mm	76-89mm		374mm	680g	
HL4-14x44SF	4-14x		30mm	44mm	76-89mm		330mm	675g	
HL3-12x44SF	3-12x		30mm	44mm	76-89mm		305mm	675g	
HL4.5-18x50SF	4.5-18x		30mm	50mm	76-89mm		345mm	720g	
HL4-16x56SF	4-16x		30mm	56mm	76-89mm		330mm	760g	

RETICLE OPTIONS

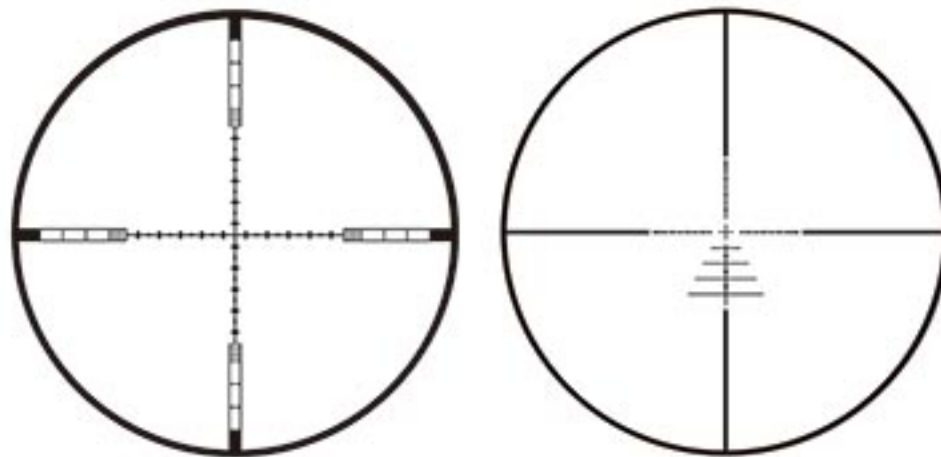

RETICLE COLORS



FOG RESISTANT



WATER RESISTANT



IMPACT RESISTANT



ZS MC HK HL



With FMC lens, the tactical riflescope can aim at targets quickly and precisely with high light transmission and resolution.

Red, green and blue illumination provides a better sense of using. With its one piece tube construction, this scope is much more durable and can bear greater strength.

With the offset cantilever dual ring mount, scopes can be installed easily and work stable. Some models allow precision adjustment with side parallax adjustments in a turret-mounted focus knob. The scopes provide crisp image for your accurate shooting.





1.5-5X40BE



STS 4-16X44SF



SF10-40X50

MODEL	MAGNIFICATION	ILLUMINATION	TUBE DIAMETER	OBJECTIVE	EYE RELIEF	LENS COATING	LENGTH	WEIGHT	BATTERY
1.5-4X30BE	1.5-4x	RED & GREEN & BLUE	30mm	30mm	76-89mm	GREEN	255mm	667g	CR2032
2-7X32BE	2-7x		30mm	32mm	76-89mm		298mm	691g	
1.5-5X40BE	1.5-5x		30mm	40mm	76-89mm		257mm	754g	
3-9X40BE	3-9x		30mm	40mm	76-89mm		310mm	810g	
3.5-10X50BE	3.5-10x		30mm	50mm	76-89mm		334mm	840g	
SF 3-12X44E IR	3-12x		30mm	44mm	81-95mm		304mm	620g	
STS 6-24X44 SF	6-24x	25.4mm	44mm	81-95mm	350mm		650g		
SF10-40X50	10-40x	RED & GREEN	30mm	50mm	81-95mm		418mm	760g	
SF4-16X56 IR	4-16x	RED & GREEN & BLUE	30mm	56mm	81-95mm		325mm	625g	
STS 4-16X44SF	4-16x	25.4mm	56mm	81-95mm	350mm		635g		

RETICLE OPTIONS

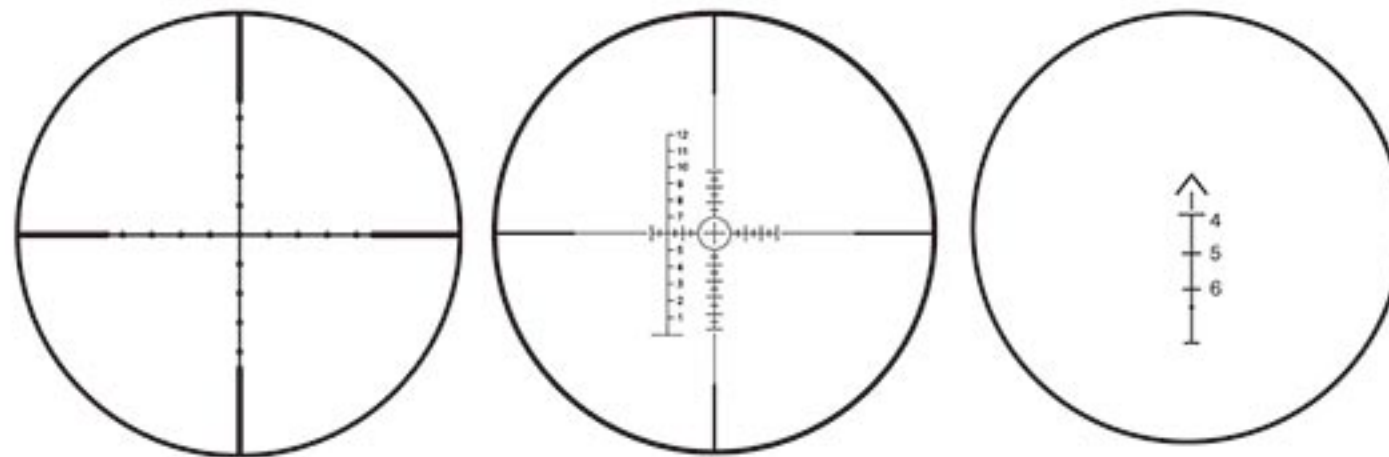

RETICLE COLORS



FOG RESISTANT

WATER RESISTANT

IMPACT RESISTANT





The typical short scopes are mid-range that offer the flexibility utilizing 2.5-10 power magnification. In addition, dual illumination reticle ensures that target acquisition is optimized for any ambient light level and environment. The body can be designed with a built-in detach base for fast installation and removal. Furthermore, mini red dot sights or lasers are available equipped onto the scopes per your needs.



Short Scope with Laser



2.5-10X40 E/R

Ideal for short to medium range, and equipped with a side mounted red laser, shooters have the bases covered with this unit. Designed with a bullet drop compensator, elevation adjustment at different ranges is made easy. A cut sunshade is integral with the objective bell, and the simple thumb screw base makes the system equally user friendly with veteran shooters or casual hobbyists.



2.5-10X40 E/G

Ideal for short to medium range, and equipped with a side mounted green laser, shooters have the bases covered with this unit. Designed with a bullet drop compensator, elevation adjustment at different ranges is made easy. A cut sunshade is integral with the objective bell, and the simple thumb screw base makes the system equally user friendly with veteran shooters or casual hobbyists.



2.5-10X40

This scope is ideal for short to medium range shooting. Designed with a bullet drop compensator, elevation adjustment at different ranges is made easy. A cut sunshade is integral with the objective bell, and the simple thumb screw base makes the system equally user friendly with veteran shooters or casual hobbyists.



2.5-10X40 B/G

Ideal for short to medium range, and equipped with a side mounted green laser, shooters have the bases covered with this unit. Designed with a bullet drop compensator, elevation adjustment at different ranges is made easy. A cut sunshade is integral with the objective bell. Utilizing a quick release mount is textured for easy operation under any conditions.



3-9X42E P4

This scope is ideal for short to medium range shooting. Designed with a bullet drop compensator, elevation adjustment at different ranges is made easy. A cut sunshade is integral with the objective bell. Utilizing a quick release mount is textured for easy operation under any conditions.



3-9X42E+HD107

This scope is ideal for short to medium range shooting. Designed with a bullet drop compensator, elevation adjustment at different ranges is made easy. A cut sunshade is integral with the objective bell. Utilizing a quick release mount is textured for easy operation under any conditions.

MODEL	MAGNIFICATION	ILLUMINATION	OBJECTIVE	LENS COATING	LENGTH	WEIGHT
2.5-10X40E/R	2.5-10x	RED & GREEN	40mm	FMC	198mm	532g
2.5-10X40E/G	2.5-10x	RED & GREEN	40mm	FMC	198mm	563g
2.5-10X40	2.5-10x		40mm	FMC	198mm	510g
2.5-10X40B/G	2.5-10x	RED & GREEN	40mm	FMC	198mm	568g
3-9X42E P4	3-9x	RED & GREEN	42mm	FMC	198mm	510g
3-9X42E +HD107	3-9x	RED & GREEN	42mm	FMC	198mm	540g





3-9X40QD

This scope is ideal for short to medium range shooting. Designed with a bullet drop compensator, elevation adjustment at different ranges is made easy. A cut sunshade is integral with the objective bell, and the simple thumb screw base makes the system equally user friendly with veteran shooters or casual hobbyists. Utilizing a quick release mount is textured for easy operation under any conditions.



4X25 M6

Ideal for short to medium range, and equipped with a side mounted red laser, shooters have the bases covered with this unit. Easily accessible top mounted rheostat makes quick brightness adjustment possible while shooting on the move. The interchangeable mount makes it suit more weapons.



4X30 M7

Ideal for short to medium range, and equipped with a side mounted red laser, shooters have the bases covered with this unit. Easily accessible top mounted rheostat makes quick brightness adjustment possible while shooting on the move. The interchangeable mount makes it suit more weapons. A cut sunshade is integral with the objective bell.



3.5-10X40E M8

Ideal for short to medium range, and equipped with a side mounted red laser, shooters have the bases covered with this unit. Easily accessible top mounted rheostat makes quick brightness adjustment possible while shooting on the move. The interchangeable mount makes it suit more weapons. A cut sunshade is integral with the objective bell.



LS3.5-10X40AOEG

Ideal for short to medium range, and equipped with a side mounted red laser, shooters have the bases covered with this unit. Easily accessible top mounted rheostat makes quick brightness adjustment possible while shooting on the move. The interchangeable mount makes it suit more weapons. The addition of a front parallax ring enables greater precision at longer ranges.



3-10X42E M9

Ideal for short to medium range, and equipped with a side mounted red laser, shooters have the bases covered with this unit. Easily accessible top mounted rheostat makes quick brightness adjustment possible while shooting on the move. The interchangeable mount makes it suit more weapons. A cut sunshade is integral with the objective bell. Multi rail feature makes it easy to install multiple accessories.

Short Scope with Laser

MODEL	MAGNIFICATION	ILLUMINATION	OBJECTIVE	LENS COATING	LENGTH	WEIGHT
3-9X40QD	3-9x	RED & GREEN	40mm	FMC	205mm	477g
4X25 M6	4x	RED & GREEN	25mm	FMC	168mm	424g
4X30 M7	4x	RED & GREEN	30mm	FMC	193mm	458g
3.5-10X40E M8	3.5-10x	RED & GREEN	40mm	FMC	260mm	600g
LS3.5-10X40AOEG	3.5-10x	RED & GREEN	40mm	FMC	280mm	640g
3-10X42E M9	3-10x	RED & GREEN	42mm	FMC	210mm	441g





3-9X40V

This ultra-compact scope is ideal for medium range shooting. This very small profile makes the shooter easily to mount the unit on nearly any type of rifles with equal utility.



3-9X40VE

This ultra-compact scope is ideal for medium range shooting. This very small profile makes the shooter easily to mount the unit on nearly any type of rifles with equal utility.



3-9X42E

This ultra-compact scope is ideal for medium range shooting. This very small profile makes the shooter easily to mount the unit on nearly any type of rifles with equal utility. The exposed windage and elevation knobs make the adjustment more convenient.



FFP 3-12X32AO

This ultra-compact scope is ideal for medium range shooting. This very small profile makes the shooter easily to mount the unit on nearly any type of rifles with equal utility. The exposed windage and elevation knobs make the adjustment more convenient.

MODEL	MAGNIFICATION	ILLUMINATION	OBJECTIVE	LENS COATING	LENGTH	WEIGHT
3-9X40V	3-9x		40mm	FMC	205mm	374g
3-9X40VE	3-9x	RED & GREEN	40mm	FMC	205mm	378g
3-9X42E	3-9x	RED & GREEN	42mm	FMC	190mm	380g
FFP 3-12X32AO	3-12x	RED & GREEN	32mm	FMC	196mm	404g

RETICLE OPTIONS

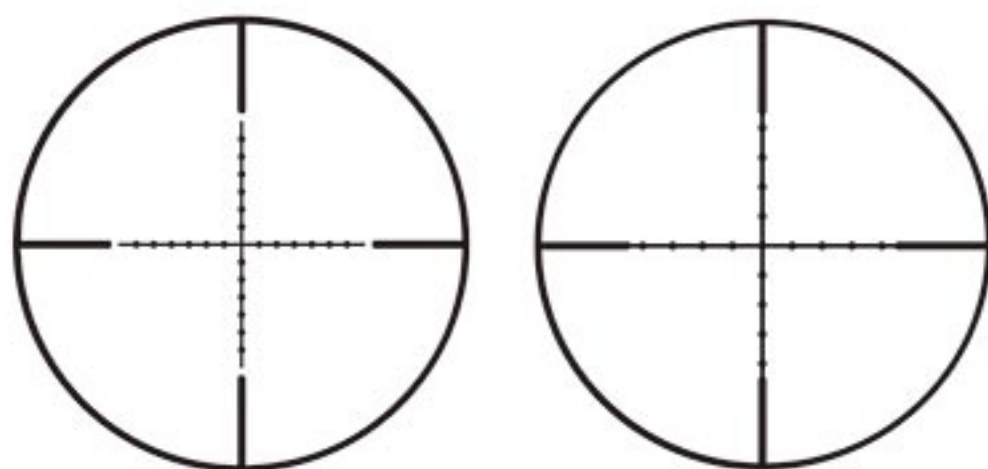

RETICLE COLORS



FOG RESISTANT



WATER RESISTANT



IMPACT RESISTANT





3.5×30 PRISMATIC SCOPE

TRI-ILLUMINATED W/TS MOUNT
 This scope has a fixed 3 times magnification with a 30mm objective lens. With adjustable reticle illumination which is 3 brightness levels in red, green and blue, allowing for better reticle visibility at night or in low light environments. Lightweight and durable performance exceeds your expectations. It is in black anodized aluminum construction and LED(light emitting diode) is 100% safe for eyes.



4×32 PRISMATIC SCOPE

TRI-ILLUMINATED W/TS MOUNT
 This fixed power scope is the perfect no nonsense optic for close to mid-range shooting. Equipped with an integrated slant cut shade helps reduce glare. A simple thumbscrew base makes the system equally user friendly with veteran shooters or casual hobbyists.



4×32 TRI-RAIL SCOPE

TRI-ILLUMINATED W/TS MOUNT
 The scope is perfect for short to mid-range targets. Three forward mounted picatinny rail panels offer the end user the greatest amount of adaptability in selection of mission specific accessories. It is also featured a fiber optic front back up sight, and removable rear iron sight. Prismatic series optics are your best choice for any CQB or intermediate distance shooting.



4×32 SCOPE-FIBER OPTIC SIGHT

TRI-ILLUMINATED W/TS MOUNT
 The scope is perfect for short to mid-range targets. Rail panels are mounted on either side of the objective bell in order to facilitate the attachment of additional mission specific accessories. It is also featured a fiber optic front back up sight, and removable rear iron sight. Prismatic series optics are your best choice for any CQB or intermediate distance shooting.

MODEL	MAGNIFICATION	ILLUMINATION	OBJECTIVE	EYE RELIEF	LENS COATING	LENGTH	WEIGHT
3.5×30 PRISMATIC SCOPE	3.5x	RED & GREEN & BLUE	30mm	76-89mm	GREEN	116mm	405g
4×32 SCOPE-FIBER OPTIC SIGHT	4x		32mm	76-89mm		153mm	465g
4×32 TRI-RAIL SCOPE	4x		32mm	76-89mm		151mm	468g
4×32 PRISMATIC SCOPE	4x		32mm	76-89mm		150mm	455g

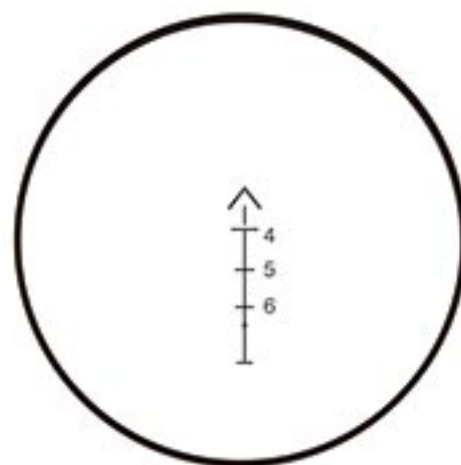
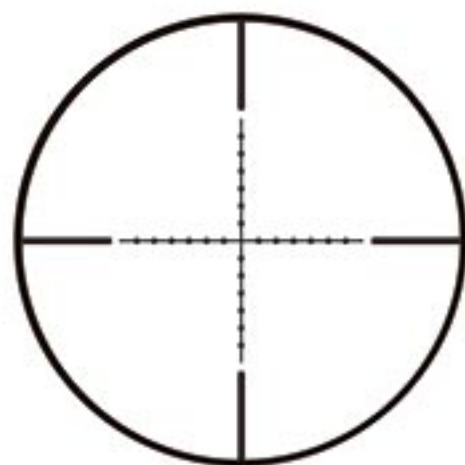

FOG RESISTANT



WATER RESISTANT



IMPACT RESISTANT





3-12X32 SCOPE-FIBER OPTIC SIGHT

It is a medium range scope featuring a fiber optic front back sight, and removeable rear iron sight. The adjustable magnification ring gives the user more choice.



4X32

TRI-ILLUMINATED W/TS MOUNT

The scope is perfect for short to mid-range targets. Rail panels are mounted on either side of the objective bell in order to facilitate the attachment of additional mission specific accessories. It is also featured a fiber optic front back up sight, and removeable rear iron sight. Prismatic series optics are your best choice for any CQB or intermediate distance shooting.

MODEL	MAGNIFICATION	ILLUMINATION	OBJECTIVE	EYE RELIEF	LENS COATING	LENGTH	WEIGHT
3-12X32	3-12x	RED & GREEN	32mm	76-89mm	GREEN	184mm	554g
4X32	4x	RED&GREEN&BLUE	32mm	76-89mm	GREEN	150mm	450g

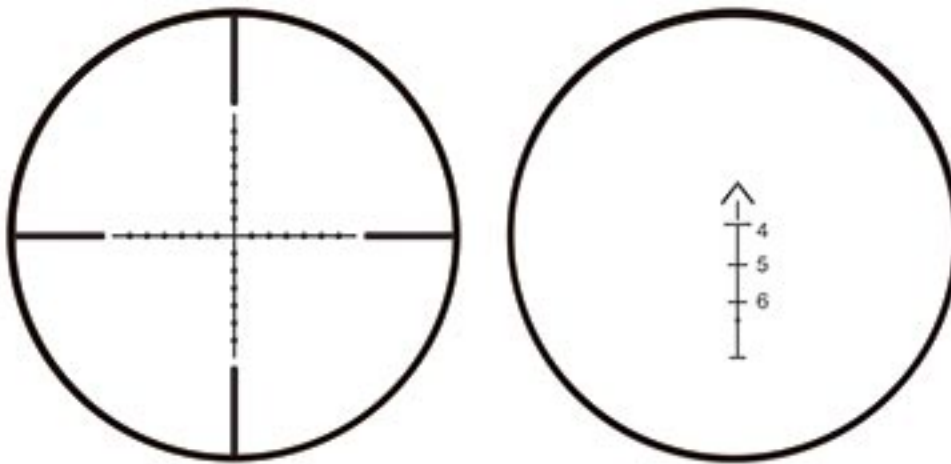

FOG RESISTANT



WATER RESISTANT



IMPACT RESISTANT



PRISM





Long eye relief scope comes with an one inch tube, and is easy to affix to rifles.

All lenses are meticulously polished to photographic quality for exceptional clarity and light gathering capability, which is especially critical during the low light hunting conditions of daybreak and dusk. It features a long eye relief for extended capability, making it a versatile shooting accessory.

Non-illuminated or dual-illuminated is available. Some models have excellent pull and push locking adjustment, providing great convenience. Before you adjust the reticle, pull the turret, and push it after the adjustment is done. Also, this scope can be zeroed.





2X20



2-7X32



3-9X42E

2×20 LONG EYE RELIEF

NON-ILLUMINATED

The LER 2×20 comes with a duplex reticle. Offering the shooter a wider than average magnification range, with smaller size objective lens, this scope works equally well on bolt action rifles, and handguns when a lower profile scope is required.

2-7×32 LONG EYE RELIEF

NON-ILLUMINATED OR DUAL-ILLUMINATED

Rangefinder reticle or Duplex Reticle is optional. Long Eye Relief (LER) optics are designed with a slim profile and low to medium magnification. These forward mounted optics are ideal choices for a wide variety of lever and bolt action rifles. LER scopes can also be used in conjunction with some pistols when target shooting and hunting.

3-9×42E LONG EYE RELIEF

DUAL-ILLUMINATED

The LER 3-9X42E is dual illuminated and equipped with a mil-dot reticle, delivering the wider field of view. Excellent pull and push locking adjustment provides great convenience. Once you reach the target goals, just lock it. Long Eye Relief (LER) optics are designed with a slim profile and low to medium magnification. It's an ideal choice for some pistols when target shooting and hunting.

MODEL	ILLUMINATION	TUBE DIAMETER	OBJECTIVE	EYE RELIEF	LENS COATING	LENGTH	WEIGHT	BATTERY
2X20		25.4mm	20mm	350-400mm	BLUE	218mm	189g	
2-7X32		25.4mm	32mm	250-300mm	BLUE	254mm	245g	
2-7X32E	RED & GREEN	25.4mm	32mm	250-300mm	BLUE	254mm	250g	CR2032
3-9X42E	RED & GREEN	25.4mm	42mm	250-300mm	FMC	230mm	380g	CR2032





4-16X44AOEYS
REGULAR TYPE

4-16X44AOEYS

The 4-16X44AOEYS is dual illuminated and equipped with a mil dot reticle, delivering the wider field of view. One inch tube with well designed optical system can provide bright and crisp image while maintain most lightweighted.



4-16X44AOEYS
REGULAR TYPE WITH LOCKING TURRET

4-16X44AOEYS

The 4-16X44AOEYS is dual illuminated and equipped with a mil dot reticle, delivering the wider field of view. One inch tube with well designed optical system can provide bright and crisp image while maintain most lightweighted. Excellent pull and push locking adjustment provides great convenience. Once you reach the target goals, just lock it.



4-16X44AOEYS
REGULAR TYPE WITH SIDE ILLUMINATION

4-16X44AOEYS

The 4-16X44AOEYS is dual illuminated and equipped with a mil dot reticle, delivering the wider field of view. One inch tube with well designed optical system can provide bright and crisp image while maintain most lightweighted. Excellent pull and push locking adjustment provides great convenience. Once you reach the target goals, just lock it.



4-16X44AOEYS
UPDATED TYPE WITH LOCKING TURRET AND SIDE ILLUMINATION

4-16X44AOEYS

The 4-16X44AOEYS is dual illuminated and equipped with a mil dot reticle, delivering the wider field of view. One inch tube with well designed optical system can provide bright and crisp image while maintain most lightweighted.





All AOL models are equipped with 25.4mm mono-tube chassis. They are machined from high-grade aluminum as well as precise parallax adjustments.

The adjustable objective makes you to win the optimal focus. Adjustment from 10 yards to infinity is maintained. Dual illumination provides a wonderful reticle view. It is undoubtedly the best choice for your hunting or shooting without paying too much.





3-9X32AOL



6-24X50AOL

MODEL	MAGNIFICATION	ILLUMINATION	TUBE DIAMETER	OBJECTIVE	RETICLE	EYE RELIEF	LENS COATING	LENGTH	WEIGHT	BATTERY
3-9X32AOL	3-9x	RED & GREEN & BLUE	25.4mm	32mm	Mil-Dot/ Glass etched	76-89mm	Green	220mm	393g	CR1620
3-9X40AOL	3-9x			40mm		76-89mm		340mm	530g	CR2032
3-9X50AOL	3-9x			50mm		76-89mm		332mm	665g	CR2032
3-12X40AOL	3-12x			40mm		76-89mm		340mm	585g	CR2032
4-16X40AOL	4-16x			40mm		76-89mm		385mm	610g	CR2032
4-16X50AOL	4-16x			50mm		76-89mm		400mm	670g	CR2032
6-24X50AOL	6-24x			50mm		76-89mm		410mm	680g	CR2032

RETICLE OPTIONS

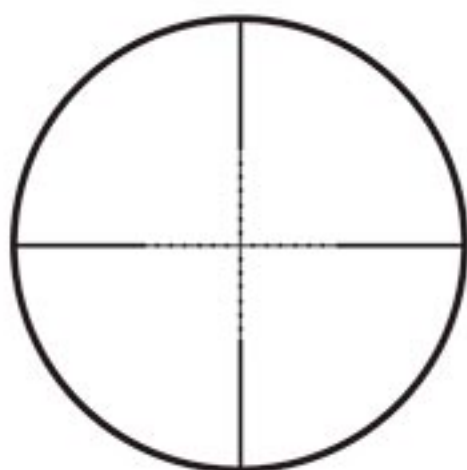

RETICLE COLORS



FOG RESISTANT



WATER RESISTANT



IMPACT RESISTANT





Selected models feature parallax adjustment. AO(adjustable objective) models will help to correct parallax error from 10 yards to infinity. Accessible parallax adjustment is positioned within easy reach whenever in close or long range shooting.

AOIR scopes feature a mono-tube chassis to provide stable and durable side illumination. Standardized mil-dot reticle designs mean AOIR scopes performing perfectly in almost any environment and can be equipped with any firearm.



AOIR SERIES



3-9X32AOIR



6-24X50AOIR

MODEL	MAGNIFICATION	ILLUMINATION	TUBE DIAMETER	OBJECTIVE	RETICLE	EYE RELIEF	LENS COATING	LENGTH	WEIGHT	BATTERY
3-9X32AOIR	3-9x	RED & GREEN	25.4mm	32mm	Mil-Dot/ Glass etched	76-89mm	Green	224mm	423g	CR2032
3-12X40AOIR	3-12x			40mm		76-89mm		333mm	660g	
4-16X40AOIR	4-16x			40mm		76-89mm		363mm	650g	
4-16X50AOIR	4-16x			50mm		76-89mm		377mm	685g	
6-24X50AOIR	6-24x			50mm		76-89mm		380mm	725g	

RETICLE OPTIONS

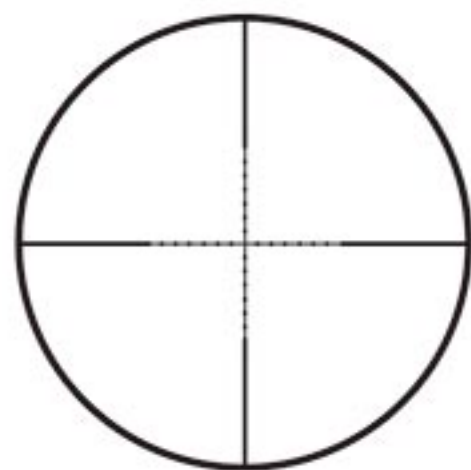

RETICLE COLORS



FOG RESISTANT



WATER RESISTANT



IMPACT RESISTANT





Simple and practical designs will provide a great help for shooting the target. AOEG series come with adjustable objectives, making it convenient to aim at the goal. Red and green illumination makes the target much clearer in the dim place.



AOEG SERIES



6-24X50AOEG

3-9X40AOGD

MODEL	MAGNIFICATION	ILLUMINATION	TUBE DIAMETER	OBJECTIVE	EYE RELIEF	LENS COATING	LENGTH	WEIGHT	BATTERY
3-9X32AOEG	3-9x	RED & GREEN	25.4mm	32mm	76-89mm	Multi-Coated	308mm	477g	CR2032
3-9X40AOEG	3-9x			40mm	76-89mm		323mm	545g	
3-9X50AOEG	3-9x			50mm	76-89mm		325mm	624g	
4-16X40AOEG	4-16x			40mm	76-89mm		354mm	560g	
4-16X50AOEG	4-16x			50mm	76-89mm		372mm	652g	
6-24X50AOEG	6-24x			50mm	76-89mm		405mm	680g	
3-9X40AOGD	3-9x			40mm	76-89mm		325mm	540g	

RETICLE OPTIONS

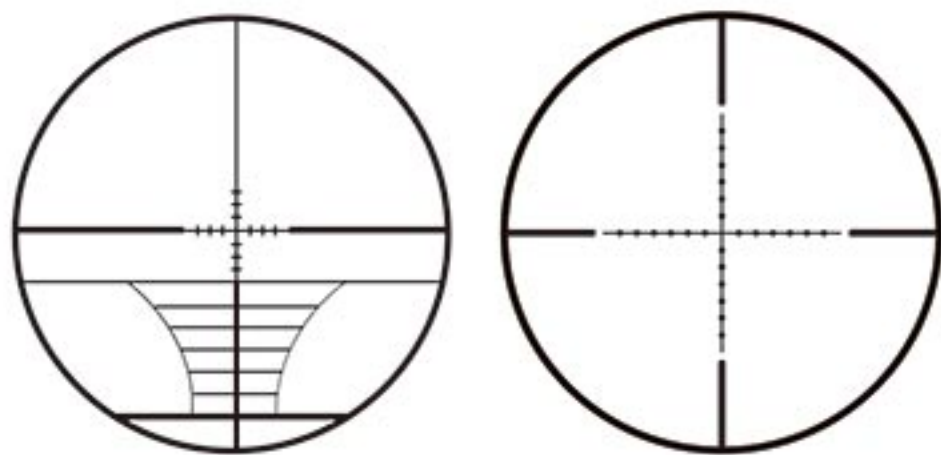

RETICLE COLORS



FOG RESISTANT



WATER RESISTANT



IMPACT RESISTANT





2-6X32EG

2-6X32EG

This ultra-compact scope is ideal for medium range shooting. This very small profile makes the shooter easily to mount the unit on nearly any type of rifles with equal utility.



2-6X32AOEG

2-6X32AOEG

This ultra-compact scope is ideal for medium range shooting. This very small profile makes the shooter easily to mount the unit on nearly any type of rifles with equal utility. The addition of a front parallax ring enables greater precision at longer rangers.



4X32AOEG

4X32AOEG

This ultra-compact scope is ideal for medium range shooting. This very small profile makes the shooter easily to mount the unit on nearly any type of rifles with equal utility. The addition of a front parallax ring enables greater precision at longer rangers.



4X32AOIR

4X32AOIR

This ultra-compact scope is ideal for medium range shooting. This very small profile makes the shooter easily to mount the unit on nearly any type of rifles with equal utility. The addition of a front parallax ring enables greater precision at longer rangers.





This classical scope is built on an ultra strong 1 inch machined-aluminum tube. Completely sealed and 100% nitrogen filled makes it fog and rain proof. Constructed with the great eyepiece allows for extra field of view and makes it able to eliminate most of image aberrations. The ocular is built with dioptic adjustment lens that can provide nearsighted and farsighted users a clear viewfinder image without the use of eyeglasses. Adjustable maximization with achronomatic eyepiece can eliminate image aberration. Red and green illumination reticle enables the scope to be used in diverse lighting conditions.





3-9X40

MODEL	MAGNIFICATION	TUBE DIAMETER	OBJECTIVE	EYE RELIEF	LENS COATING	LENGTH	WEIGHT
3-9X32	3-9x	25.4mm	32mm	76-89mm	BLUE	295mm	309g
3-9X40	3-9x		40mm	76-89mm		311mm	342g
3-9X40NG	3-9x		40mm	76-89mm		310mm	378g
3-9X50	3-9x		50mm	76-89mm		310mm	400g
3-9X56	3-9x		56mm	76-89mm		315mm	466g

RETICLE OPTIONS

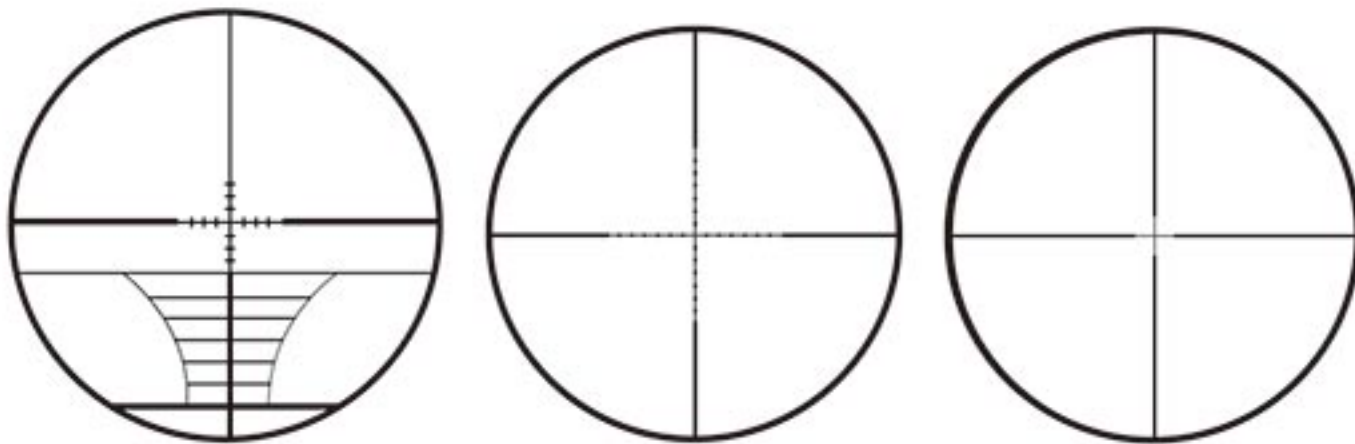

FOG RESISTANT



WATER RESISTANT



IMPACT RESISTANT





3-9X40EG

MODEL	MAGNIFICATION	ILLUMINATION	TUBE DIAMETER	OBJECTIVE	EYE RELIEF	LENS COATING	LENGTH	WEIGHT	BATTERY
3-9X32EG	3-9x	RED & GREEN	25.4mm	32mm	76-89mm	BLUE	298mm	403g	CR2032
3-9X40EG	3-9x			40mm	76-89mm		312mm	444g	
3-9X50EG	3-9x			50mm	76-89mm		312mm	505g	
3-12X56EG	3-12x			56mm	76-89mm		315mm	450g	

RETICLE OPTIONS

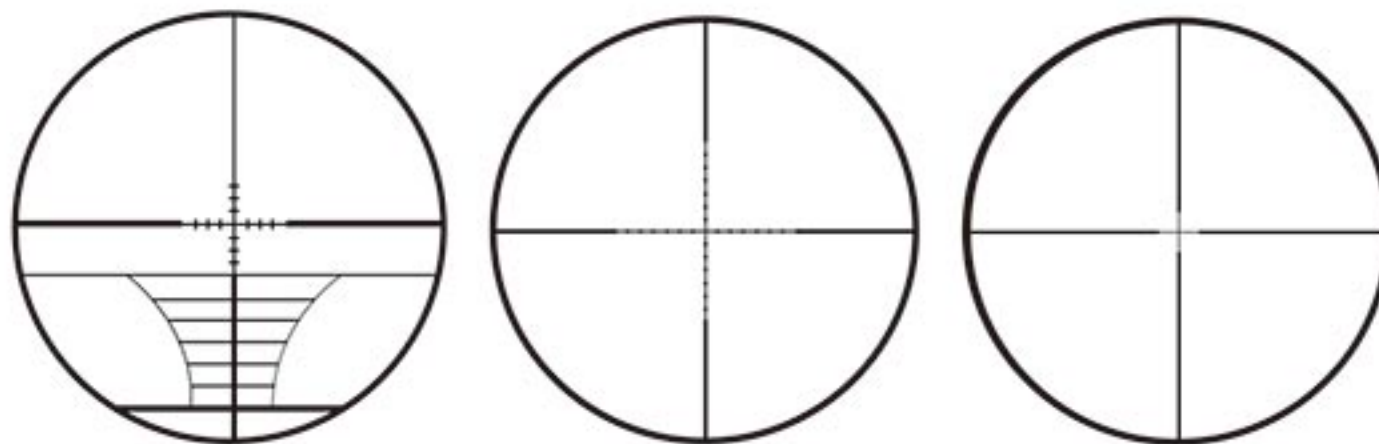

RETICLE COLORS



FOG RESISTANT



WATER RESISTANT



IMPACT RESISTANT





4X32L



4X32D

MODEL	MAGNIFICATION	TUBE DIAMETER	OBJECTIVE	EYE RELIEF	LENS COATING	LENGTH	WEIGHT
4X32L	4x	25.4mm	32mm	76-89mm	BLUE	285mm	251g
4X32D	4x		32mm	76-89mm		260mm	264g
4X32 (L=190MM)	4x		32mm	76-89mm		190mm	232g
4X40	4x		40mm	76-89mm		300mm	303g

RETICLE OPTIONS

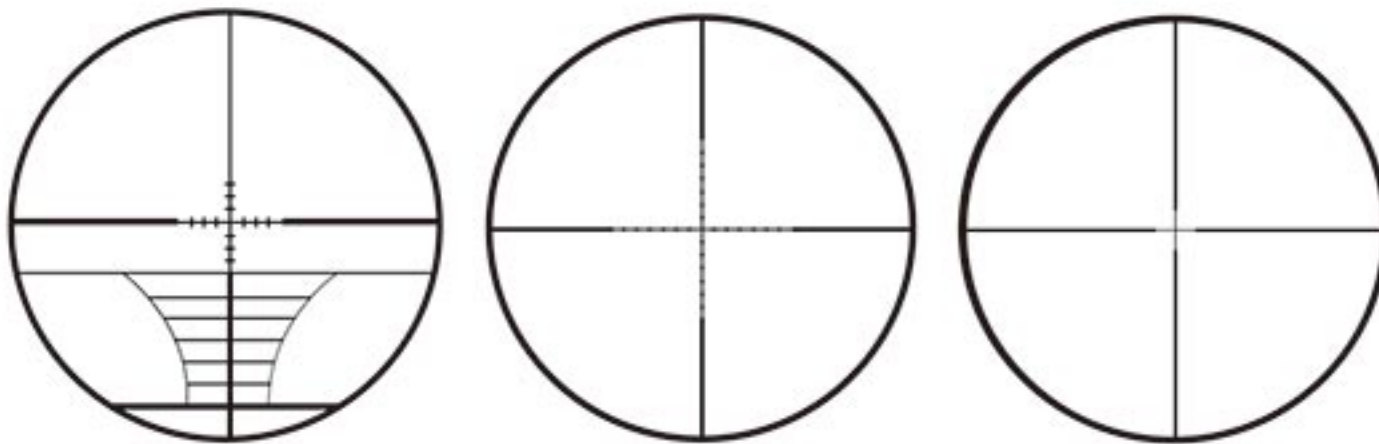

FOG RESISTANT



WATER RESISTANT



IMPACT RESISTANT





4X32EG



4X32EG SIDELIGHT



1.5-5X32EG

MODE	MAGNIFICATION	ILLUMINATION	TUBE DIAMETER	OBJECTIVE	EYE RELIEF	LENS COATING	LENGTH	WEIGHT	BATTERY
4X32EG	4x	RED & GREEN	25.4mm	32mm	76-89mm	BLUE	263mm	330g	CR2032
4X32EG SIDELIGHT	4x	RED & GREEN		32mm	76-89mm	BLUE	212mm	336g	CR2032
1.5-5X32EG	1.5-5x	RED & GREEN		32mm	76-89mm	BLUE	210mm	250g	CR2032

RETICLE OPTIONS

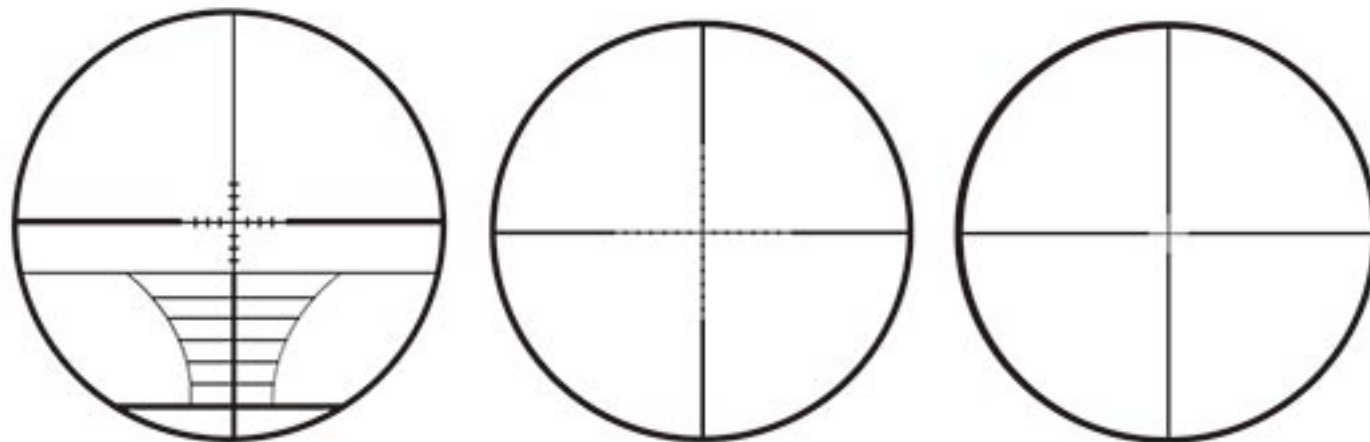

RETICLE COLORS



FOG RESISTANT

WATER RESISTANT

IMPACT RESISTANT





3-9X40AO



3-9X40NG

MODEL	MAGNIFICATION	TUBE DIAMETER	OBJECTIVE	EYE RELIEF	LENS COATING	LENGTH	WEIGHT
3-9X40AO	3-9x	25.4mm	40mm	76-89mm	BLUE	350mm	380g
3-9X40NG	3-9x		40mm	76-89mm	BLUE	310mm	378g

RETICLE OPTIONS

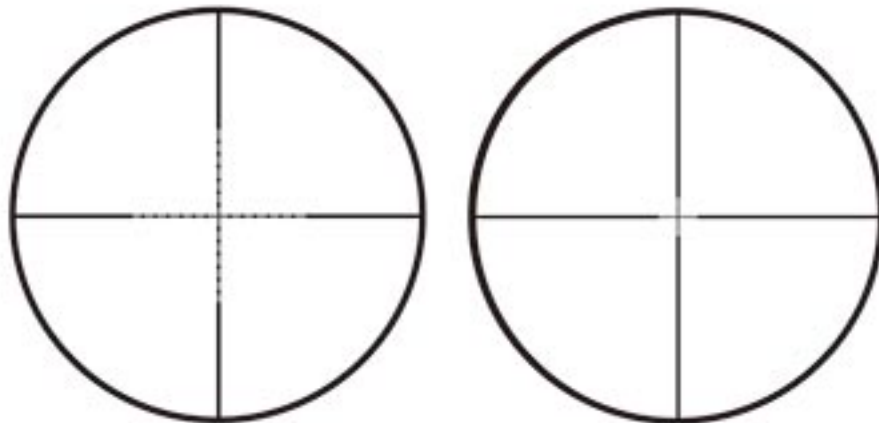

FOG RESISTANT



WATER RESISTANT



IMPACT RESISTANT





1.5-5X32



4X21

MODEL	MAGNIFICATION	TUBE DIAMETER	OBJECTIVE	EYE RELIEF	LENS COATING	LENGTH	WEIGHT
1.5-5X32	1.5-5x	25.4mm	32mm	76-89mm	BLUE	220mm	335g
4X21	4x		21mm	76-89mm	FMC	175mm	380g

RETICLE OPTIONS

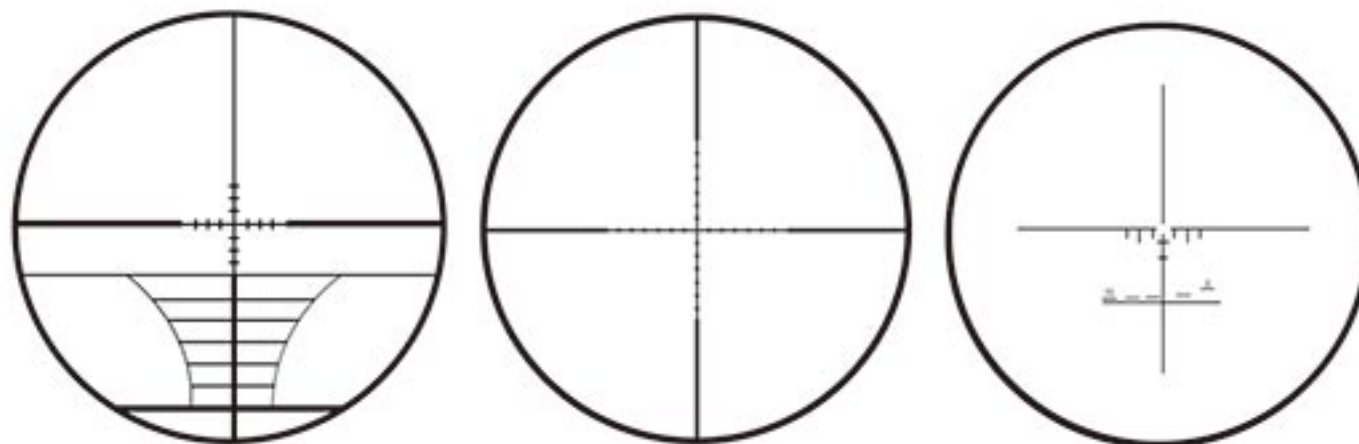

FOG RESISTANT



WATER RESISTANT



IMPACT RESISTANT





Combo scopes with electric control red dot sight laser and flashlight are good for quick acquisition and fast moving targets. The tactical scope is easy to zero and adjust for windage and elevation. Deluxe multi-coated lenses bring an advantage with maximum light transmission. Both laser system and reflex sight provide great versatility. Integrated rails offer ample space for accessories. User can easily install the other equipment such as flashlight, which will help you more in dark hunting environment.

We are dedicated to providing buyers with quality, easy to use, yet affordable firearms sighting systems.





RED DOT SIGHTS OPTIONS

Versatile red dot sight with dual illumination is available. The standard rail is equipped with quick detach function which makes great convenience for shooting.



HD119 HD119QD HD103 HD104 HD104QD



SCOPE OPTIONS

There are different kinds of scopes for your choosing. Scopes are used to aim at far target, and different magnification can be selected.



C3-9X32EG

C3-9X40EG

C4-12X50EG

C4-16X50EG

C3-9X40AOEG

C4-16X50AOEG





LASER SIGHT OPTION

This laser sights integrated with optics and electronics provide with a wide field of view. They are very suitable for fast aiming and shooting at stationary and moving targets.



FLASHLIGHTS OPTIONS

Flashlight can be selected. It will help a lot in dark condition, and target will be in brighter condition after turn on the flashlight, which is a great help for aiming.





C3-9X32EG

C3-9X32EG

This all-inclusive tactical scope with integral mount and accessory rails is perfect for lights, lasers or anything else you want to use to trick out your firearm.



C3-9X40EG

C3-9X40EG

This all-inclusive tactical scope with integral mount and accessory rails is perfect for lights, lasers or anything else you want to use to trick out your firearm.



C4-12X50EG

C4-12X50EG

This all-inclusive tactical scope with integral mount and accessory rails is perfect for lights, lasers or anything else you want to use to trick out your firearm. The slant cut shade helps reduce glare.



C4-16X50EG

C4-16X50EG

This all-inclusive tactical scope with integral mount and accessory rails is perfect for lights, lasers or anything else you want to use to trick out your firearm. Beautiful flower object lens makes your scope become unique.





C3-9X40AOEG

C3-9X40AOEG

This all-inclusive tactical scope with integral mount and accessory rails is perfect for lights, lasers or anything else you want to use to trick out your firearm. The addition of a front parallax ring enables greater precision at longer ranges.



C4-16X50AOEG

C4-16X50AOEG

This all-inclusive tactical scope with integral mount and accessory rails is perfect for lights, lasers or anything else you want to use to trick out your firearm. The addition of a front parallax ring enables greater precision at longer ranges.



C3-9X26EG

C3-9X26EG

This all-inclusive tactical scope with integral mount and accessory rails is perfect for lights, lasers or anything else you want to use to trick out your firearm.

MODEL	MAGNIFICATION	ILLUMINATION	TUBE DIAMETER	OBJECTIVE	EYE RELIEF	LENS COATING	LENGTH	WEIGHT	BATTERY
C3-9X32EG	3-9x	RED & GREEN	25.4mm	32mm	76-89mm	BLUE	305mm	543g	CR2032
C3-9X40EG	3-9x		25.4mm	40mm	76-89mm		312mm	572g	
C4-12X50EG	4-12x		25.4mm	50mm	76-89mm		328mm	635g	
C4-16X50EG	4-16x		25.4mm	50mm	76-89mm		330mm	640g	
C3-9X40AOEG	3-9x		25.4mm	40mm	76-89mm		315mm	655g	
C4-16X50AOEG	4-16x		25.4mm	50mm	76-89mm		325mm	810g	
C3-9X26EG	3-9x		25.4mm	26mm	76-89mm		188mm	380g	





4-14X44IR



FFP4-16X44IR

MODEL	MAGNIFICATION	ILLUMINATION	TUBE DIAMETER	OBJECTIVE	EYE RELIEF	LENS COATING	LENGTH	WEIGHT	BATTERY
4.5-18X50IR	4.5-18x	RED & GREEN	30mm	50mm	75-95mm	GREEN	342mm	630g	CR2032
4-14X44IR	4-14x			44mm	75-95mm		337mm	595g	
FFP5-20X50IR	5-20x			50mm	72.4-91mm		348mm	725g	
FFP4-16X44IR	4-16x			44mm	75.94-81.53mm		333mm	690g	

RETICLE OPTIONS

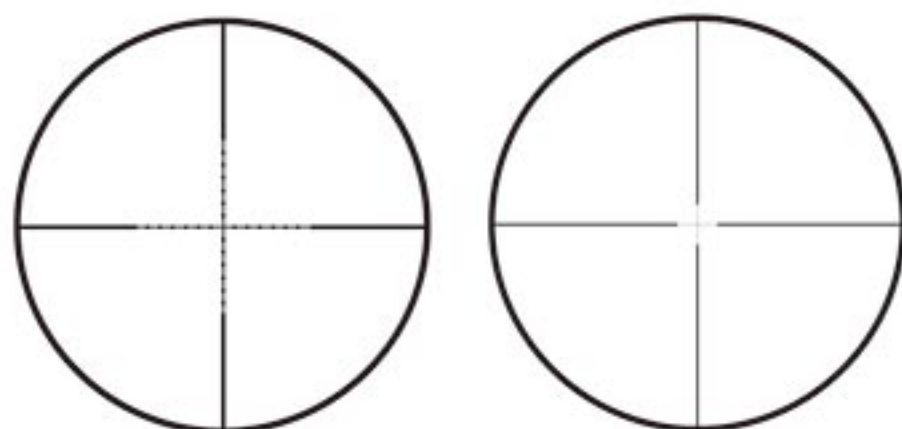

RETICLE COLORS



FOG RESISTANT



WATER RESISTANT



IMPACT RESISTANT





4.5-18X44AON



6-24X50AON

MODEL	MAGNIFICATION	ILLUMINATION	TUBE DIAMETER	OBJECTIVE	EYE RELIEF	LENS COATING	LENGTH	WEIGHT	BATTERY
4.5-18X44AON	4.5-18x	RED & GREEN	25.4mm	44mm	75-95mm	GREEN	356mm	655g	CR2032
6-24X50AON	6-24x			50mm	75-95mm		440mm	710g	

RETICLE OPTIONS

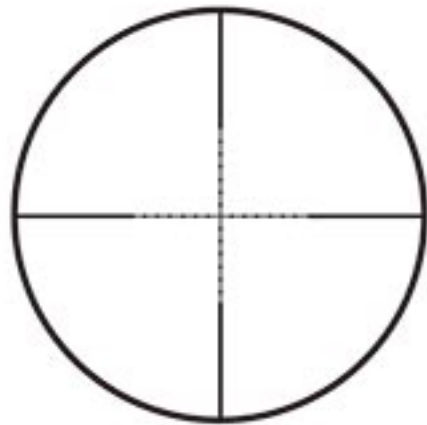

RETICLE COLORS



FOG RESISTANT



WATER RESISTANT



IMPACT RESISTANT





FFP4-14X44



1.2-6X24IR

MODEL	MAGNIFICATION	ILLUMINATION	TUBE DIAMETER	OBJECTIVE	EYE RELIEF	LENS COATING	LENGTH	WEIGHT	BATTERY
FFP4-14X44	4-14x	RED & GREEN	30mm	44mm	75.94-81.53mm	GREEN	360mm	745g	CR2032
1.2-6X24IR	1.2-6x			50mm	75.94-81.53mm		257mm	675g	

RETICLE OPTIONS

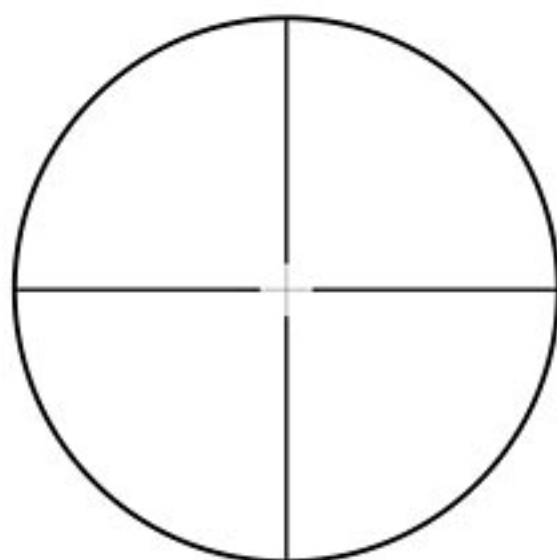

RETICLE COLORS



FOG RESISTANT



WATER RESISTANT



IMPACT RESISTANT





4X32



3-9X40IR

MODEL	MAGNIFICATION	ILLUMINATION	TUBE DIAMETER	OBJECTIVE	EYE RELIEF	LENS COATING	LENGTH	WEIGHT	BATTERY
4X32	4x	RED & GREEN	25.4mm	32mm	75-95mm	BLUE	206mm	294g	CR2032
3-9X40IR	3-9x			40mm	75-95mm	GREEN	194mm	331g	

RETICLE OPTIONS

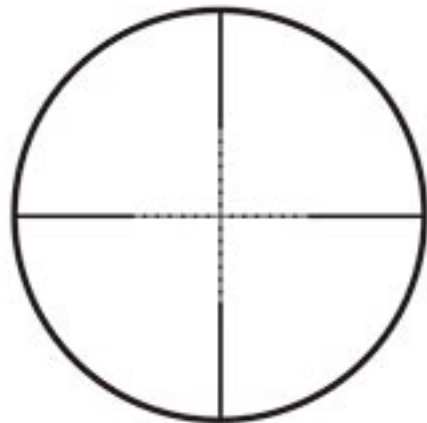

RETICLE COLORS



FOG RESISTANT



WATER RESISTANT



IMPACT RESISTANT





4001
1 inch



4002
1 inch



4003
1 inch



4033
1 inch



4014
1 inch



4015
1 inch



4016
30mm



4021
1 inch



4022
1 inch



4045
1 inch



4054
30mm



4056
1 inch



4020
1 inch



4091
K 185



4031



4079





4080



4005



4049



4077



4007



4048



Y0038



XTS 45



XTS 68E



XTS 68L



MT 012



XT005



201088200A





Nantong Chengxin Optical Instrument CO., LTD



V
VENATOR

WANGPAI

HI-Lux



C-MORE
SYSTEMS

TENPOINT

BEAMSHOT

ADD : WUJIE INDUSTRIAL PARK, TONGZHOU DISTRICT, NANTONG CITY,
JIANGSU PROVINCE, CHINA, 226361
TEL : (+86)513-86760911
E-MAIL: WYJ@NTANS.COM
KEVIN@SPIKESCOPE.COM

FOR MORE LATEST PRODUCTS,
PLS PAY ATTENTION TO OUR WEBSITE.



www.ntans.com



www.spike-scopes.com