

乐乐兄弟[®]
LELE BROTHER[®]

THE STORY OF BRICKS
积木的故事

此处翻开有意外惊喜
Open up to have big surprise



LELE BROTHER



© 2014 LELE BROTHER



Play and Learn!



GO GO GO!



品牌简介 乐乐兄弟® What is LELE BROTHER® ?

汕头市澄海区乐乐兄弟玩具有限公司，坐落于中国著名侨乡“中国玩具之都”——澄海。是一家集产品开发、生产、经营于一体的益智积木玩具生产公司。我们用有专业的设计团队、先进的生产厂房及精良的生产设备。所生产“乐乐兄弟”“乐乐姐妹”品牌系列产品畅销国内外。

本公司以开发具有益智性、趣味性、安全性等特点的儿童智

力玩具为导向，所生产的产品赢得广大商家及消费者的喜爱和认可。我们一贯注重产品的开发和创造，近年来以开发新系列化积木为主，采用优质材料，设计并生产出式样新颖，质量可靠的玩具积木系列。产品已全部获得国家3C认证及欧盟玩具安全EN71标准。

秉承着诚信、开拓、创新、进取的企业精神全力打造“乐乐兄弟”品牌。我们将不断开发、设计出益智、趣味、安全于一体的产品提供给广大客户。同时也热诚的欢迎海内外各界友人携手合作，共图发展。

SHANTOU CHENGHAI LELE BROTHER TOYS LIMITED, located in the most famous Toys City—Chenghai, specializes in making educational building block toys, we are an integrated enterprise with the ability to develop, produce and sell. We have professional design term, advanced production plant and superior manufacturing equipment. The production of “LELE BROTHER”, “LELE SISTER” Brand series sold at home and abroad.

Our company sticks to the guide to develop the intelligence, interesting and safety educational toys for children. Our products have won the love and recognition among numerous enterprises and consumers. We always put emphasis on product development and innovation, given priority to develop new series of building blocks in recent years, adopt high-quality materials, design and produce the novel style and quality building block toys series. All the products have passed domestic 3C certificate and European EN71 Toys Safety Standard.

Adhering to credible, pioneering and enterprising spirit, we effort to build our brand “LELE BROTHER”. We will continue to develop and design the intelligence, interesting and safety product to our customers, meanwhile we warmly welcome friends from all walks of life to joint hands with us and development together.



- 丙料积木 -----01
PP educational building blocks
- 乐高式积木 -----29
Lego type building blocks
- 钻石积木 -----47
ABS diamond building blocks



乐乐兄弟®
LELE BROTHER®

CONTENTS

THE STORY OF BRICKS
积木的故事



丙料积木

PP educational building blocks

NEW 03
2017新品
2017 New

07
动物系列
Animal Series

12
汽车系列
Car Series

21
足球系列
Football Series

25
罐装系列
Canned Series

27
袋装系列
Bag Series



此画册仅献给一直陪伴乐乐兄弟一起成长的可爱的人们!

This album of paintings is dedicated to people who have been accompanying with LELE BROTHER and growing up together!



LELE BROTHER



● 货号 (No.): 8327-1
规格 (Spec): 17.5X12.2X9.5cm
积木量 (Particles qty): 100g
装箱数 (QTY): 72pcs/2 inbox
外箱尺寸 (Meast): 78X45X42cm
毛/净重 (G./N.W): 14.7/11.7KG



● 货号 (No.): 8327-2
规格 (Spec): 17.5X12.2X9.5cm
积木量 (Particles qty): 165g
装箱数 (QTY): 72pcs/2 inbox
外箱尺寸 (Meast): 78X45X42cm
毛/净重 (G./N.W): 12.2/9.2KG



● 货号 (No.): 8327-3
规格 (Spec): 17.5X12.2X9.5cm
积木量 (Particles qty): 100g
装箱数 (QTY): 72pcs/2 inbox
外箱尺寸 (Meast): 78X45X42cm
毛/净重 (G./N.W): 14.7/11.7KG



● 货号 (No.): 8328-3
规格 (Spec): 17.2X12.2X10.8cm
积木量 (Particles qty): 65g
装箱数 (QTY): 72pcs/2 inbox
外箱尺寸 (Meast): 92X45X40cm
毛/净重 (G./N.W): 12.2/9.2KG



● 货号 (No.): 8328-5
规格 (Spec): 17.2X12.2X10.8cm
积木量 (Particles qty): 100g
装箱数 (QTY): 72pcs/2 inbox
外箱尺寸 (Meast): 92X45X40cm
毛/净重 (G./N.W): 14.7/11.7KG



● 货号 (No.): 8329-1
规格 (Spec): 17X12.2X10cm
积木量 (Particles qty): 100g
装箱数 (QTY): 72pcs/2 inbox
外箱尺寸 (Meast): 92X45X40cm
毛/净重 (G./N.W): 14.7/11.7KG



● 货号 (No.): 8329-2
规格 (Spec): 17X12.2X10cm
积木量 (Particles qty): 100g
装箱数 (QTY): 72pcs/2 inbox
外箱尺寸 (Meast): 92X45X40cm
毛/净重 (G./N.W): 14.7/11.7KG



● 货号 (No.): 8329-3
规格 (Spec): 17X12.2X10cm
积木量 (Particles qty): 65g
装箱数 (QTY): 72pcs/2 inbox
外箱尺寸 (Meast): 92X45X40cm
毛/净重 (G./N.W): 12.2/9.2KG



● 货号 (No.): 8329-5
规格 (Spec): 17.5X12.2X10.5cm
积木量 (Particles qty): 65g
装箱数 (QTY): 72pcs/2 inbox
外箱尺寸 (Meast): 92X45X40cm
毛/净重 (G./N.W): 12.2/9.2KG



● 货号 (No.): 8329-6
规格 (Spec): 17.5X12.2X10.5cm
积木量 (Particles qty): 100g
装箱数 (QTY): 72pcs/2 inbox
外箱尺寸 (Meast): 92X45X40cm
毛/净重 (G./N.W): 14.7/11.7KG



● 货号 (No.): 8327-5
规格 (Spec): 16.8X12.2X10cm
积木量 (Particles qty): 100g
装箱数 (QTY): 72pcs/2 inbox
外箱尺寸 (Meast): 92X45X40cm
毛/净重 (G./N.W): 14.7/11.7KG



● 货号 (No.): 8327-6
规格 (Spec): 16.8X12.2X10cm
积木量 (Particles qty): 65g
装箱数 (QTY): 72pcs/2 inbox
外箱尺寸 (Meast): 92X45X40cm
毛/净重 (G./N.W): 12.2/9.2KG



● 货号 (No.): 8328-1
规格 (Spec): 16.8X12.2X10cm
积木量 (Particles qty): 100g
装箱数 (QTY): 72pcs/2 inbox
外箱尺寸 (Meast): 92X45X40cm
毛/净重 (G./N.W): 14.7/11.7KG



● 货号 (No.): 8328-2
规格 (Spec): 17.2X12.2X10.8cm
积木量 (Particles qty): 100g
装箱数 (QTY): 72pcs/2 inbox
外箱尺寸 (Meast): 92X45X40cm
毛/净重 (G./N.W): 14.7/11.7KG



● 货号 (No.): 8329-6
规格 (Spec): 17.5X12.2X10.5cm
积木量 (Particles qty): 100g
装箱数 (QTY): 72pcs/2 inbox
外箱尺寸 (Meast): 92X45X40cm
毛/净重 (G./N.W): 14.7/11.7KG



● 货号 (No.): 8331-1
规格 (Spec): 25X17.5X17cm
积木量 (Particles qty): 250g
装箱数 (QTY): 24pcs/2 inbox
外箱尺寸 (Meast): 90X36X57cm
毛/净重 (G./N.W): 15/12.5KG



● 货号 (No.): 8331-2
规格 (Spec): 16.5X10.5X10cm
积木量 (Particles qty): 70g
装箱数 (QTY): 72pcs/2 inbox
外箱尺寸 (Meast): 85X42X39cm
毛/净重 (G./N.W): 9.3/6.3KG



● 货号 (No.): 8331-3
规格 (Spec): 21.5X15X11cm
积木量 (Particles qty): 200g
装箱数 (QTY): 72pcs/3 inbox
外箱尺寸 (Meast): 90X45X73cm
毛/净重 (G./N.W): 28.1/25.1KG



● 货号 (No.): 8332-1
规格 (Spec): 38X23X20.5cm
积木量 (Particles qty): 700g
装箱数 (QTY): 24pcs/2 inbox
外箱尺寸 (Meast): 88X58X78cm
毛/净重 (G./N.W): 28/25KG



● 货号 (No.): 8332-2
规格 (Spec): 38X23X20.5cm
积木量 (Particles qty): 540g
装箱数 (QTY): 24pcs/2 inbox
外箱尺寸 (Meast): 88X58X78cm
毛/净重 (G./N.W): 24.2/21.2KG



● 货号 (No.): 8331-5
规格 (Spec): 21.5X15X11cm
积木量 (Particles qty): 130g
装箱数 (QTY): 72pcs/3 inbox
外箱尺寸 (Meast): 90X45X73cm
毛/净重 (G./N.W): 23/20KG



● 货号 (No.): 8335-1
规格 (Spec): 41X23.5X19cm
积木量 (Particles qty): 700g
装箱数 (QTY): 24pcs/2 inbox
外箱尺寸 (Meast): 90X50X88cm
毛/净重 (G./N.W): 28.1/25.1KG



● 货号 (No.): 8332-3
规格 (Spec): 35X21X16cm
积木量 (Particles qty): 430g
装箱数 (QTY): 24pcs/2 inbox
外箱尺寸 (Meast): 80X40X76cm
毛/净重 (G./N.W): 19/16KG



● 货号 (No.): 8332-5
规格 (Spec): 35X21X16cm
积木量 (Particles qty): 320g
装箱数 (QTY): 24pcs/2 inbox
外箱尺寸 (Meast): 80X40X76cm
毛/净重 (G./N.W): 16.3/13.3KG



● 货号 (No.): 8332-6
规格 (Spec): 25X17.5X17cm
积木量 (Particles qty): 200g
装箱数 (QTY): 24pcs/2 inbox
外箱尺寸 (Meast): 90X36X57cm
毛/净重 (G./N.W): 13/10KG



● 货号 (No.): 8335-2
规格 (Spec): 41X23.5X19cm
积木量 (Particles qty): 600g
装箱数 (QTY): 24pcs/2 inbox
外箱尺寸 (Meast): 90X50X88cm
毛/净重 (G./N.W): 25.7/22.7KG



● 货号 (No.): 8335-3
规格 (Spec): 35X21X16cm
积木量 (Particles qty): 450g
装箱数 (QTY): 24pcs/2 inbox
外箱尺寸 (Meast): 80*40*76cm
毛/净重 (G./N.W): 20/16.5KG



● 货号 (No.): 8333-1
规格 (Spec): 25X17.5X17cm
积木量 (Particles qty): 250g
装箱数 (QTY): 24pcs/2 inbox
外箱尺寸 (Meast): 90X36X57cm
毛/净重 (G./N.W): 15/12.5KG



● 货号 (No.): 8333-2
规格 (Spec): 17X10.5X10.5cm
积木量 (Particles qty): 70g
装箱数 (QTY): 72pcs/2 inbox
外箱尺寸 (Meast): 85X42X39cm
毛/净重 (G./N.W): 10.2/7.2KG



● 货号 (No.): 8333-3
规格 (Spec): 21X15.2X12cm
积木量 (Particles qty): 200g
装箱数 (QTY): 72pcs/2 inbox
外箱尺寸 (Meast): 90X45X73cm
毛/净重 (G./N.W): 28.1/25.1KG



● 货号 (No.): 8335-5
规格 (Spec): 35X21X16cm
积木量 (Particles qty): 350g
装箱数 (QTY): 24pcs/2 inbox
外箱尺寸 (Meast): 80*40*76cm
毛/净重 (G./N.W): 18/15KG



● 货号 (No.): 8335-6
规格 (Spec): 25X17.5X17cm
积木量 (Particles qty): 200g
装箱数 (QTY): 24pcs/2 inbox
外箱尺寸 (Meast): 90X36X57cm
毛/净重 (G./N.W): 13/10KG



● 货号 (No.): 8333-5
规格 (Spec): 21X15.2X12cm
积木量 (Particles qty): 130g
装箱数 (QTY): 72pcs/2 inbox
外箱尺寸 (Meast): 90X45X73cm
毛/净重 (G./N.W): 28.1/25.1KG

ANIMAL
SERIES
动物系列



可爱的蜗牛
SNAIL

- 货号 (No.): 8118-1
- 规格 (Spec): 26X22X24cm
- 积木量 (Particles qty): 150g
- 装箱数 (QTY): 12pcs/2 inbox
- 外箱尺寸 (Meast): 82X50X52cm
- 毛/净重 (G./N.W): 9.6/6.6KG



- 货号 (No.): 8118-6
- 规格 (Spec): 26X22X24cm
- 积木量 (Particles qty): 140g
- 装箱数 (QTY): 12pcs/2 inbox
- 外箱尺寸 (Meast): 82X50X52cm
- 毛/净重 (G./N.W): 9.5/6.5KG



- 货号 (No.): 8118-2
- 规格 (Spec): 26X22X24cm
- 积木量 (Particles qty): 19pcs
- 装箱数 (QTY): 12pcs/2 inbox
- 外箱尺寸 (Meast): 82X50X52cm
- 毛/净重 (G./N.W): 9.3/6.3KG



- 货号 (No.): 8118-3
- 规格 (Spec): 26X22X24cm
- 积木量 (Particles qty): 200g
- 装箱数 (QTY): 12pcs/2 inbox
- 外箱尺寸 (Meast): 82X50X52cm
- 毛/净重 (G./N.W): 10.2/7.2KG





可爱的螃蟹
SOLDIER CRAB



- 货号 (No.): 8119-1
- 规格 (Spec): 26X18X24cm
- 积木量 (Particles qty): 150g
- 装箱数 (QTY): 12pcs/2 inbox
- 外箱尺寸 (Meast): 82X42X52cm
- 毛/净重 (G./N.W): 9.6/6.6KG



- 货号 (No.): 8119-2
- 规格 (Spec): 26X18X24cm
- 积木量 (Particles qty): 19pcs
- 装箱数 (QTY): 12pcs/2 inbox
- 外箱尺寸 (Meast): 82X42X52cm
- 毛/净重 (G./N.W): 9.3/6.3KG



- 货号 (No.): 8119-3
- 规格 (Spec): 26X18X24cm
- 积木量 (Particles qty): 200g
- 装箱数 (QTY): 12pcs/2 inbox
- 外箱尺寸 (Meast): 82X42X52cm
- 毛/净重 (G./N.W): 10.2/7.2KG



- 货号 (No.): 8119-6
- 规格 (Spec): 26X18X24cm
- 积木量 (Particles qty): 110g
- 装箱数 (QTY): 12pcs/2 inbox
- 外箱尺寸 (Meast): 82X42X52cm
- 毛/净重 (G./N.W): 9.1/6.1KG

可爱的大象
ELEPHANT



- 货号 (No.): 8121-2
- 规格 (Spec): 30X25.5X23cm
- 积木量 (Particles qty): 200pcs
- 装箱数 (QTY): 12pcs/2 inbox
- 外箱尺寸 (Meast): 94X55X50cm
- 毛/净重 (G./N.W): 10.4/7.4KG



- 货号 (No.): 8121-6
- 规格 (Spec): 30X25.5X23cm
- 积木量 (Particles qty): 140g
- 装箱数 (QTY): 12pcs/2 inbox
- 外箱尺寸 (Meast): 94X55X50cm
- 毛/净重 (G./N.W): 10/7KG



- 货号 (No.): 8121-1
- 规格 (Spec): 30X25.5X23cm
- 积木量 (Particles qty): 200g
- 装箱数 (QTY): 12pcs/2 inbox
- 外箱尺寸 (Meast): 94X55X50cm
- 毛/净重 (G./N.W): 10.7/7.7KG



- 货号 (No.): 8121-3
- 规格 (Spec): 30X25.5X23cm
- 积木量 (Particles qty): 250g
- 装箱数 (QTY): 12pcs/2 inbox
- 外箱尺寸 (Meast): 94X55X50cm
- 毛/净重 (G./N.W): 11.3/8.3KG



● 货号 (No.): 8131-1
规格 (Spec): 13.5X14.5X21cm
积木量 (Particles qty): 90g
装箱数 (QTY): 36pcs/2 in box
外箱尺寸 (Meast): 90X44X47cm
毛/净重 (G./N.W): 12/9KG



● 货号 (No.): 8131-3
规格 (Spec): 13.5X14.5X21cm
积木量 (Particles qty): 150g
装箱数 (QTY): 36pcs/2 in box
外箱尺寸 (Meast): 90X44X47cm
毛/净重 (G./N.W): 14.2/11.2KG



● 货号 (No.): 8131W-1
规格 (Spec): 13.5X14.5X21cm
积木量 (Particles qty): 90g
装箱数 (QTY): 36pcs/2 in box
外箱尺寸 (Meast): 90X44X47cm
毛/净重 (G./N.W): 12/9KG



● 货号 (No.): 8131W-3
规格 (Spec): 13.5X14.5X21cm
积木量 (Particles qty): 150g
装箱数 (QTY): 36pcs/2 in box
外箱尺寸 (Meast): 90X44X47cm
毛/净重 (G./N.W): 14.2/11.2KG



● 货号 (No.): 8131Y-1
规格 (Spec): 13.5X14.5X21cm
积木量 (Particles qty): 90g
装箱数 (QTY): 36pcs/2 in box
外箱尺寸 (Meast): 90X44X47cm
毛/净重 (G./N.W): 12/9KG



● 货号 (No.): 8131Y-3
规格 (Spec): 13.5X14.5X21cm
积木量 (Particles qty): 150g
装箱数 (QTY): 36pcs/2 in box
外箱尺寸 (Meast): 90X44X47cm
毛/净重 (G./N.W): 14.2/11.2KG





● 货号 (No.): 8132-1
规格 (Spec): 35X21X16cm
积木量 (Particles qty): 430g
装箱数 (QTY): 24pcs/2 inbox
外箱尺寸 (Meast): 80X40X76cm
毛/净重 (G./N.W): 19/16KG



● 货号 (No.): 8132-6
规格 (Spec): 35X21X16cm
积木量 (Particles qty): 320g
装箱数 (QTY): 24pcs/2 inbox
外箱尺寸 (Meast): 80X40X76cm
毛/净重 (G./N.W): 16.3/13.3KG



● 货号 (No.): 8139-1
规格 (Spec): 26X16X12cm
积木量 (Particles qty): 160g
装箱数 (QTY): 72pcs/3 inbox
外箱尺寸 (Meast): 85X45X86cm
毛/净重 (G./N.W): 25.1/22.1KG



● 货号 (No.): 8132-2
规格 (Spec): 35X21X16cm
积木量 (Particles qty): 44pcs
装箱数 (QTY): 24pcs/2 inbox
外箱尺寸 (Meast): 80X40X76cm
毛/净重 (G./N.W): 16.2/13.2KG



● 货号 (No.): 8132-3
规格 (Spec): 35X21X16cm
积木量 (Particles qty): 580g
装箱数 (QTY): 24pcs/2 inbox
外箱尺寸 (Meast): 80X40X76cm
毛/净重 (G./N.W): 22.6/19.6KG

● 货号 (No.): 8139-3
规格 (Spec): 26X16X12cm
积木量 (Particles qty): 220g
装箱数 (QTY): 72pcs/3 inbox
外箱尺寸 (Meast): 85X45X86cm
毛/净重 (G./N.W): 29.2/26.2KG



● 货号 (No.): 8310-1
规格 (Spec): 18.3X9.5X7.3 cm
积木量 (Particles qty): 50g
装箱数 (QTY): 120pcs/2 inbox
外箱尺寸 (Meast): 84X50X41cm
毛/净重 (G./N.W): 15.9/12.6KG



● 货号 (No.): 8162-1
规格 (Spec): 41X23.5X19cm
积木量 (Particles qty): 600g
装箱数 (QTY): 24pcs/2 inbox
外箱尺寸 (Meast): 90X50X88cm
毛/净重 (G./N.W): 25.7/22.7KG



● 货号 (No.): 8162-2
规格 (Spec): 41X23.5X19cm
积木量 (Particles qty): 72pcs
装箱数 (QTY): 24pcs/2 inbox
外箱尺寸 (Meast): 90X50X88cm
毛/净重 (G./N.W): 23.3/20.3KG



● 货号 (No.): 8133-1
规格 (Spec): 32X18X13cm
积木量 (Particles qty): 220g
装箱数 (QTY): 48pcs/2 inbox
外箱尺寸 (Meast): 90X46X68cm
毛/净重 (G./N.W): 21.2/18.2KG



● 货号 (No.): 8133-3
规格 (Spec): 32X18X13cm
积木量 (Particles qty): 320g
装箱数 (QTY): 48pcs/2 inbox
外箱尺寸 (Meast): 90X46X68cm
毛/净重 (G./N.W): 26/23KG



● 货号 (No.): 8162-5
规格 (Spec): 41X23.5X19cm
积木量 (Particles qty): 29pcs
装箱数 (QTY): 24pcs/2 inbox
外箱尺寸 (Meast): 90X50X88cm
毛/净重 (G./N.W): 24.5/21.5KG



● 货号 (No.): 8162-6
规格 (Spec): 41X23.5X19cm
积木量 (Particles qty): 500g
装箱数 (QTY): 24pcs/2 inbox
外箱尺寸 (Meast): 90X50X88cm
毛/净重 (G./N.W): 23.3/20.3KG



● 货号 (No.): 8133-2
规格 (Spec): 32X18X13cm
积木量 (Particles qty): 24pcs
装箱数 (QTY): 48pcs/2 inbox
外箱尺寸 (Meast): 90X46X68cm
毛/净重 (G./N.W): 18.7/15.7KG



● 货号 (No.): 8133-6
规格 (Spec): 32X18X13cm
积木量 (Particles qty): 180g
装箱数 (QTY): 48pcs/2 inbox
外箱尺寸 (Meast): 90X46X68cm
毛/净重 (G./N.W): 18.2/15.2KG



● 货号 (No.): 3110-3
规格 (Spec): 26X16X12cm
积木量 (Particles qty): 250g
装箱数 (QTY): 72pcs/3 inbox
外箱尺寸 (Meast): 85X45X86cm
毛/净重 (G./N.W): 30.3/27.3KG



● 货号 (No.): 3110-1
规格 (Spec): 26X16X12cm
积木量 (Particles qty): 180g
装箱数 (QTY): 72pcs/3 inbox
外箱尺寸 (Meast): 85X45X86cm
毛/净重 (G./N.W): 24.2/21.2KG



● 货号 (No.): 3111-1
规格 (Spec): 32X18X13cm
积木量 (Particles qty): 250g
装箱数 (QTY): 48pcs/2 inbox
外箱尺寸 (Meast): 100X46X68cm
毛/净重 (G./N.W): 23/20KG



● 货号 (No.): 6111-1
规格 (Spec): 25X17.5X17cm
积木量 (Particles qty): 250g
装箱数 (QTY): 24pcs/2 inbox
外箱尺寸 (Meast): 90X36X57cm
毛/净重 (G./N.W): 15/12.5KG



● 货号 (No.): 6111-3
规格 (Spec): 25X17.5X17cm
积木量 (Particles qty): 350g
装箱数 (QTY): 24pcs/2 inbox
外箱尺寸 (Meast): 90X36X57cm
毛/净重 (G./N.W): 16/13.7KG



● 货号 (No.): 8317-1
规格 (Spec): 17X11X10.5cm
积木量 (Particles qty): 70g
装箱数 (QTY): 72pcs/2 inbox
外箱尺寸 (Meast): 85X42X39cm
毛/净重 (G./N.W): 12.4/9.3KG



● 货号 (No.): 3111-2
规格 (Spec): 32X18X13cm
积木量 (Particles qty): 24pcs
装箱数 (QTY): 48pcs/2 inbox
外箱尺寸 (Meast): 100X46X68cm
毛/净重 (G./N.W): 19.9/16.9KG



● 货号 (No.): 3111-3
规格 (Spec): 32X18X13cm
积木量 (Particles qty): 350g
装箱数 (QTY): 48pcs/2 inbox
外箱尺寸 (Meast): 100X46X68cm
毛/净重 (G./N.W): 27.8/24.8KG



● 货号 (No.): 6111-2
规格 (Spec): 25X17.5X17cm
积木量 (Particles qty): 24pcs
装箱数 (QTY): 24pcs/2 inbox
外箱尺寸 (Meast): 90X36X57cm
毛/净重 (G./N.W): 12/9.6KG



● 货号 (No.): 6111-6
规格 (Spec): 25X17.5X17cm
积木量 (Particles qty): 200g
装箱数 (QTY): 24pcs/2 inbox
外箱尺寸 (Meast): 90X36X57cm
毛/净重 (G./N.W): 13/10KG



● 货号 (No.): 8318-1
规格 (Spec): 17X11X10.5cm
积木量 (Particles qty): 50g
装箱数 (QTY): 72pcs/2 inbox
外箱尺寸 (Meast): 85X42X39cm
毛/净重 (G./N.W): 11/7.9KG

● 货号 (No.): 3111-6
规格 (Spec): 32X18X13cm
积木量 (Particles qty): 200g
装箱数 (QTY): 48pcs/2 inbox
外箱尺寸 (Meast): 100X46X68cm
毛/净重 (G./N.W): 21.8/18.8KG



● 货号 (No.): 3112-1
规格 (Spec): 35X21X16cm
积木量 (Particles qty): 450g
装箱数 (QTY): 24pcs/2 inbox
外箱尺寸 (Meast): 80X40X76cm
毛/净重 (G./N.W): 20/16.5KG



● 货号 (No.): 3112-2
规格 (Spec): 35X21X16cm
积木量 (Particles qty): 48pcs
装箱数 (QTY): 24pcs/2 inbox
外箱尺寸 (Meast): 80X40X76cm
毛/净重 (G./N.W): 17.5/14KG



● 货号 (No.): 6112-1
规格 (Spec): 28X17.5X17cm
积木量 (Particles qty): 250g
装箱数 (QTY): 24pcs/2 inbox
外箱尺寸 (Meast): 86X36X63cm
毛/净重 (G./N.W): 15/12.5KG



● 货号 (No.): 6112-3
规格 (Spec): 28X17.5X17cm
积木量 (Particles qty): 350g
装箱数 (QTY): 24pcs/2 inbox
外箱尺寸 (Meast): 86X36X62cm
毛/净重 (G./N.W): 16/13.7KG



● 货号 (No.): 8317-3
规格 (Spec): 17X11X10.5cm
积木量 (Particles qty): 70g
装箱数 (QTY): 72pcs/2 inbox
外箱尺寸 (Meast): 85X42X39cm
毛/净重 (G./N.W): 12.4/9.3KG



● 货号 (No.): 3112-3
规格 (Spec): 35X21X16cm
积木量 (Particles qty): 600g
装箱数 (QTY): 24pcs/2 inbox
外箱尺寸 (Meast): 80X40X76cm
毛/净重 (G./N.W): 23.5/20KG



● 货号 (No.): 3112-6
规格 (Spec): 35X21X16cm
积木量 (Particles qty): 350g
装箱数 (QTY): 24pcs/2 inbox
外箱尺寸 (Meast): 80X40X76cm
毛/净重 (G./N.W): 18/15KG



● 货号 (No.): 6112-2
规格 (Spec): 28X17.5X17cm
积木量 (Particles qty): 30pcs
装箱数 (QTY): 24pcs/2 inbox
外箱尺寸 (Meast): 86X36X63cm
毛/净重 (G./N.W): 13/10.6KG



● 货号 (No.): 6112-6
规格 (Spec): 28X17.5X17cm
积木量 (Particles qty): 200g
装箱数 (QTY): 24pcs/2 inbox
外箱尺寸 (Meast): 86X36X62cm
毛/净重 (G./N.W): 13/10.5KG



● 货号 (No.): 8318-3
规格 (Spec): 17X11X10.5cm
积木量 (Particles qty): 50g
装箱数 (QTY): 72pcs/2 inbox
外箱尺寸 (Meast): 85X42X39cm
毛/净重 (G./N.W): 11/7.9KG



● 货号 (No.): 8317-2
规格 (Spec): 16.5X10.5X10cm
积木量 (Particles qty): 119pcs
装箱数 (QTY): 72pcs/2 inbox
外箱尺寸 (Meast): 85X42X39cm
毛/净重 (G./N.W): 9.3/6.3KG



● 货号 (No.): 8318-2
规格 (Spec): 16.5X10.5X10cm
积木量 (Particles qty): 109pcs
装箱数 (QTY): 72pcs/2 inbox
外箱尺寸 (Meast): 85X42X39cm
毛/净重 (G./N.W): 11/7.9KG



● 货号 (No.): 6113-1
规格 (Spec): 25X17.5X17cm
积木量 (Particles qty): 250g
装箱数 (QTY): 24pcs/2 inbox
外箱尺寸 (Meast): 90X36X57cm
毛/净重 (G./N.W): 15/12.5KG



● 货号 (No.): 6113-2
规格 (Spec): 25X17.5X17cm
积木量 (Particles qty): 30pcs
装箱数 (QTY): 24pcs/2 inbox
外箱尺寸 (Meast): 90X36X57cm
毛/净重 (G./N.W): 13/10.6KG



● 货号 (No.): 6113-3
规格 (Spec): 25X17.5X17cm
积木量 (Particles qty): 350g
装箱数 (QTY): 24pcs/2 inbox
外箱尺寸 (Meast): 90X36X57cm
毛/净重 (G./N.W): 16/13.7KG



● 货号 (No.): 6113-6
规格 (Spec): 25X17.5X17cm
积木量 (Particles qty): 200g
装箱数 (QTY): 24pcs/2 inbox
外箱尺寸 (Meast): 90X36X57cm
毛/净重 (G./N.W): 13/10.5KG



● 货号 (No.): 8165-5
规格 (Spec): 21X15.2X12cm
积木量 (Particles qty): 130g
装箱数 (QTY): 72pcs/3 inbox
外箱尺寸 (Meast): 90X45X73cm
毛/净重 (G./N.W): 22.7/19.7KG



● 货号 (No.): 8165-6
规格 (Spec): 21.5X15.5X12.5cm
积木量 (Particles qty): 150g
装箱数 (QTY): 72pcs/3 inbox
外箱尺寸 (Meast): 90X45X73cm
毛/净重 (G./N.W): 24.7/21.7KG



● 货号 (No.): 8165-7
规格 (Spec): 22X15X13cm
积木量 (Particles qty): 150g
装箱数 (QTY): 72pcs/3 inbox
外箱尺寸 (Meast): 90X45X73cm
毛/净重 (G./N.W): 24.7/21.7KG



● 货号 (No.): 8166-5
规格 (Spec): 21X15.2X12cm
积木量 (Particles qty): 200g
装箱数 (QTY): 72pcs/3 inbox
外箱尺寸 (Meast): 90X45X73cm
毛/净重 (G./N.W): 28.1/25.1KG



● 货号 (No.): 8166-6
规格 (Spec): 21.5X15.5X12.5cm
积木量 (Particles qty): 230g
装箱数 (QTY): 72pcs/3 inbox
外箱尺寸 (Meast): 90X45X73cm
毛/净重 (G./N.W): 28.3/25.3KG



● 货号 (No.): 8166-7
规格 (Spec): 22X15X13cm
积木量 (Particles qty): 230g
装箱数 (QTY): 72pcs/3 inbox
外箱尺寸 (Meast): 90X45X73cm
毛/净重 (G./N.W): 28.4/25.4KG



● 货号 (No.): 8165-1
规格 (Spec): 21.5X15X12cm
积木量 (Particles qty): 130g
装箱数 (QTY): 72pcs/3 inbox
外箱尺寸 (Meast): 90X45X73cm
毛/净重 (G./N.W): 22.7/19.7KG



● 货号 (No.): 8165-2
规格 (Spec): 21X15X10cm
积木量 (Particles qty): 130g
装箱数 (QTY): 72pcs/3 inbox
外箱尺寸 (Meast): 90X45X73cm
毛/净重 (G./N.W): 22.7/19.7KG



● 货号 (No.): 8165-3
规格 (Spec): 21.5X15X11cm
积木量 (Particles qty): 130g
装箱数 (QTY): 72pcs/3 inbox
外箱尺寸 (Meast): 90X45X73cm
毛/净重 (G./N.W): 23/20KG



● 货号 (No.): 8166-1
规格 (Spec): 21.5X15X12cm
积木量 (Particles qty): 200g
装箱数 (QTY): 72pcs/3 inbox
外箱尺寸 (Meast): 90X45X73cm
毛/净重 (G./N.W): 27.9/24.9KG



● 货号 (No.): 8166-2
规格 (Spec): 21X15X10cm
积木量 (Particles qty): 200g
装箱数 (QTY): 72pcs/3 inbox
外箱尺寸 (Meast): 90X45X73cm
毛/净重 (G./N.W): 27.9/24.9KG



● 货号 (No.): 8166-3
规格 (Spec): 21.5X15X11cm
积木量 (Particles qty): 200g
装箱数 (QTY): 72pcs/3 inbox
外箱尺寸 (Meast): 90X45X73cm
毛/净重 (G./N.W): 28.1/25.1KG



● 货号 (No.): 8165-8
规格 (Spec): 24.5X14.5X15cm
积木量 (Particles qty): 250g
装箱数 (QTY): 48pcs/2 inbox
外箱尺寸 (Meast): 88X57X57cm
毛/净重 (G./N.W): 22.3/19.3KG



● 货号 (No.): 8166-8
规格 (Spec): 24.5X14.5X15cm
积木量 (Particles qty): 350g
装箱数 (QTY): 48pcs/2 inbox
外箱尺寸 (Meast): 88X57X57cm
毛/净重 (G./N.W): 27.5/24.5KG



● 货号 (No.): 8323-1
规格 (Spec): 38X23X20.5cm
积木量 (Particles qty): 700g
装箱数 (QTY): 24pcs/2 inboxes
外箱尺寸 (Meast): 88X58X78cm
毛/净重 (G./N.W): 28/25KG



● 货号 (No.): 8323-2
规格 (Spec): 38X23X20.5cm
积木量 (Particles qty): 72PCS
装箱数 (QTY): 24pcs/2 inboxes
外箱尺寸 (Meast): 88X58X78cm
毛/净重 (G./N.W): 23.5/20.5KG



● 货号 (No.): 8323-5
规格 (Spec): 38X23X20.5cm
积木量 (Particles qty): 35PCS
装箱数 (QTY): 24pcs/2 inboxes
外箱尺寸 (Meast): 88X58X78cm
毛/净重 (G./N.W): 25/22KG



● 货号 (No.): 8322-1
规格 (Spec): 41X23.5X19cm
积木量 (Particles qty): 700g
装箱数 (QTY): 24pcs/2 inboxes
外箱尺寸 (Meast): 90X54X88cm
毛/净重 (G./N.W): 28.1/25.1KG



● 货号 (No.): 8322-2
规格 (Spec): 41X23.5X19cm
积木量 (Particles qty): 72PCS
装箱数 (QTY): 24pcs/2 inboxes
外箱尺寸 (Meast): 90X54X88cm
毛/净重 (G./N.W): 23.3/20.3KG



● 货号 (No.): 8322-5
规格 (Spec): 41X23.5X19cm
积木量 (Particles qty): 29PCS
装箱数 (QTY): 24pcs/2 inboxes
外箱尺寸 (Meast): 90X54X88cm
毛/净重 (G./N.W): 24.5/21.5KG



● 货号 (No.): 8322-6
规格 (Spec): 41X23.5X19cm
积木量 (Particles qty): 600g
装箱数 (QTY): 24pcs/2 inboxes
外箱尺寸 (Meast): 90X54X88cm
毛/净重 (G./N.W): 25.7/22.7KG



● 货号 (No.): 8323-6
规格 (Spec): 38X23X20.5cm
积木量 (Particles qty): 540g
装箱数 (QTY): 24pcs/2 inboxes
外箱尺寸 (Meast): 88X58X78cm
毛/净重 (G./N.W): 24.2/21.2KG



● 货号 (No.): 8326-1
规格 (Spec): 26X14.8X13.3cm
积木量 (Particles qty): 180g
装箱数 (QTY): 48pcs/2 inboxes
外箱尺寸 (Meast): 96X44X58cm
毛/净重 (G./N.W): 18.8/15.8KG



● 货号 (No.): 8326-3
规格 (Spec): 26X14.8X13.3cm
积木量 (Particles qty): 260g
装箱数 (QTY): 48pcs/2 inboxes
外箱尺寸 (Meast): 96X44X58cm
毛/净重 (G./N.W): 22.5/19.5KG



● 货号 (No.): 8321-1
规格 (Spec): 41X23.5X19cm
积木量 (Particles qty): 700g
装箱数 (QTY): 24pcs/2 inboxes
外箱尺寸 (Meast): 90X50X88cm
毛/净重 (G./N.W): 28.1/25.1KG



● 货号 (No.): 8321-2
规格 (Spec): 41X23.5X19cm
积木量 (Particles qty): 72PCS
装箱数 (QTY): 24pcs/2 inboxes
外箱尺寸 (Meast): 90X50X88cm
毛/净重 (G./N.W): 23.3/20.3KG



● 货号 (No.): 8321-5
规格 (Spec): 41X23.5X19cm
积木量 (Particles qty): 29PCS
装箱数 (QTY): 24pcs/2 inboxes
外箱尺寸 (Meast): 90X50X88cm
毛/净重 (G./N.W): 24.5/21.5KG



● 货号 (No.): 8321-6
规格 (Spec): 41X23.5X19cm
积木量 (Particles qty): 600g
装箱数 (QTY): 24pcs/2 inboxes
外箱尺寸 (Meast): 90X50X88cm
毛/净重 (G./N.W): 25.7/22.7KG



● 货号 (No.): 8326-6
规格 (Spec): 26X14.8X13.3cm
积木量 (Particles qty): 160g
装箱数 (QTY): 48pcs/2 inboxes
外箱尺寸 (Meast): 96X44X58cm
毛/净重 (G./N.W): 17.6/14.6KG



● 货号 (No.): 8310-2
规格 (Spec): 17X11.6X10cm
积木量 (Particles qty): 90g
装箱数 (QTY): 72pcs/2 inboxes
外箱尺寸 (Meast): 88X44X58cm
毛/净重 (G./N.W): 14.3/11.3KG



● 货号 (No.): 8310-3
规格 (Spec): 17X11.6X10cm
积木量 (Particles qty): 90g
装箱数 (QTY): 72pcs/2 inboxes
外箱尺寸 (Meast): 88X44X58cm
毛/净重 (G./N.W): 14.3/11.3KG



● 货号 (No.): 8310-6
规格 (Spec): 17X11.6X10cm
积木量 (Particles qty): 60g
装箱数 (QTY): 72pcs/2 inboxes
外箱尺寸 (Meast): 88X44X58cm
毛/净重 (G./N.W): 12.1/9.1KG



● 货号 (No.): 8312-1
规格 (Spec): 28X20X11cm
积木量 (Particles qty): 300g
装箱数 (QTY): 24pcs/2 inboxes
外箱尺寸 (Meast): 70X42X58cm
毛/净重 (G./N.W): 13.9/10.9KG



● 货号 (No.): 8315-2
规格 (Spec): 28X20X11cm
积木量 (Particles qty): 300g
装箱数 (QTY): 24pcs/2 inboxes
外箱尺寸 (Meast): 70X42X58cm
毛/净重 (G./N.W): 13.9/10.9KG



● 货号 (No.): 8313-6
规格 (Spec): 28X20X11cm
积木量 (Particles qty): 300g
装箱数 (QTY): 24pcs/2 inboxes
外箱尺寸 (Meast): 70X42X58cm
毛/净重 (G./N.W): 13.9/10.9KG

**FOOTBALL
SERIES**
足球系列



FOOTBALL SERIES
足球系列



● 货号 (No.): 1001
规格 (Spec): Φ : 18cm
积木量 (Particles qty): 200g
装箱数 (QTY): 48pcs/2 inbox
外箱尺寸 (Meast): 73X55X74cm
毛/净重 (G./N.W): 18.5/15KG



● 货号 (No.): 1001-2
规格 (Spec): Φ : 18cm
积木量 (Particles qty): 24pcs
装箱数 (QTY): 48pcs/2 inbox
外箱尺寸 (Meast): 73X55X74cm
毛/净重 (G./N.W): 17.5/14KG



● 货号 (No.): 1001-3
规格 (Spec): Φ : 18cm
积木量 (Particles qty): 300g
装箱数 (QTY): 48pcs/2 inbox
外箱尺寸 (Meast): 73X55X74cm
毛/净重 (G./N.W): 23.5/20KG



● 货号 (No.): 1001-6
规格 (Spec): Φ : 18cm
积木量 (Particles qty): 140g
装箱数 (QTY): 48pcs/2 inbox
外箱尺寸 (Meast): 73X55X74cm
毛/净重 (G./N.W): 16.5/13KG



● 货号 (No.): 1001B
规格 (Spec): Φ : 18cm
积木量 (Particles qty): 200g
装箱数 (QTY): 48pcs/2 inbox
外箱尺寸 (Meast): 73X55X74cm
毛/净重 (G./N.W): 18.5/15KG



● 货号 (No.): 1001B-2
规格 (Spec): Φ : 18cm
积木量 (Particles qty): 24pcs
装箱数 (QTY): 48pcs/2 inbox
外箱尺寸 (Meast): 73X55X74cm
毛/净重 (G./N.W): 17.5/14KG



● 货号 (No.): 1001B-3
规格 (Spec): Φ : 18cm
积木量 (Particles qty): 300g
装箱数 (QTY): 48pcs/2 inbox
外箱尺寸 (Meast): 73X55X74cm
毛/净重 (G./N.W): 23.5/20KG



● 货号 (No.): 1001B-6
规格 (Spec): Φ : 18cm
积木量 (Particles qty): 140g
装箱数 (QTY): 48pcs/2 inbox
外箱尺寸 (Meast): 73X55X74cm
毛/净重 (G./N.W): 16.5/13KG



● 货号 (No.): 8126-1
规格 (Spec): 14.5X14.5X36cm
积木量 (Particles qty): 250g
装箱数 (QTY): 36pcs/2 inbox
外箱尺寸 (Meast): 80X42X78cm
毛/净重 (G./N.W): 19.4/16.4KG



● 货号 (No.): 8126-2
规格 (Spec): 14.5X14.5X36cm
积木量 (Particles qty): 24pcs
装箱数 (QTY): 36pcs/2 inbox
外箱尺寸 (Meast): 80X42X78cm
毛/净重 (G./N.W): 17/14KG



● 货号 (No.): 8126-6
规格 (Spec): 14.5X14.5X36cm
积木量 (Particles qty): 200g
装箱数 (QTY): 36pcs/2 inbox
外箱尺寸 (Meast): 80X42X78cm
毛/净重 (G./N.W): 17.6/14.6KG



● 货号 (No.): 8126-3
规格 (Spec): 14.5X14.5X36cm
积木量 (Particles qty): 350g
装箱数 (QTY): 36pcs/2 inbox
外箱尺寸 (Meast): 80X42X78cm
毛/净重 (G./N.W): 23/20KG



● 货号 (No.): 8152-2
规格 (Spec): Φ : 22cm
积木量 (Particles qty): 48pcs
装箱数 (QTY): 24pcs/2 inbox
外箱尺寸 (Meast): 68X48X93cm
毛/净重 (G./N.W): 15.5/12.5KG



● 货号 (No.): 8152-5
规格 (Spec): Φ : 22cm
积木量 (Particles qty): 20pcs
装箱数 (QTY): 24pcs/2 inbox
外箱尺寸 (Meast): 68X48X93cm
毛/净重 (G./N.W): 15.5/12.5KG



● 货号 (No.): 8152-6
规格 (Spec): Φ : 22cm
积木量 (Particles qty): 350g
装箱数 (QTY): 24pcs/2 inbox
外箱尺寸 (Meast): 68X48X93cm
毛/净重 (G./N.W): 15.5/12.5KG



● 货号 (No.): 8152B-2
规格 (Spec): Φ : 22cm
积木量 (Particles qty): 48pcs
装箱数 (QTY): 24pcs/2 inbox
外箱尺寸 (Meast): 68X48X93cm
毛/净重 (G./N.W): 15.5/12.5KG



● 货号 (No.): 8152B-5
规格 (Spec): Φ : 22cm
积木量 (Particles qty): 20pcs
装箱数 (QTY): 24pcs/2 inbox
外箱尺寸 (Meast): 68X48X93cm
毛/净重 (G./N.W): 15.5/12.5KG



● 货号 (No.): 8152B-6
规格 (Spec): Φ : 22cm
积木量 (Particles qty): 350g
装箱数 (QTY): 24pcs/2 inbox
外箱尺寸 (Meast): 68X48X93cm
毛/净重 (G./N.W): 15.5/12.5KG

每一块乐乐兄弟积木都秉承

Every piece of LELE BROTHER building blocks are adhering to the belief

“只有做到最好才足够”

"TO MAKE IT THE BEST"

化学测试 Chemical testing

3C安全性食品安全级别
3C food safety standard

力学测试 Mechanics testing

咬合精密度达0.02mm
Occlusion precision reach to 0.02mm

利边测试 Sharp edge testing

防伤害无棱角设计
Anti damage no angular design

安全测试 Safety testing

产品0召回防吞咽窒息
Product 0 recall anti swallowing asphyxia

CANNED SERIES

罐装系列



CANNED SERIES

罐装系列



● 货号 (No.): 8135-1
规格 (Spec): 13X12X28cm
积木量 (Particles qty): 200g
装箱数 (QTY): 36pcs/2 inbox
外箱尺寸 (Meast): 80X43X62cm
毛/净重 (G./N.W): 16.9/13.9KG



● 货号 (No.): 8135-2
规格 (Spec): 13X12X28cm
积木量 (Particles qty): 22pcs
装箱数 (QTY): 36pcs/2 inbox
外箱尺寸 (Meast): 80X43X62cm
毛/净重 (G./N.W): 15.2/12.2KG



● 货号 (No.): 8135-3
规格 (Spec): 13X12X28cm
积木量 (Particles qty): 250g
装箱数 (QTY): 36pcs/2 inbox
外箱尺寸 (Meast): 80X43X62cm
毛/净重 (G./N.W): 18.7/15.7KG



● 货号 (No.): 8135-6
规格 (Spec): 13X12X28cm
积木量 (Particles qty): 160g
装箱数 (QTY): 36pcs/2 inbox
外箱尺寸 (Meast): 80X43X62cm
毛/净重 (G./N.W): 15.5/12.5KG



● 货号 (No.): 3118-2
规格 (Spec): 16X16X34cm
积木量 (Particles qty): 300g
装箱数 (QTY): 24pcs/2 inbox
外箱尺寸 (Meast): 62X46X70cm
毛/净重 (G./N.W): 15/13KG



● 货号 (No.): 2122
规格 (Spec): 16X16X34cm
积木量 (Particles qty): 36pcs
装箱数 (QTY): 24pcs/2 inbox
外箱尺寸 (Meast): 62X46X70cm
毛/净重 (G./N.W): 12/9.5KG



● 货号 (No.): 3118-1
规格 (Spec): 14X14X31cm
积木量 (Particles qty): 200g
装箱数 (QTY): 36pcs/3 inbox
外箱尺寸 (Meast): 53X39X93cm
毛/净重 (G./N.W): 14/12KG



● 货号 (No.): 8311-3
规格 (Spec): 21X23X14cm
积木量 (Particles qty): 250g
装箱数 (QTY): 24pcs/2 inbox
外箱尺寸 (Meast): 61X48X49cm
毛/净重 (G./N.W): 13.1/10.3KG



● 货号 (No.): 8311-1
规格 (Spec): 21X23X14cm
积木量 (Particles qty): 200g
装箱数 (QTY): 24pcs/2 inbox
外箱尺寸 (Meast): 61X48X49cm
毛/净重 (G./N.W): 12.2/9.2KG



● 货号 (No.): 8161-1
规格 (Spec): 18.3X15X17cm
积木量 (Particles qty): 250g
装箱数 (QTY): 48pcs/2 inbox
外箱尺寸 (Meast): 70X48X73cm
毛/净重 (G./N.W): 22.2/19.2KG



● 货号 (No.): 8161-2
规格 (Spec): 18.3X15X17cm
积木量 (Particles qty): 24pcs
装箱数 (QTY): 48pcs/2 inbox
外箱尺寸 (Meast): 70X48X73cm
毛/净重 (G./N.W): 18.9/15.9KG



● 货号 (No.): 8161-3
规格 (Spec): 18.3X15X17cm
积木量 (Particles qty): 350g
装箱数 (QTY): 48pcs/2 inbox
外箱尺寸 (Meast): 70X48X73cm
毛/净重 (G./N.W): 27/24KG



● 货号 (No.): 8161-6
规格 (Spec): 18.3X15X17cm
积木量 (Particles qty): 200g
装箱数 (QTY): 48pcs/2 inbox
外箱尺寸 (Meast): 70X48X73cm
毛/净重 (G./N.W): 20.2/17.2KG

BAG SERIES

袋装系列



BAG SERIES

袋装系列



● 货号 (No.): 162-1
规格 (Spec): 36X11X34cm
积木量 (Particles qty): 600g
装箱数 (QTY): 24pcs/2 inbox
外箱尺寸 (Meast): 79X40X85cm
毛/净重 (G./N.W): 21/19KG



● 货号 (No.): 162-2
规格 (Spec): 36X11X34cm
积木量 (Particles qty): 72pcs
装箱数 (QTY): 24pcs/2 inbox
外箱尺寸 (Meast): 79X40X85cm
毛/净重 (G./N.W): 17/14KG



● 货号 (No.): 162-5
规格 (Spec): 36X11X34cm
积木量 (Particles qty): 40pcs
装箱数 (QTY): 24pcs/2 inbox
外箱尺寸 (Meast): 79X40X85cm
毛/净重 (G./N.W): 20.5/17.5KG



● 货号 (No.): 162-6
规格 (Spec): 36X11X34cm
积木量 (Particles qty): 500g
装箱数 (QTY): 24pcs/2 inbox
外箱尺寸 (Meast): 79X40X85cm
毛/净重 (G./N.W): 19.5/16.5KG



● 货号 (No.): 3116-1
规格 (Spec): 36X29cm
积木量 (Particles qty): 400g
装箱数 (QTY): 48pcs/2 inbox
外箱尺寸 (Meast): 81X39X90cm
毛/净重 (G./N.W): 26/23KG



● 货号 (No.): 3116-2
规格 (Spec): 36X29cm
积木量 (Particles qty): 36pcs
装箱数 (QTY): 48pcs/2 inbox
外箱尺寸 (Meast): 81X39X90cm
毛/净重 (G./N.W): 19/16KG



● 货号 (No.): 3116-3
规格 (Spec): 36X29cm
积木量 (Particles qty): 450g
装箱数 (QTY): 48pcs/2 inbox
外箱尺寸 (Meast): 81X39X90cm
毛/净重 (G./N.W): 29.4/26.4KG



● 货号 (No.): 3116-5
规格 (Spec): 36X29cm
积木量 (Particles qty): 20pcs
装箱数 (QTY): 48pcs/2 inbox
外箱尺寸 (Meast): 81X39X90cm
毛/净重 (G./N.W): 22.5/19.5KG



● 货号 (No.): 3116-6
规格 (Spec): 36X29cm
积木量 (Particles qty): 300g
装箱数 (QTY): 48pcs/2 inbox
外箱尺寸 (Meast): 81X39X90cm
毛/净重 (G./N.W): 20.5/17.5KG



乐乐兄弟[®]
LELE BROTHER[®]

MY BLOCKS

LELE BROTHER MY BLOCKS WORLD

BLOCKS PRODUCT CATALOGUES

 **COPYRIGHT©LELE BROTHER**
 and its member companies, all right reserved.
 This books was published by the suport of kid 2016.

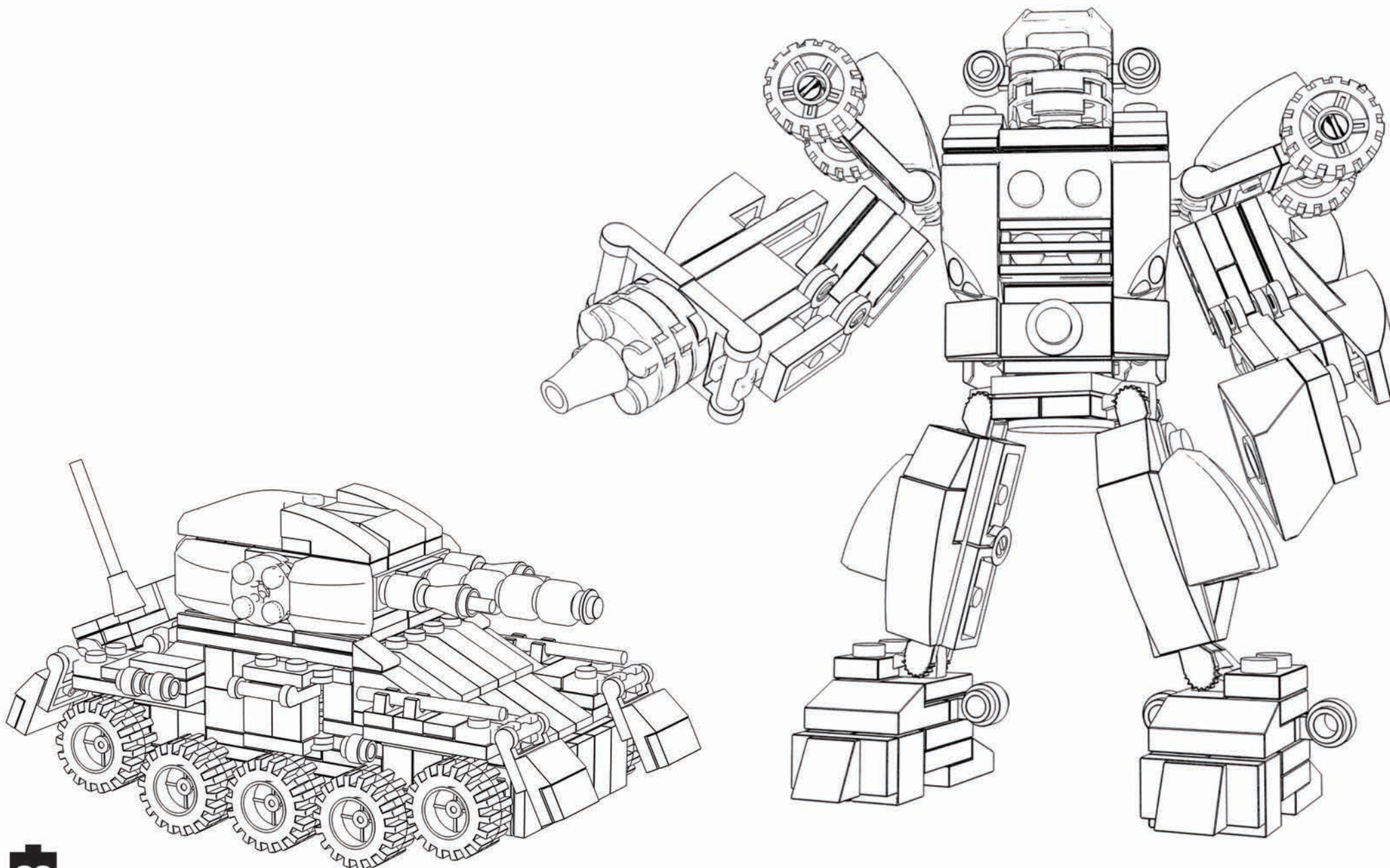

CONTENTS

- NEW** 战舰六合一系列 -----31
WARSHIP 6IN1 SERIES
- NEW** 变形战士系列1 -----33
DEFORMATION WARRIOR SERIES 1
- NEW** 变形战士系列2 -----35
DEFORMATION WARRIOR SERIES 2
- ▶ 坦克六合一系列 -----39
TANK 6IN1 SERIES
- ▶ 飞机六合1系列 -----41
FIGHTER 6IN1 SERIES
- ▶ 迷你三变系列 -----43
MINI THREE CHANGES SERIES
- ▶ 海盗船系列 -----45
PIRATE SHIP SERIES

乐高式积木
 Lego type building blocks



6IN1 THREE CHANGES
六款合一 单款三变

WARSHIP 6 IN 1 SERIES
战舰六合一系列



8508 (6款混装)
包装尺寸(SPEC):32.2*14.5*14.5CM
装箱量(QTY):24 DISPLAY
毛/净重(G./N.W):20/18.9KG



8508-1 (66PCS)
包装尺寸(SPEC):15.5*4.5*14CM
装箱量(QTY):144PCS/2 IN BOX
毛/净重(G./N.W):20/18.9KG

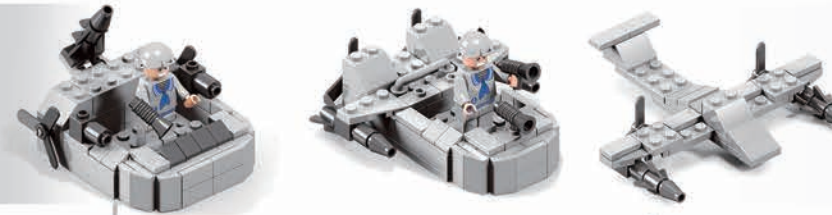

8508-2 (76PCS)
包装尺寸(SPEC):15.5*4.5*14CM
装箱量(QTY):144PCS/2 IN BOX
毛/净重(G./N.W):20/18.9KG



8508-3 (64PCS)
包装尺寸(SPEC):15.5*4.5*14CM
装箱量(QTY):144PCS/2 IN BOX
毛/净重(G./N.W):20/18.9KG



8508-4 (72PCS)
包装尺寸(SPEC):15.5*4.5*14CM
装箱量(QTY):144PCS/2 IN BOX
毛/净重(G./N.W):20/18.9KG

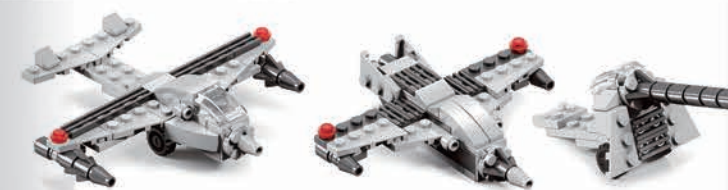

8508-5 (74PCS)
包装尺寸(SPEC):15.5*4.5*14CM
装箱量(QTY):144PCS/2 IN BOX
毛/净重(G./N.W):20/18.9KG

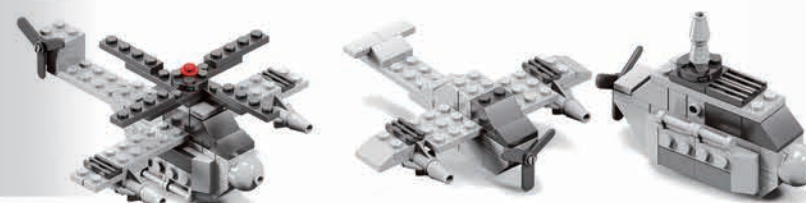

8508-6 (67PCS)
包装尺寸(SPEC):15.5*4.5*14CM
装箱量(QTY):144PCS/2 IN BOX
毛/净重(G./N.W):20/18.9KG



CREATOR

EGG package

8511 (3款12只混装)
 包装尺寸(SPEC):33*18.2*22.7CM
 装箱量(QTY):18 DISPLAY
 毛/净重(G./N.W):20.7/18.7KG



8511-1 (51PCS)

8511-2 (52PCS)



8511-3 (66PCS)



DEFORMATION WARRIOR SERIES
变形战士系列



8271 (142PCS)
包装尺寸(SPEC) : 26*19*4.5CM
装箱量(QTY) : 72PCS/2 IN BOX
毛/净重(G./N.W) : 15.4KG/12.4KG

DEFORMATION WARRIOR SERIES
变形战士系列



8276 (153PCS)
包装尺寸(SPEC) : 26*19*4.5CM
装箱量(QTY) : 72PCS/2 IN BOX
毛/净重(G./N.W) : 15.4KG/12.4KG



8272 (134PCS)
包装尺寸(SPEC) : 26*19*4.5CM
装箱量(QTY) : 72PCS/2 IN BOX
毛/净重(G./N.W) : 14.9KG/11.9KG

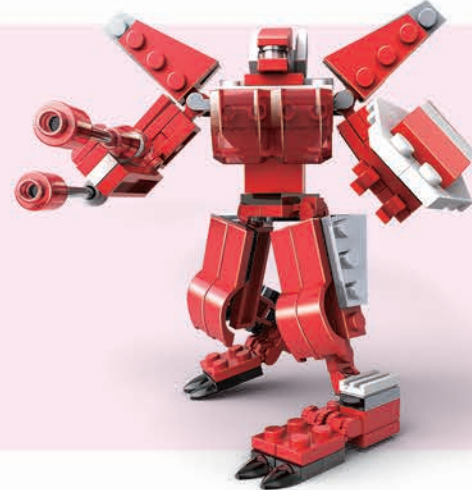
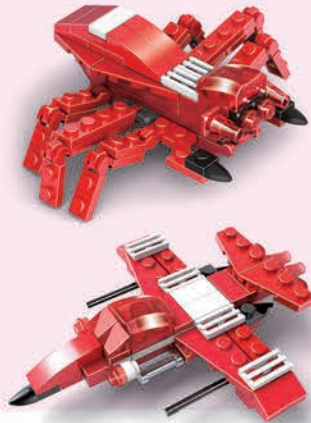

8277 (52PCS)
包装尺寸(SPEC) : 26*19*4.5CM
装箱量(QTY) : 72PCS/2 IN BOX
毛/净重(G./N.W) : 14.9KG/11.9KG



8273 (165PCS)
包装尺寸(SPEC) : 26*19*4.5CM
装箱量(QTY) : 72PCS/2 IN BOX
毛/净重(G./N.W) : 16.8KG/13.8KG



8278 (137PCS)
包装尺寸(SPEC) : 26*19*4.5CM
装箱量(QTY) : 72PCS/2 IN BOX
毛/净重(G./N.W) : 16.8KG/13.8KG



8275 (155PCS)
包装尺寸(SPEC) : 26*19*4.5CM
装箱量(QTY) : 72PCS/2 IN BOX
毛/净重(G./N.W) : 15.8KG/12.8KG

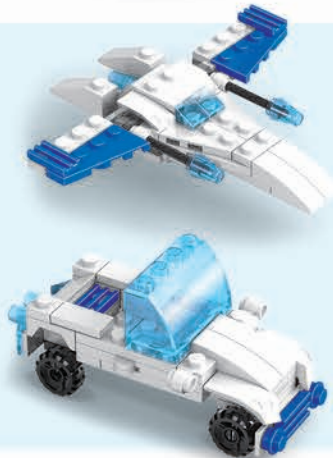

8279 (133PCS)
包装尺寸(SPEC) : 26*19*4.5CM
装箱量(QTY) : 72PCS/2 IN BOX
毛/净重(G./N.W) : 15.8KG/12.8KG



6IN1 THREE CHANGES
六款合一 单款三变

TANK 6 IN 1 SERIES
坦克六合一系列



6IN1 THREE CHANGES
六款合一 单款三变



8301 (6款混装)
包装尺寸(SPEC) : 30*12.5*14.5CM
装箱量(QTY) : 24 DISPLAY
毛/净重(G./N.W) : 18.4/17KG



8281 (71PCS)
包装尺寸(SPEC) : 14*12*4.5CM
装箱量(QTY) : 144PCS /2 IN BOX
毛/净重(G./N.W) : 18.4/17KG



8282 (68PCS)
包装尺寸(SPEC) : 14*12*4.5CM
装箱量(QTY) : 144PCS /2 IN BOX
毛/净重(G./N.W) : 18.4/17KG



8283 (78PCS)
包装尺寸(SPEC) : 14*12*4.5CM
装箱量(QTY) : 144PCS /2 IN BOX
毛/净重(G./N.W) : 18.4/17KG



8285 (81PCS)
包装尺寸(SPEC) : 14*12*4.5CM
装箱量(QTY) : 144PCS /2 IN BOX
毛/净重(G./N.W) : 18.4/17KG



8286 (83PCS)
包装尺寸(SPEC) : 14*12*4.5CM
装箱量(QTY) : 144PCS /2 IN BOX
毛/净重(G./N.W) : 18.4/17KG



8287 (75PCS)
包装尺寸(SPEC) : 14*12*4.5CM
装箱量(QTY) : 144PCS /2 IN BOX
毛/净重(G./N.W) : 18.4/17KG



6IN1 THREE CHANGES
六款合一 单款三变

6IN1 THREE CHANGES
六款合一 单款三变

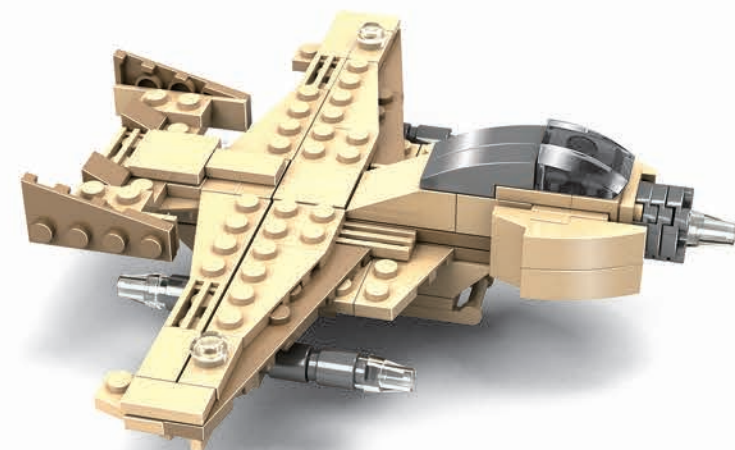

FIGHTER 6 IN 1 SERIES
飞机六合一系列



8299 (6款混装)
包装尺寸(SPEC) : 30*12.5*14.5CM
装箱量(QTY) : 24 DISPLAY
毛/净重(G./N.W) : 18.4/17KG

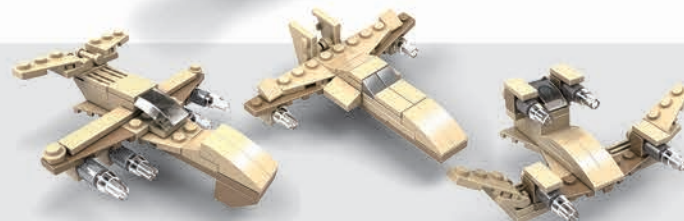

8288 (70PCS)
包装尺寸(SPEC) : 14*12*4.5CM
装箱量(QTY) : 144PCS /2 IN BOX
毛/净重(G./N.W) : 18.4/17KG



8289 (55PCS)
包装尺寸(SPEC) : 14*12*4.5CM
装箱量(QTY) : 144PCS /2 IN BOX
毛/净重(G./N.W) : 18.4/17KG

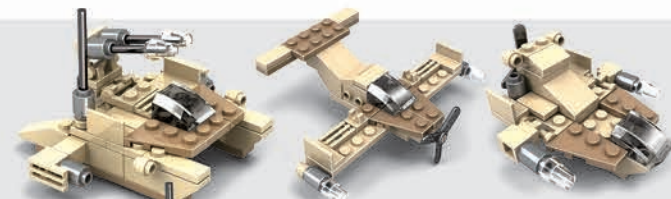

8291 (61PCS)
包装尺寸(SPEC) : 14*12*4.5CM
装箱量(QTY) : 144PCS /2 IN BOX
毛/净重(G./N.W) : 18.4/17KG



8292 (74PCS)
包装尺寸(SPEC) : 14*12*4.5CM
装箱量(QTY) : 144PCS /2 IN BOX
毛/净重(G./N.W) : 18.4/17KG



8293 (56PCS)
包装尺寸(SPEC) : 14*12*4.5CM
装箱量(QTY) : 144PCS /2 IN BOX
毛/净重(G./N.W) : 18.4/17KG



8295 (61PCS)
包装尺寸(SPEC) : 14*12*4.5CM
装箱量(QTY) : 144PCS /2 IN BOX
毛/净重(G./N.W) : 18.4/17KG



LELE BROTHER
MY BLOCKS WORLD

8506 (12款混装)
包装尺寸(SPEC): 29*19*7.2CM
小盒尺寸(SIZE): 9.2*7*4.5CM
装箱量(QTY): 48 DISPLAY
毛/净重(G./N.W): 28.1/25KG



LELE BROTHER
8506-1
29PCS

8506-1 (29PCS)



LELE BROTHER
8506-2
31PCS

8506-2 (31PCS)



LELE BROTHER
8506-3
38PCS

8506-3 (38PCS)



LELE BROTHER
8506-4
28PCS

8506-4 (28PCS)



LELE BROTHER
8506-5
32PCS

8506-5 (32PCS)



LELE BROTHER
8506-6
34PCS

8506-6 (34PCS)



LELE BROTHER
8506-7
37PCS

8506-7 (37PCS)



LELE BROTHER
8506-8
35PCS

8506-8 (35PCS)

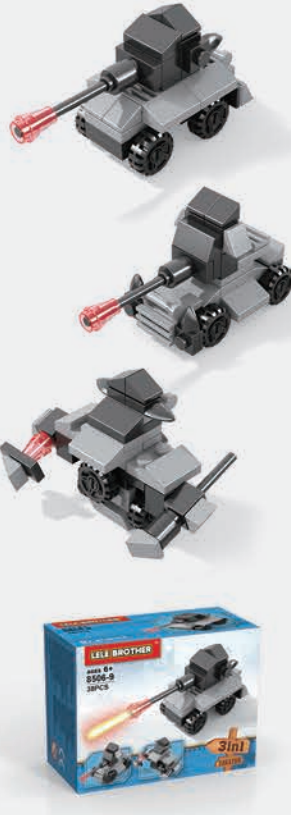

LELE BROTHER
8506-9
38PCS

8506-9 (38PCS)



LELE BROTHER
8506-10
43PCS

8506-10 (43PCS)



LELE BROTHER
8506-11
34PCS

8506-11 (34PCS)



LELE BROTHER
8506-12
23PCS

8506-12 (23PCS)



8502 (514PCS)
包装尺寸(SPEC): 32X32X6.5CM
装箱量(QTY): 36PCS
外箱尺寸(MEAST): 66X63X65CM
毛/净重(G/N.W): 20.3/17.7KG



8501 (526PCS)
包装尺寸(SPEC): 32X32X6.5CM
装箱量(QTY): 36PCS
外箱尺寸(MEAST): 66X63X65CM
毛/净重(G/N.W): 20.5/17.9KG



8505 (520PCS)
包装尺寸(SPEC): 32X32X6.5CM
装箱量(QTY): 36PCS
外箱尺寸(MEAST): 66X63X65CM
毛/净重(G/N.W): 19.6/17KG



8503 (580PCS)
包装尺寸(SPEC): 32X32X6.5CM
装箱量(QTY): 36PCS
外箱尺寸(MEAST): 66X63X65CM
毛/净重(G/N.W): 21.6/19KG





钻石积木

ABS diamond building blocks

WE START TO READ IT NOW....

01 ARCHITECTURE SERIES



6702 (1884PCS)
 难度系数: 5
 包装尺寸: 440X280X80MM
 装箱量: 12只/2内箱



158MM



6703 (2410PCS)
 难度系数: 5
 包装尺寸: 440X280X80MM
 装箱量: 12只/2内箱



173MM



02 MY BLOCKS



03/04

6261 (425PCS)

难度系数: ④④④④ 装箱量: 72只/2内箱
包装尺寸: 215X130X45MM毛 净重: 13.2/11.2KG

6260 (384PCS)

难度系数: ④④④④ 装箱量: 72只/2内箱
包装尺寸: 215X130X45MM毛 净重: 10.4/8.4KG

6285 (417PCS)

难度系数: ④④④④ 装箱量: 72只/2内箱
包装尺寸: 215X130X45MM毛 净重: 10.4/8.4KG



4 CARS AND GUYS



05

THE SERIES OF GUYS AND CARS



6215 (754PCS)
难度系数: ④④④④ 装箱量: 72只/2内箱
包装尺寸: 215X130X45MM毛 净重: 17.4/15.4KG

6216 (739PCS)
难度系数: ④④④④ 装箱量: 72只/2内箱
包装尺寸: 215X130X45MM毛 净重: 17/15KG

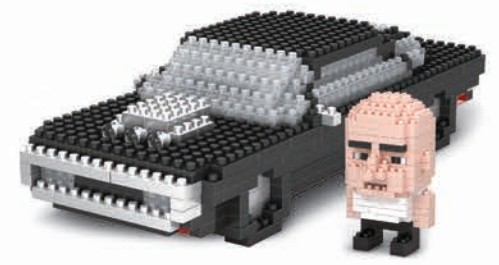

6218 (571PCS)
难度系数: ④④④④ 装箱量: 72只/2内箱
包装尺寸: 215X130X45MM毛 净重: 14.6/12.6KG

6219 (636PCS)
难度系数: ④④④④ 装箱量: 72只/2内箱
包装尺寸: 215X130X45MM毛 净重: 14.6/12.6KG



配置积木钳子
WITH SMALL BLOCKS PLIERS

6283 (725PCS)

难度系数: 4 装箱量: 72只/2内箱
包装尺寸: 210X130X45MM毛净重: 14.7/12.7KG



183MM

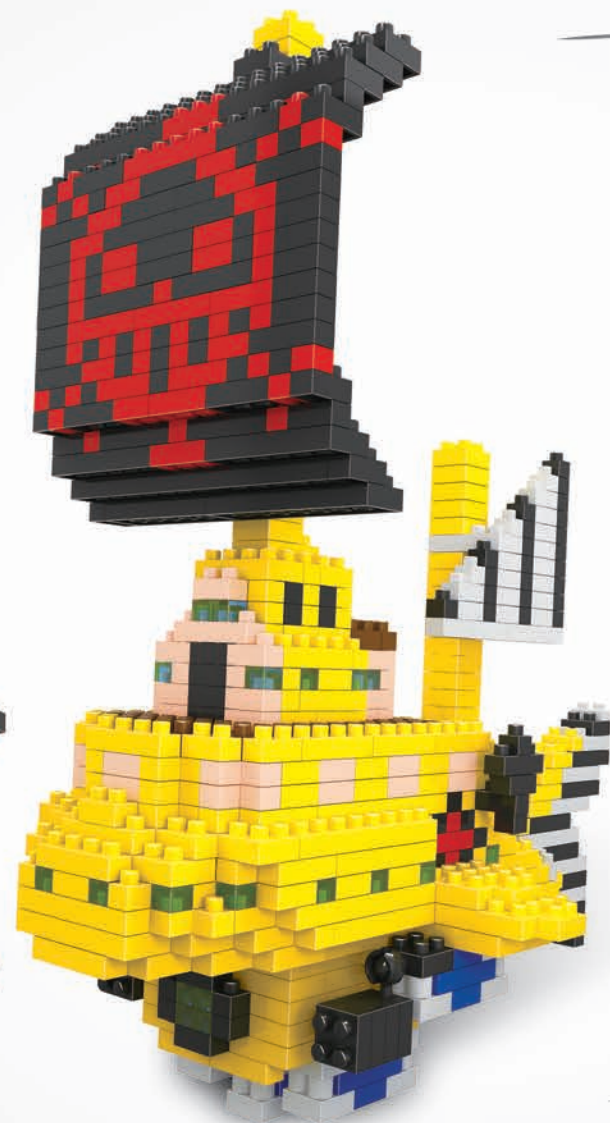

171MM

6282 (528PCS)

难度系数: 3 包装尺寸: 130X210X45MM

装箱量: 72只/2内箱
毛净重: 13.1/10.8KG

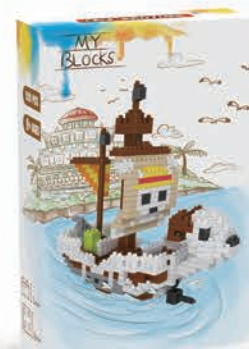

138MM

6228 (657PCS)

难度系数: 3 包装尺寸: 210X130X45MM

装箱量: 72只/2内箱
毛净重: 15.6/13.3KG



145MM

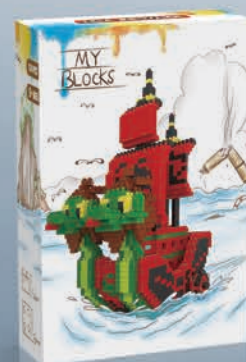

6281 (1174PCS)

难度系数: 4 装箱量: 72只/2内箱
包装尺寸: 210X130X45MM毛净重: 23.5/21.2KG

06

THE SERIES OF PIRATE SHIPS

COLORFUL/MINI SIZE/DIFFERENT LEVEL
HAND DRAWING STYLE BOX
FOR NINE YEARS OLD OR ABOVE

197MM

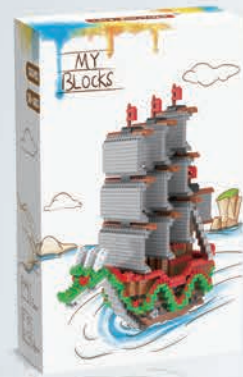

6701 (1335PCS)
难度系数: 5
包装尺寸: 165X230X65MM
装箱量: 72只/2内箱
毛净重: 34.7/31.1KG

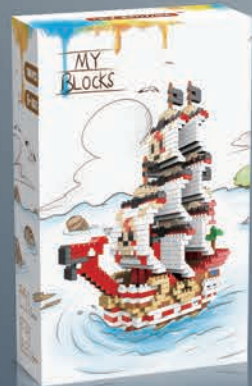

8268 (1086PCS)
难度系数: 5
包装尺寸: 165X230X65MM
装箱量: 72只/2内箱
毛净重: 28.7/25.1KG



179MM



176MM

8267 (1060PCS)
难度系数: 5
包装尺寸: 165X230X65MM
装箱量: 72只/2内箱
毛净重: 29.9/26.3KG



200MM

6700 (1245PCS)
难度系数: 5
包装尺寸: 165X230X65MM
装箱量: 72只/2内箱
毛净重: 34.2/30.6KG



191MM

8266 (1264PCS)
难度系数: 5
包装尺寸: 165X230X65MM
装箱量: 72只/2内箱
毛净重: 31.3/27.7KG

07

THE SERIES OF WARSHIP





积木展示盒 DISPLAY CASE

6159

包装尺寸: 210X140X45MM
装箱量: 72只/2内箱
毛净重: 12.6/10.6KG

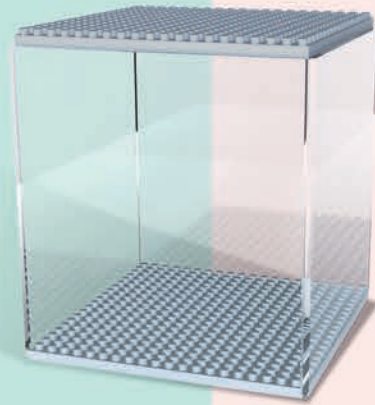

6161 (247PCS)

难度系数: 3 3 3 装箱量: 72只/2内箱
包装尺寸: 210X140X45MM毛净重: 16.8/14.8KG



6162 (254PCS)

难度系数: 3 3 3 装箱量: 72只/2内箱
包装尺寸: 210 X140X45MM毛净重: 17.6/15.6KG



6160 (224PCS)

难度系数: 3 3 3 装箱量: 72只/2内箱
包装尺寸: 210X140X45MM毛净重: 16.6/14.6KG



6195 (182PCS)

难度系数: 3 3 装箱量: 120只/2内箱
包装尺寸: 80X80X80MM毛净重: 6.0/4.0KG



6196 (141PCS)

难度系数: 3 3 装箱量: 120只/2内箱
包装尺寸: 80X80X80MM毛净重: 5.3/3.3KG



6198 (193PCS)

难度系数: 3 3 装箱量: 120只/2内箱
包装尺寸: 80X80X80MM毛净重: 6.0/4.0KG



6199 (192PCS)

难度系数: 3 3 装箱量: 120只/2内箱
包装尺寸: 80X80X80MM毛净重: 6.2/4.2KG



6210 (214PCS)

难度系数: 3 3 3 装箱量: 120只/2内箱
包装尺寸: 80X80X80MM毛净重: 5.8/3.8KG



6211 (243PCS)

难度系数: 3 3 3 装箱量: 120只/2内箱
包装尺寸: 80X80X80MM毛净重: 7.2/5.2KG



6212 (245PCS)

难度系数: 3 3 3 装箱量: 120只/2内箱
包装尺寸: 80X80X80MM毛净重: 6.4/4.4KG



08

THE SERIES OF
DISPLAY CASE

3合1 1/3 IN 1

卡通造型3合1+展示盒
CATOON STYLE 3 IN 1+ DISPLAY CASE

多色选择

MULTI-COLOR CHOOSE

积木展示盒多色选择, 颜色随机。
MULTI-COLOR BLOCKS DISPLAY CASE
CHOOSING,COLOR RANDOM

09

THE SERIES OF AGENTS
2合1



6251 (280PCS)

难度系数: 333 装箱量: 120只/2内箱
包装尺寸: 80X80X80MM 毛净重: 10.4/8.4KG

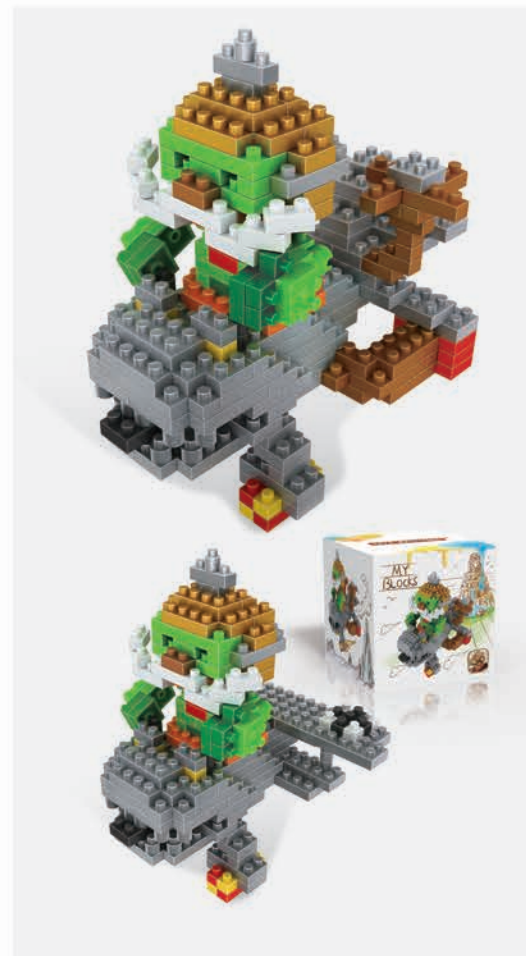

6253 (268PCS)

难度系数: 333 装箱量: 120只/2内箱
包装尺寸: 80X80X80MM 毛净重: 12.4/10.4KG



6259 (304PCS)

难度系数: 333 装箱量: 120只/2内箱
包装尺寸: 80X80X80MM 毛净重: 12.8/10.8KG



6255 (380PCS)

难度系数: 333 装箱量: 120只/2内箱
包装尺寸: 80X80X80MM 毛净重: 13.8/11.8KG

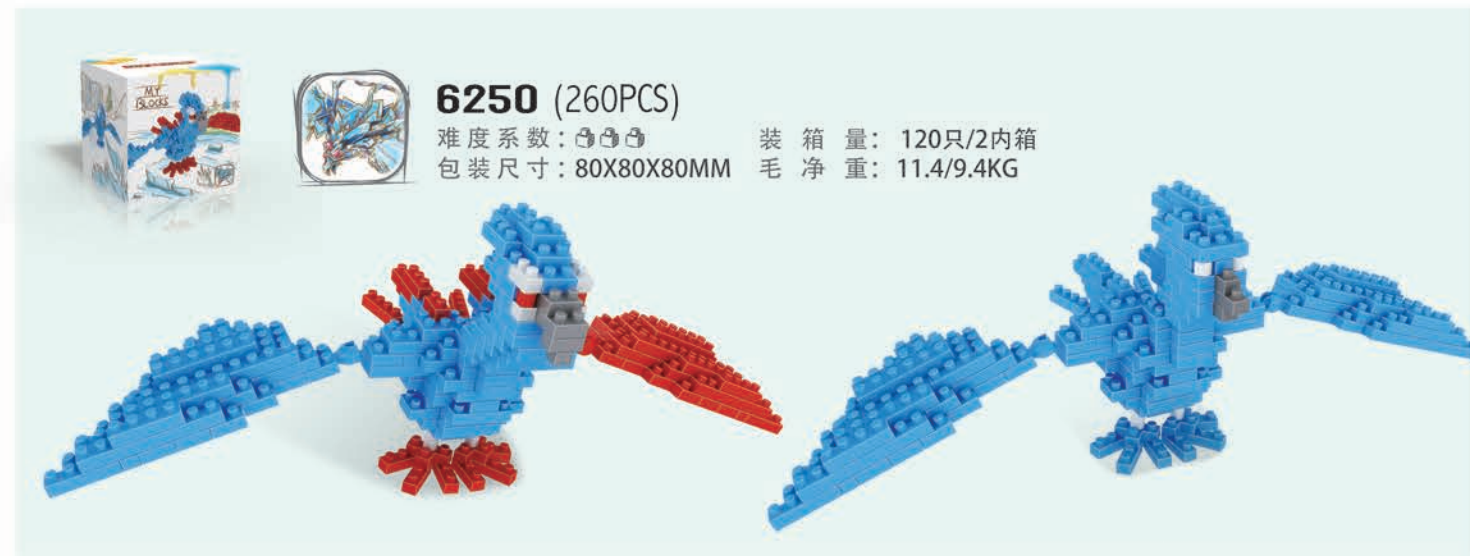

6250 (260PCS)

难度系数: 333 装箱量: 120只/2内箱
包装尺寸: 80X80X80MM 毛净重: 11.4/9.4KG



6258 (315PCS)

难度系数: 333 装箱量: 120只/2内箱
包装尺寸: 80X80X80MM 毛净重: 12.2/10.2KG



6252 (415PCS)

难度系数: 333 装箱量: 120只/2内箱
包装尺寸: 80X80X80MM 毛净重: 12.2/10.2KG



10

THE SERIES
OF WARRIOR
2合1

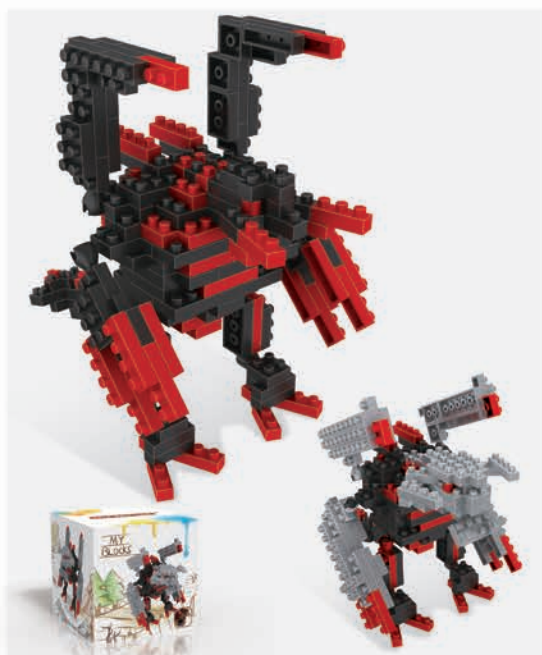

6256 (327PCS)

难度系数: 333 装箱量: 120只/2内箱
包装尺寸: 80X80X80MM 毛净重: 11.6/9.6KG



6220 (360PCS)
 难度系数: 3333
 装箱量: 120只/2内箱
 包装尺寸: 80X80X80MM 毛净重: 8.5/6.7KG



6222 (365PCS)
 难度系数: 3333
 装箱量: 120只/2内箱
 包装尺寸: 80X80X80MM 毛净重: 9.2/7.4KG



6192 (327PCS)
 难度系数: 3333
 装箱量: 120只/2内箱
 包装尺寸: 80X80X80MM 毛净重: 10/8KG

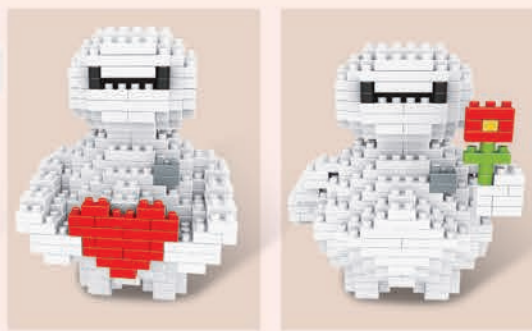

6221 (392PCS)
 难度系数: 3333
 装箱量: 120只/2内箱
 包装尺寸: 80X80X80MM 毛净重: 10.4/8.6KG



6193 (339PCS)
 难度系数: 3333
 装箱量: 120只/2内箱
 包装尺寸: 80X80X80MM 毛净重: 13.8/11.8KG

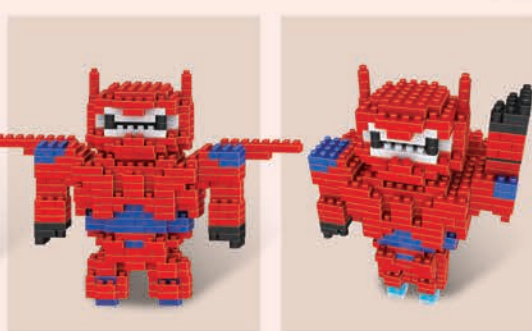

12 3合1 THE SERIES HERO

- COLORFUL/MINI SIZE
- DIFFERENT LEVEL
- HAND DRAWING STYLE BOX
- FOR NINE YEARS OLD OR ABOVE



11 3合1 OF USAVICH

6225 (346PCS)
 难度系数: 3333
 装箱量: 120只/2内箱
 包装尺寸: 80X80X80MM 毛净重: 7.5/5.8KG

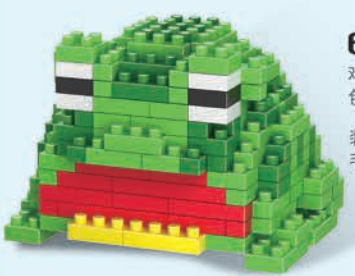

6223 (336PCS)
 难度系数: 3333
 装箱量: 120只/2内箱
 包装尺寸: 80X80X80MM 毛净重: 9.1/7.4KG

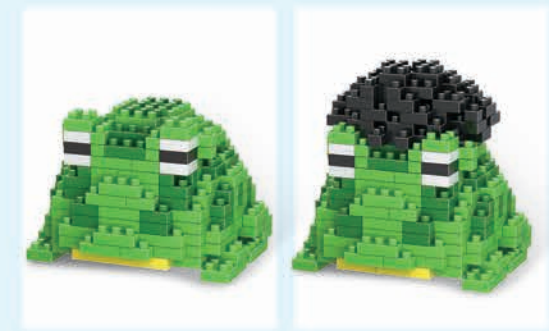

6226 (516PCS)
 难度系数: 3333
 装箱量: 120只/2内箱
 包装尺寸: 80X80X80MM 毛净重: 10.8/9KG



13

THE SERIES OF
PIRATES

3合1
造型多变



6138 (247PCS)

难度系数: 3
装箱量: 120只/2内箱
包装尺寸: 80X80X80MM 毛净重: 10.8KG

6151 (294PCS)

难度系数: 3
装箱量: 120只/2内箱
包装尺寸: 80X80X80MM 毛净重: 9.2/7.2KG

6163 (247PCS)

难度系数: 3
装箱量: 120只/2内箱
包装尺寸: 80X80X80MM 毛净重: 10.6/8.6KG

6165 (204PCS)

难度系数: 3
装箱量: 120只/2内箱
包装尺寸: 80X80X80MM 毛净重: 10.2/8.2KG

6166 (291PCS)

难度系数: 3
装箱量: 120只/2内箱
包装尺寸: 80X80X80MM 毛净重: 12.2/10.2KG

6168 (231PCS)

难度系数: 3
装箱量: 120只/2内箱
包装尺寸: 80X80X80MM 毛净重: 10.4/8.4KG

6169 (185PCS)

难度系数: 3
装箱量: 120只/2内箱
包装尺寸: 80X80X80MM 毛净重: 9.8/7.8KG

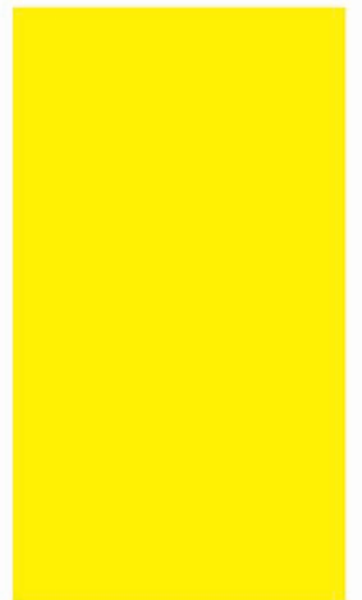
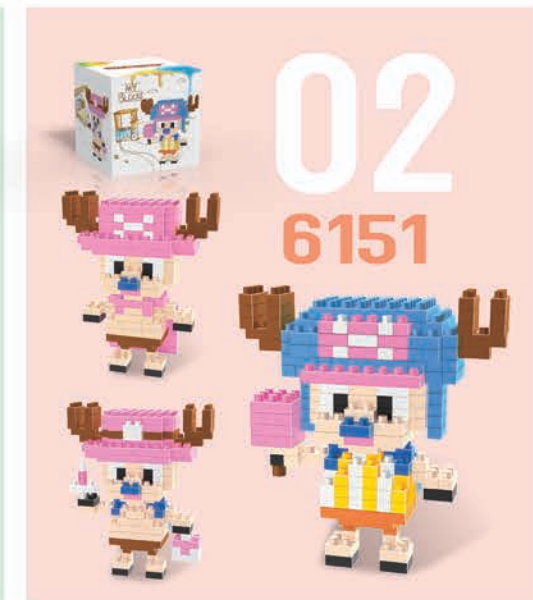



08
6295

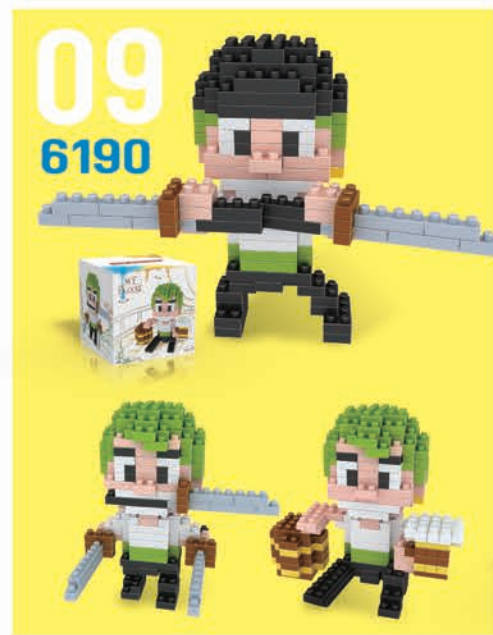

09
6190



10
6191

6295 (483PCS)
难度系数: 333
装箱量: 120只/2内箱
包装尺寸: 80X80X80MM 毛净重: 16/14KG

6190 (308PCS)
难度系数: 3333
装箱量: 120只/2内箱
包装尺寸: 80X80X80MM 毛净重: 11.6/9.6KG

6191 (233PCS)
难度系数: 333
装箱量: 120只/2内箱
包装尺寸: 80X80X80MM 毛净重: 10.2/8.2KG

6298 (465PCS)
难度系数: 3333
装箱量: 120只/2内箱
包装尺寸: 80X80X80MM 毛净重: 16.8/14.8KG



11
6298



12
6298



13
6298

6293 (417PCS)
难度系数: 333
装箱量: 120只/2内箱
包装尺寸: 80X80X80MM 毛净重: 15.5/13.5KG

6296 (255PCS)
难度系数: 333
装箱量: 120只/2内箱
包装尺寸: 80X80X80MM 毛净重: 11.5/9.5KG



8239 (723PCS)
难度系数: 333333
包装尺寸: 230X165X65MM
装箱量: 72只/2内箱
毛净重: 19.5/15.9KG



8269 (776PCS)
难度系数: 333333
包装尺寸: 230X165X65MM
装箱量: 72只/2内箱
毛净重: 21.7/18.1KG

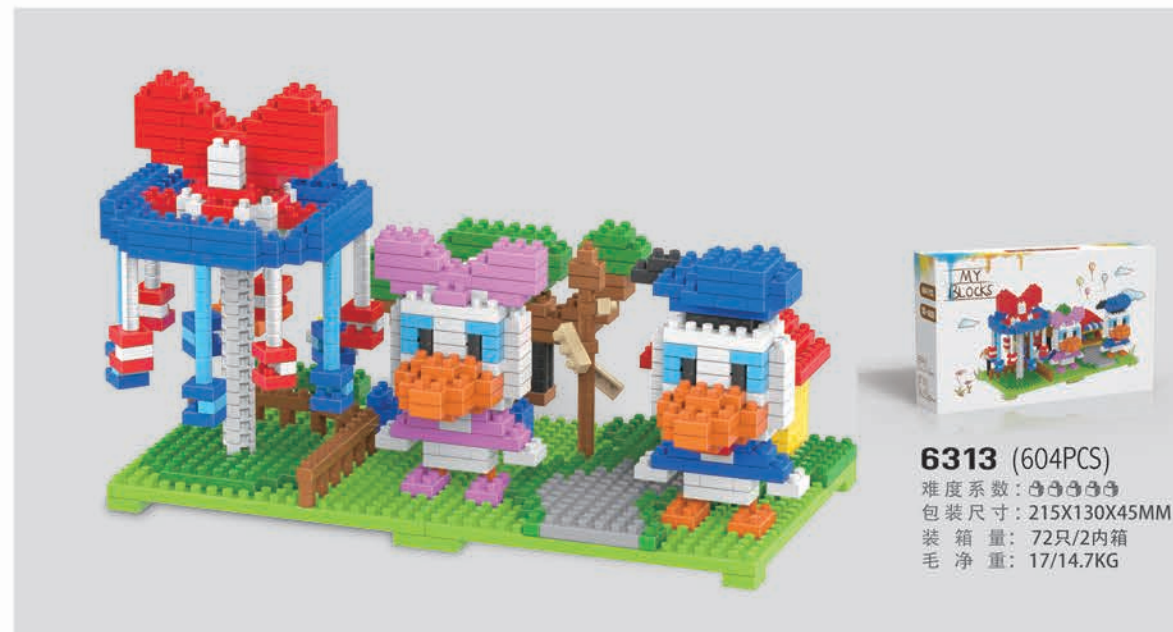

6313 (604PCS)
难度系数: 333333
包装尺寸: 215X130X45MM
装箱量: 72只/2内箱
毛净重: 17/14.7KG

14

AMUSEMENT PARK

15

PET SHOP & ICE-CREAM STORE



6315 (675PCS)
 难度系数: 33333
 包装尺寸: 215X130X45MM
 装箱量: 72只/2内箱
 毛净重: 17.5/14.9KG

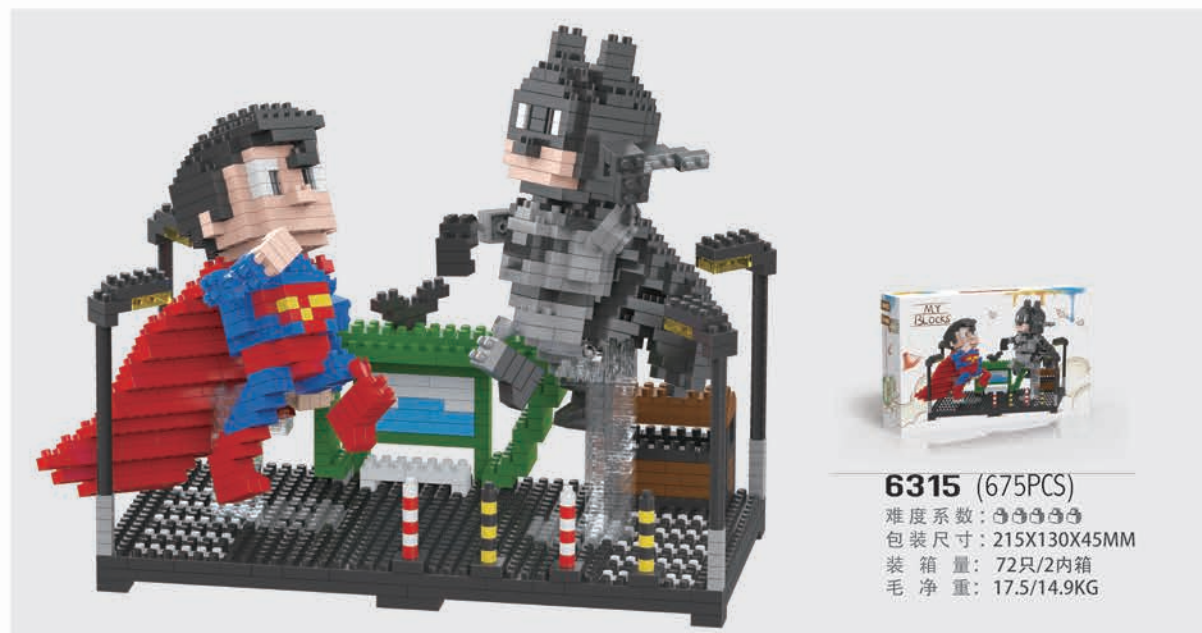

6315 (675PCS)
 难度系数: 33333
 包装尺寸: 215X130X45MM
 装箱量: 72只/2内箱
 毛净重: 17.5/14.9KG



8215 (780PCS)
 难度系数: 33333
 包装尺寸: 230X165X65MM
 装箱量: 72只/2内箱
 毛净重: 20.3/16.4KG



6293 (417PCS)
 难度系数: 333
 装箱量: 120只/2内箱
 包装尺寸: 80X80X80MM 毛净重: 15.5/13.5KG



6293 (417PCS)
 难度系数: 333
 装箱量: 120只/2内箱
 包装尺寸: 80X80X80MM 毛净重: 15.5/13.5KG

16

1 MODEL
POP CARTOON



8213 (602PCS)
 难度系数: 33333
 包装尺寸: 230X165X65MM
 装箱量: 72只/2内箱
 毛净重: 22.7/19.1KG

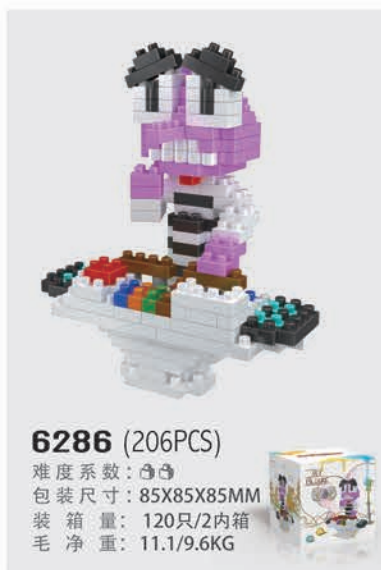

6286 (206PCS)
 难度系数: 33
 包装尺寸: 85X85X85MM
 装箱量: 120只/2内箱
 毛净重: 11.1/9.6KG

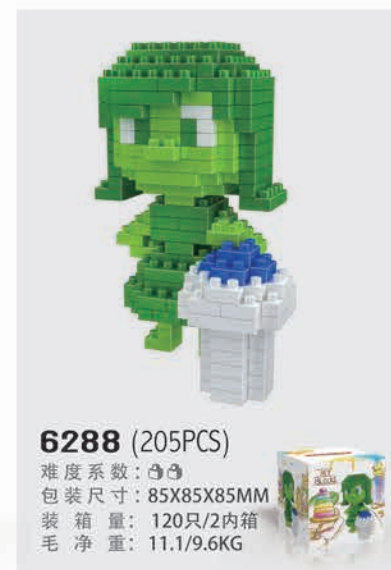

6288 (205PCS)
 难度系数: 33
 包装尺寸: 85X85X85MM
 装箱量: 120只/2内箱
 毛净重: 11.1/9.6KG

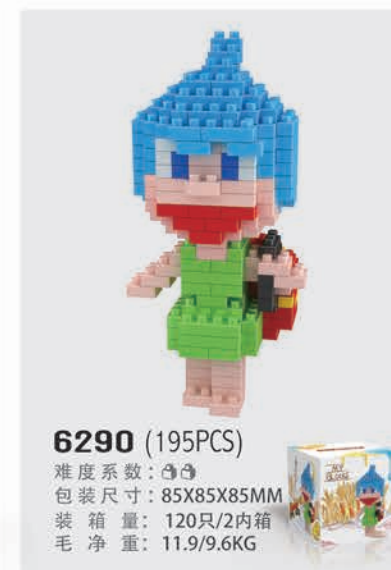

6290 (195PCS)
 难度系数: 33
 包装尺寸: 85X85X85MM
 装箱量: 120只/2内箱
 毛净重: 11.9/9.6KG



8253 (444PCS)
 难度系数: 3333
 包装尺寸: 85X85X85MM
 装箱量: 120只/2内箱
 毛净重: 13.7/11.7KG



8251 (351PCS)
 难度系数: 3333
 包装尺寸: 85X85X85MM
 装箱量: 120只/2内箱
 毛净重: 13.7/11.7KG



8233 (363PCS)
 难度系数: 3333
 包装尺寸: 85X85X85MM
 装箱量: 120只/2内箱
 毛净重: 13.1/11.1KG



8235 (247PCS)
 难度系数: 3333
 包装尺寸: 85X85X85MM
 装箱量: 120只/2内箱
 毛净重: 12.8/10.8KG



8255 (380PCS)
 难度系数: 3333
 包装尺寸: 85X85X85MM
 装箱量: 120只/2内箱
 毛净重: 14.1/12.1KG



8256 (383PCS)
 难度系数: 3333
 包装尺寸: 85X85X85MM
 装箱量: 120只/2内箱
 毛净重: 13.3/11.3KG



8237 (286PCS)
 难度系数: 3333
 包装尺寸: 85X85X85MM
 装箱量: 120只/2内箱
 毛净重: 12.2/10.2KG



8236 (242PCS)
 难度系数: 3333
 包装尺寸: 85X85X85MM
 装箱量: 120只/2内箱
 毛净重: 11.9/9.9KG



8252 (456PCS)
 难度系数: 3333
 包装尺寸: 85X85X85MM
 装箱量: 120只/2内箱
 毛净重: 16/14KG



8232 (379PCS)
 难度系数: 3333
 包装尺寸: 85X85X85MM
 装箱量: 120只/2内箱
 毛净重: 13.9/11.9KG

COLORFUL/MINI SIZE
HAND DRAWING
STYLE BOX
FOR NINE YEARS OLD
OR ABOVE



6115 (282PCS)
 难度系数: 3333 装箱量: 120只/2内箱
 包装尺寸: 80X80X80MM 毛净重: 10/8KG

6116 (362PCS)
 难度系数: 3333 装箱量: 120只/2内箱
 包装尺寸: 80X80X80MM 毛净重: 12.2/10.2KG

6119 (246PCS)
 难度系数: 3333 装箱量: 120只/2内箱
 包装尺寸: 80X80X80MM 毛净重: 9.6/7.6KG



6115



6116

3合1
 造型多变

17
 THE SERIES OF
 CARTOON



6119



6122



6123

6122 (224PCS)
 难度系数: 3333 装箱量: 120只/2内箱
 包装尺寸: 80X80X80MM 毛净重: 10.6/8.6KG

6118 (179PCS)
 难度系数: 3333 装箱量: 120只/2内箱
 包装尺寸: 80X80X80MM 毛净重: 8.6/6.6KG

6123 (255PCS)
 难度系数: 3333 装箱量: 120只/2内箱
 包装尺寸: 80X80X80MM 毛净重: 10.6/8.6KG



6118



6129

6129 (270PCS)
 难度系数: 333
 装箱量: 120只/2内箱
 包装尺寸: 80X80X80MM 毛净重: 9.2/7.2KG

6125 (161PCS)
 难度系数: 33
 装箱量: 120只/2内箱
 包装尺寸: 80X80X80MM 毛净重: 8.2/6.2KG

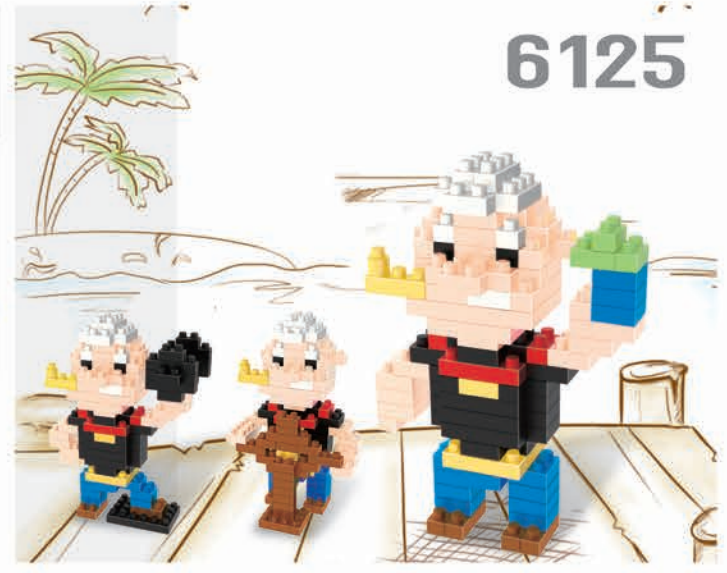

6125



6133

CARTOON

6133 (247PCS)
 难度系数: 333
 装箱量: 120只/2内箱
 包装尺寸: 80X80X80MM 毛净重: 8.6/6.6KG

6136 (235PCS)
 难度系数: 333
 装箱量: 120只/2内箱
 包装尺寸: 80X80X80MM 毛净重: 9.2/7.2KG



6126

3 IN 1

20 BLOCKS
60 POSE

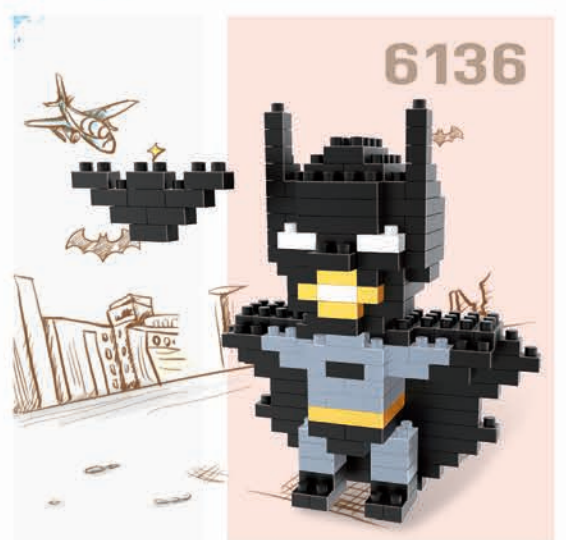

6136

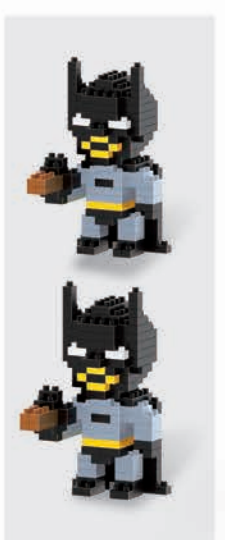

3 IN 1

20 BLOCKS
60 POSE



6128



6126 (222PCS)
 难度系数: 333
 装箱量: 120只/2内箱
 包装尺寸: 80X80X80MM 毛净重: 11.2/9.2KG

6128 (246PCS)
 难度系数: 333
 装箱量: 120只/2内箱
 包装尺寸: 80X80X80MM 毛净重: 9.8/7.8KG

6131 (214PCS)
 难度系数: 333
 装箱量: 120只/2内箱
 包装尺寸: 80X80X80MM 毛净重: 8.2/6.2KG

6132 (224PCS)
 难度系数: 333
 装箱量: 120只/2内箱
 包装尺寸: 80X80X80MM 毛净重: 9.6/7.6KG



6139



6139 (251PCS)
 难度系数: 3333
 装箱量: 120只/2内箱
 包装尺寸: 80X80X80MM 毛净重: 5.7/4.2KG

6152 (266PCS)
 难度系数: 3333
 装箱量: 120只/2内箱
 包装尺寸: 80X80X80MM 毛净重: 4.5/3KG



6131



6132



6152

18 THE SERIES OF ANIMALS AND INSTRUMENT



8115 (92PCS)
 难度系数: 3
 包装尺寸: 65X65X65MM
 装箱量: 96只/2内箱
 毛净重: 3.1/1.9KG



6153 (250PCS)
 难度系数: 3
 装箱量: 120只/2内箱
 包装尺寸: 80X80X80MM 毛净重: 7.8/5.8KG



6155 (264PCS)
 难度系数: 3
 装箱量: 120只/2内箱
 包装尺寸: 80X80X80MM 毛净重: 7.2/5.2KG

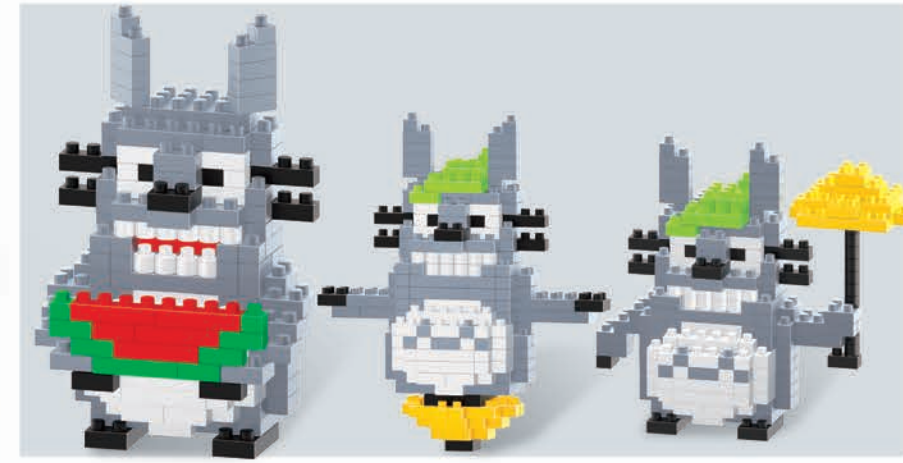

6156 (292PCS)
 难度系数: 3
 装箱量: 120只/2内箱
 包装尺寸: 80X80X80MM 毛净重: 8.4/6.4KG



6158 (205PCS)
 难度系数: 3
 装箱量: 120只/2内箱
 包装尺寸: 80X80X80MM 毛净重: 6/4KG



8111 (149PCS)
 难度系数: 3
 包装尺寸: 65X65X65MM
 装箱量: 96只/2内箱
 毛净重: 3.6/2.4KG



8113 (133PCS)
 难度系数: 3
 包装尺寸: 65X65X65MM
 装箱量: 96只/2内箱
 毛净重: 3.5/2.3KG



8136 (181PCS)
 难度系数: 3
 包装尺寸: 65X65X65MM
 装箱量: 96只/2内箱
 毛净重: 3.5/2.3KG



8138 (127PCS)
 难度系数: 3
 包装尺寸: 65X65X65MM
 装箱量: 96只/2内箱
 毛净重: 2.5/1.3KG



8151 (127PCS)
 难度系数: 3
 包装尺寸: 65X65X65MM
 装箱量: 96只/2内箱
 毛净重: 3.8/2.6KG



8153 (137PCS)
 难度系数: 3
 包装尺寸: 65X65X65MM
 装箱量: 96只/2内箱
 毛净重: 3.5/2.3KG



8155 (198PCS)
 难度系数: 3
 包装尺寸: 65X65X65MM
 装箱量: 96只/2内箱
 毛净重: 3.7/2.5KG



8156 (105PCS)
 难度系数: 3
 包装尺寸: 65X65X65MM
 装箱量: 96只/2内箱
 毛净重: 3.6/2.4KG

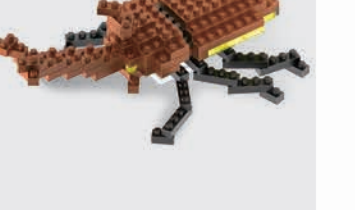



8158



8159

8158 (142PCS)
 难度系数: ③③ 装箱量: 96只/2内箱
 包装尺寸: 65X65X65MM 毛净重: 3.6/2.4KG

8159 (79PCS)
 难度系数: ③ 装箱量: 96只/2内箱
 包装尺寸: 65X65X65MM 毛净重: 2.6/1.4KG

8163 (94PCS)
 难度系数: ③ 装箱量: 96只/2内箱
 包装尺寸: 65X65X65MM 毛净重: 2.7/1.5KG

8168 (141PCS)
 难度系数: ③③ 装箱量: 96只/2内箱
 包装尺寸: 65X65X65MM 毛净重: 3.5/2.3KG

8189 (115PCS)
 难度系数: ③③ 装箱量: 96只/2内箱
 包装尺寸: 65X65X65MM 毛净重: 3.2/2KG



8168



8169



8190

8169 (82PCS)
 难度系数: ③ 装箱量: 96只/2内箱
 包装尺寸: 65X65X65MM 毛净重: 2.5/1.3KG

8190 (108PCS)
 难度系数: ③③ 装箱量: 96只/2内箱
 包装尺寸: 65X65X65MM 毛净重: 3.3/2.1KG



8163



8189

8298

包装尺寸: 90X90X110MM

装箱量: 48只/2内箱

毛净重: 7.3/4.6KG



19 THE
 SERIES OF
 MONEY BOX

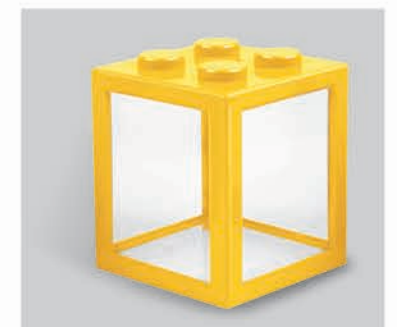
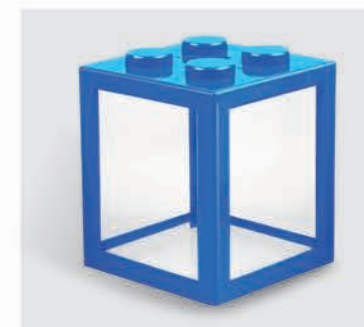
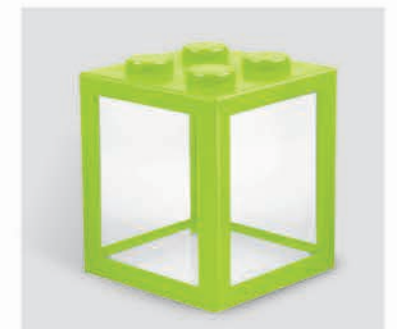
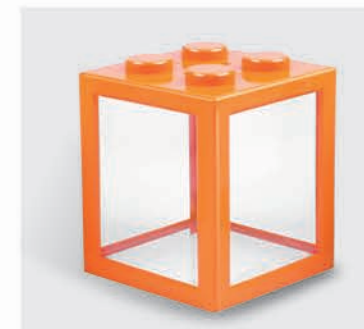



全方位提升宝宝五大能力

All-round enhance baby five ability

独有科学拼搭体系，配合成长阶段，开启非凡智慧！
Unique scientific building system, coordinate with growth stage, open the extraordinary wisdom!



思考能力 Thinking ability

一切从为什么开始，提高儿童的逻辑思维能力和智慧，以满足儿童的好奇心。
Everything begins from "why", improve children's logical thinking ability and intelligence, to satisfy children's curiosity.



运动能力 Exercise ability

通过手指的细微的动作，锻炼手眼协调能力。
Through fingers slight movement, exercise children's hand-eye coordination.



语言能力 Language ability

诱发儿童的发音及加强他们的语言能力，增强儿童对颜色及节奏感的理解。
Induce children's pronunciation and reinforce their language ability, enhance children's comprehension for color and rhythm.



“外观与感觉”能力 “Look and feel” ability

激发儿童的视觉，听觉，触觉的能力。
Motivate children's sense of sight, hearing and touch ability



专业积木玩具设计开发生产于一体的工厂

Professional building block toys factory integrated with the ability to design, develop and produce.

汕头市澄海区乐乐兄弟品牌是乐乐兄弟玩具有限公司其中一个品牌，专业积木玩具设计开发生产于一体的公司，致力于打造专业、安全的积木玩具品牌。

"LELE BROTHER" is one of the brand for SHANTOU CHENGHAI LELE BROTHER TOYS LIMITED, it's a professional building block toys company which integrated with the ability to design, develop and produce, devotes in making a professional and safety building block toys brand.

