

## 庆元博安电机有限公司

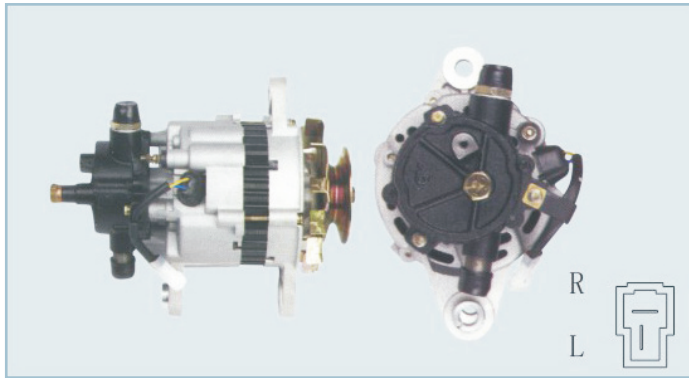

### JFZB2301 (24V 35A)

OEM:ME017552 A5T70183 ME017550

ENGINE:4D30 4D31

APPLICATION: (MITSUBISHI TRUCKS) CANTER BE BG FB FE FG

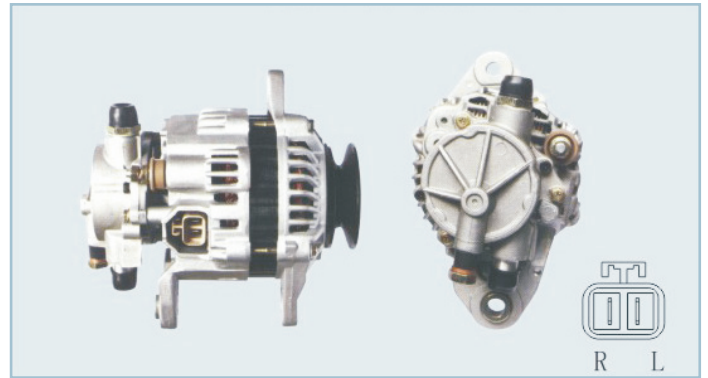

### JFZB2302 (24V 35A)

OEM:ME014669

ENGINE:4D34

APPLICATION:MITSUBISHI CANTER

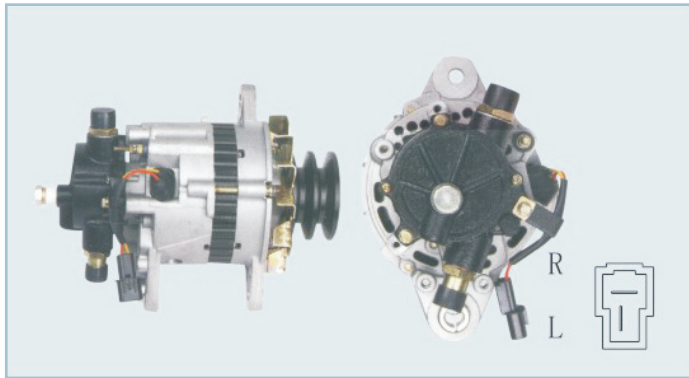

### JFZB2303 (24V 35A)

OEM:A2T01683 A2T01583

ENGINE:6D14 6D16

APPLICATION: (MITSUBISHI TRUCKS) CANTER FK115 116 335 245 337 415 515 517 615, FM215

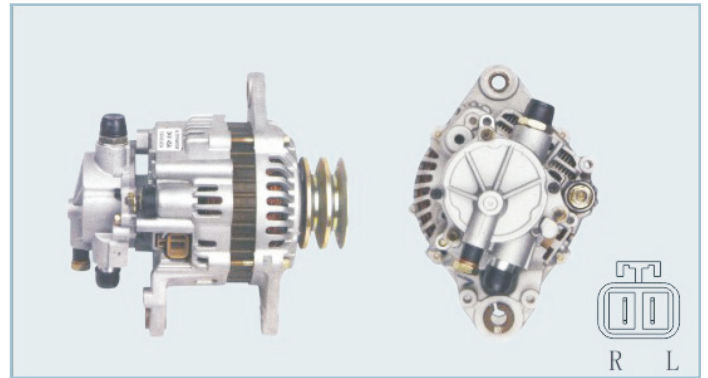

### JFZB2401 (24V 45A)

OEM:A3TN6188ZJ ME011698

ENGINE:4D34 4D34T

APPLICATION:MITSUBISHI CANTER FE439 FE449

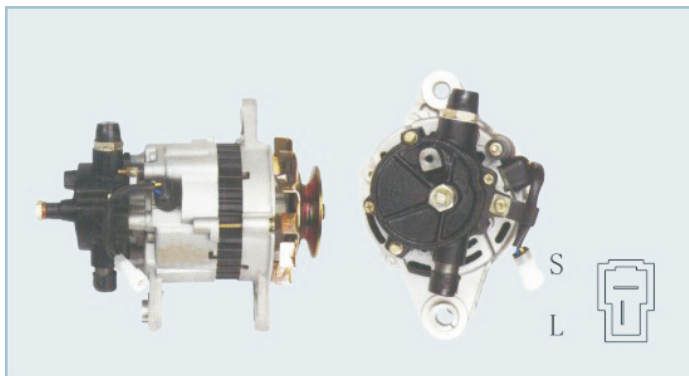

### JFZB1502 (12V 50A)

OEM:A3TN6188ZJ ME011698

ENGINE:4D34 4D34T

APPLICATION:MITSUBISHI CANTER FE439 FE449

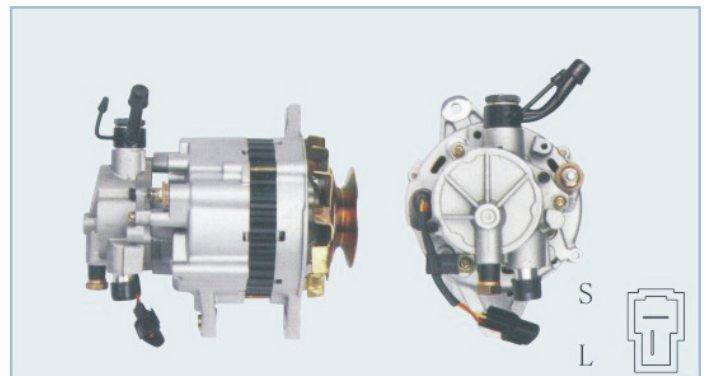

### JFZB1655A (12V 65A)

OEM:A2T01583 A2T01683 A2T01483

ENGINE:4D55

APPLICATION:MITSUBISHI L300 2.5D PAJERO 2.5TD SHOGUN 2.5D

## 庆元博安电机有限公司

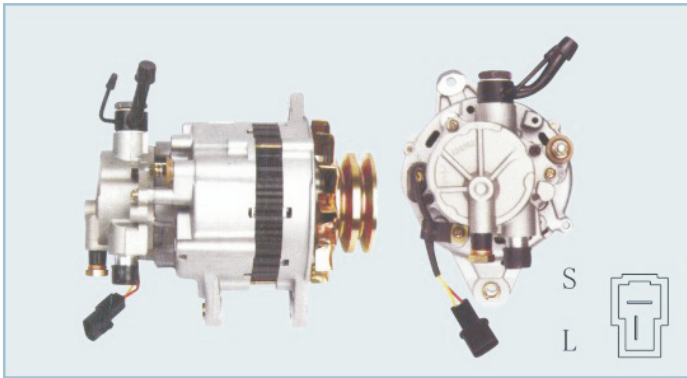
**JFZB1655B**(12V65A)

OEM:37300-42621 37300-42620 37300-47451

ENGINE:D4BX D4BB

APPLICATION:HYUNDAI TRUCKS 1 1.25TON PORTER

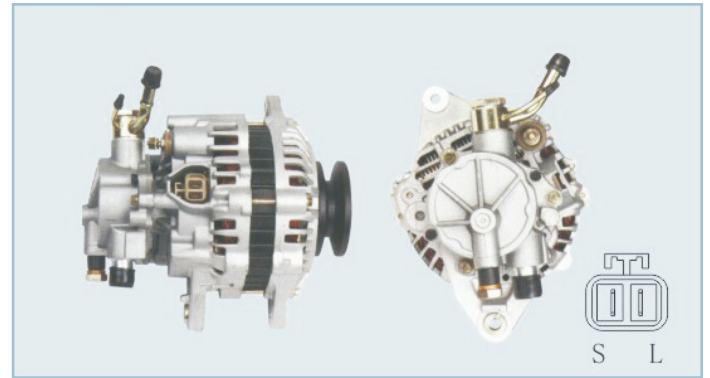
**JFZB1721A**(12V 75A)

OEM:A2TN2384ZJ

ENGINE:4D55 4D56

APPLICATION:MITSUBISHI

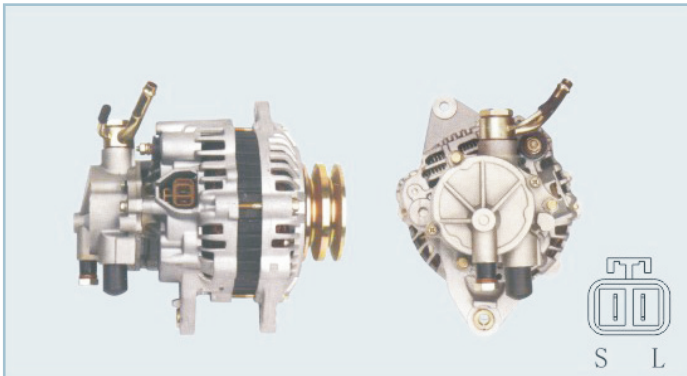
**JFZB1721B**(12V75A)

OEM:A2TN2299ZJ

ENGINE:4D55 4D56

APPLICATION:MITSUBISHI

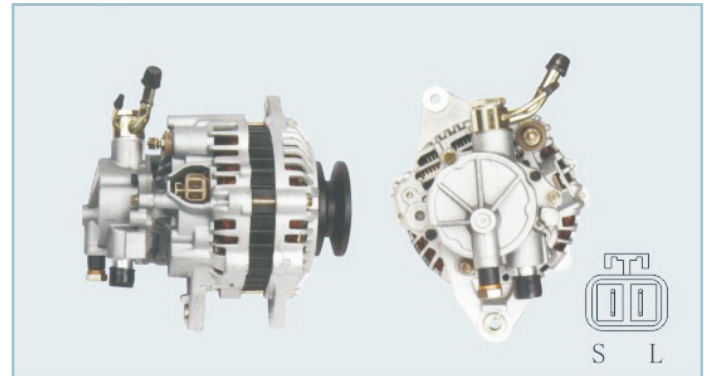
**JFZB1921A**(12V 110A)

OEM:23718 A3T07483 A3TN1578

ENGINE:4D56

APPLICATION:MITSUBISHI DELICA PAJERO

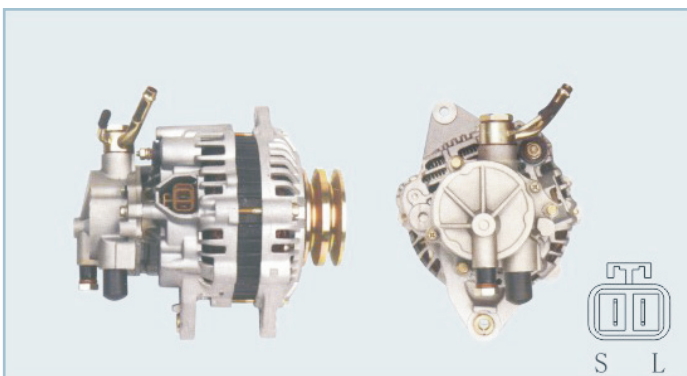
**JFZB1921B**(12V 110A)

OEM:A3T06099 A2TN0199 37300-42501

ENGINE:4D56

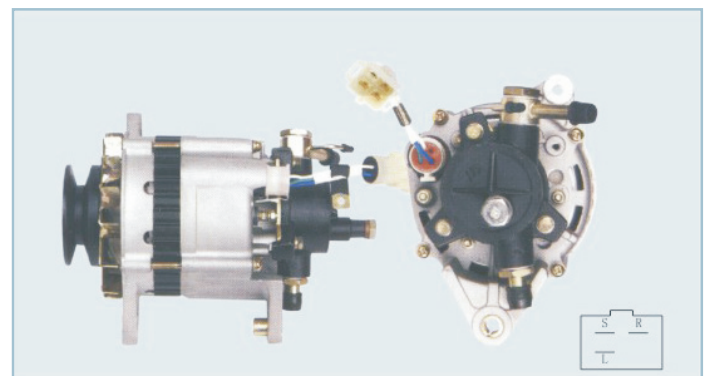
APPLICATION:MITSUBISHI DELICA 2WD  
PAJERO NT**JFZB15001**(12V50A)

OEM:14648 LR150-205 LR150-155B

ENGINE:C223

APPLICATION:ISUZU PICKUP 2.2L  
TROOPER 2.2L

## 庆元博安电机有限公司

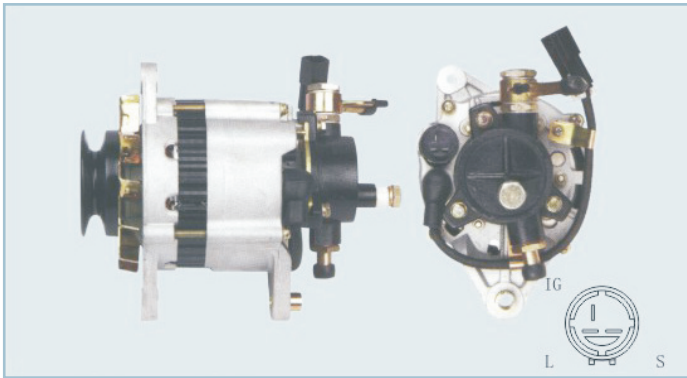
**JFZB172**(12V 70A)

OEM:22246 LR150421C LR160-418B

ENGINE:4JA1 4JB1

APPLICATION:ISUZU NKR NHR

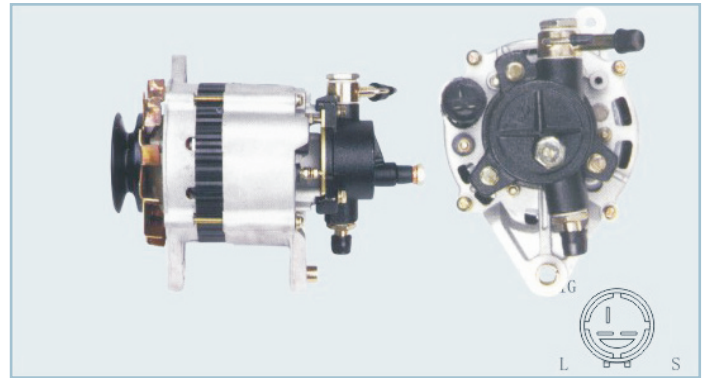
**JFZB272**(24V 35A)

OEM:LR225-408E LR225-408C LR225-411

ENGINE:4JC1 4BE1

APPLICATION:ISUZU NKR 3.3L 3.6L NPR 3.3L 3.6L 3.9L

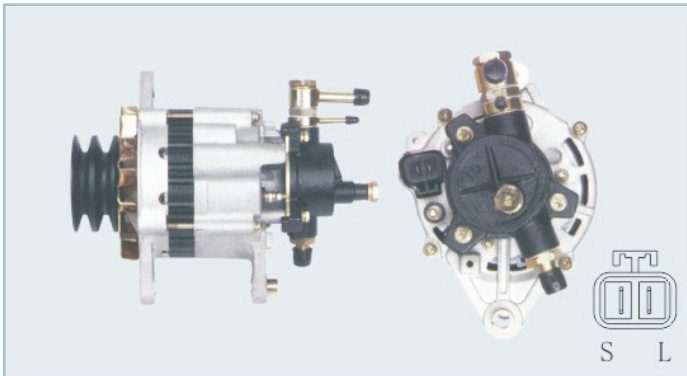
**JFZB172B**(12V 70A)

OEM:LR160-437 LR150-428T LR160-437T

ENGINE:TD27 TD25

APPLICATION:NISSAN PATROL

NISSAN NAVARA LARGO VAN

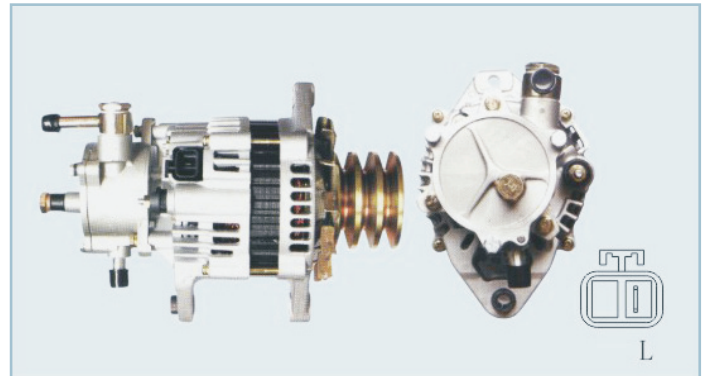
**JFZB252**(24V 50A)

OEM:LR250-517 LR250-511B 810600-821-6

ENGINE:4HF1

APPLICATION:ISUZU JAMBO

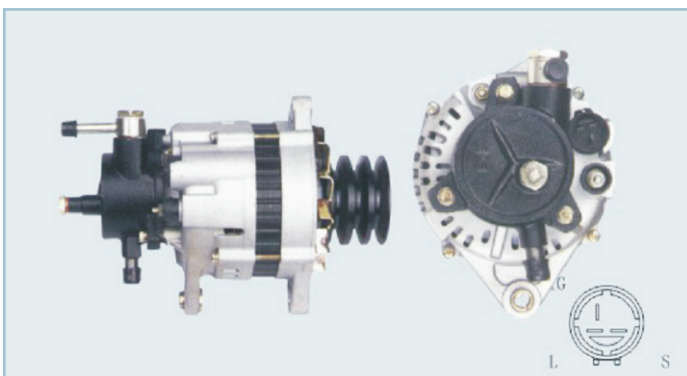
**JFZB253**(24V 60A)

OEM:LR260-504B 8-97175-390-1

ENGINE:4HF1 4HE1

APPLICATION:ISUZU NPR NKR

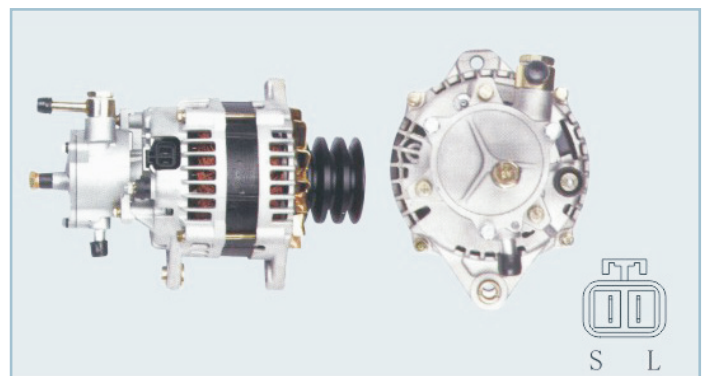
**JFZB282**(24V 80A)

OEM:LR280-508 LR280-501 8-97351-574-0

ENGINE:4HF1 4HG1 4HJ1

APPLICATION:ISUZU NPR NKR

## 庆元博安电机有限公司

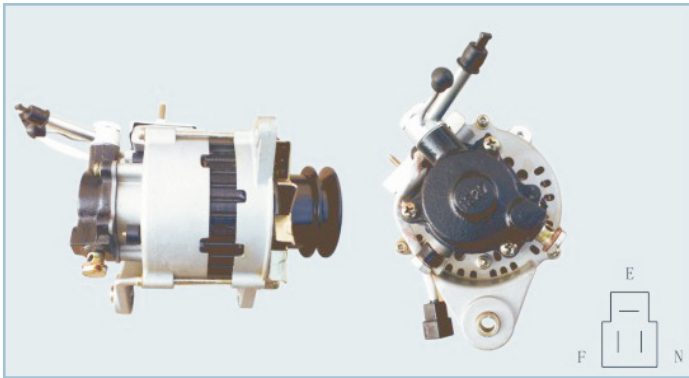

### JFB1719 (12V 70A)

OEM:27020-54250 27020-54220

ENGINE:N/A

APPLICATION:TOYOTA LAND CRUISER(\_J7\_)

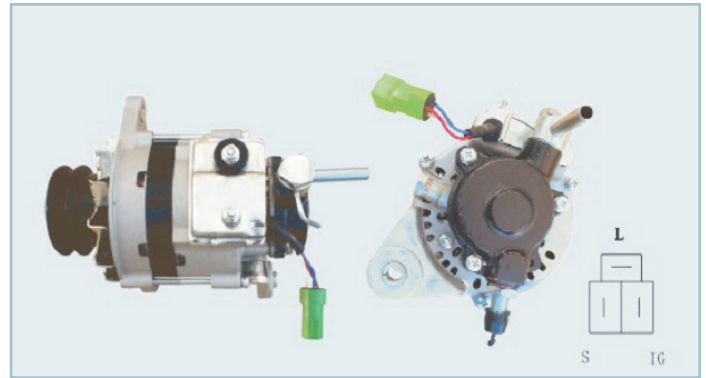

### JFZB1719A (12V 70A)

OEM:27030-54130

ENGINE:N/A

APPLICATION:TOYOTA LAND CRUISER(\_J7\_)

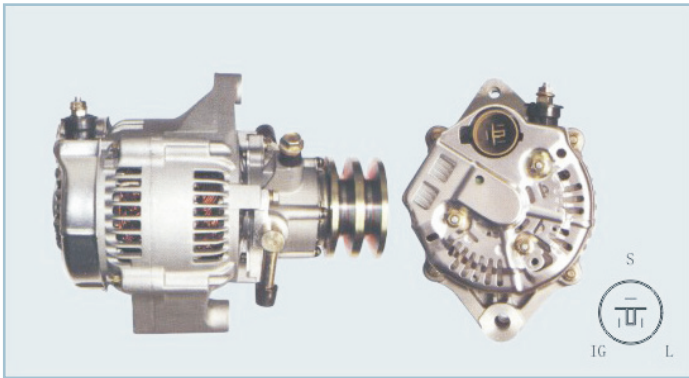

### JFZB1730 (12V 70A)

OEM:27040-54240

ENGINE:3L

APPLICATION:TOYOTA

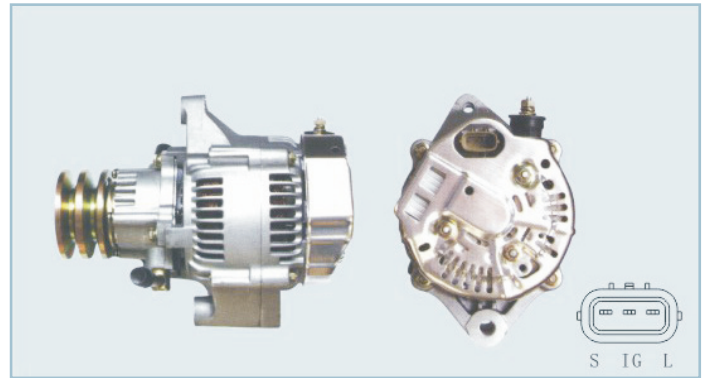

### JFZB1730B (12V 70A)

OEM:27040-54440 100213-2471

ENGINE:3L

APPLICATION: TOYOTA

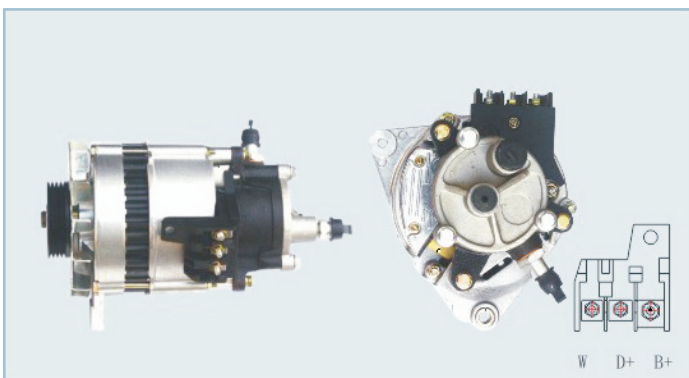

### JFZB1711 (12V 70A)

OEM:5106 5026727 1658022

ENGINE:N/A

APPLICATION:FORD TRANSIT BUS(T\_)



### JFZ1602 (12V 45A)

OEM:23821 LRA100 LRA106

ENGINE:N/A

APPLICATION:VAUXHALL CHEVETTE ESTATE

## 庆元博安电机有限公司

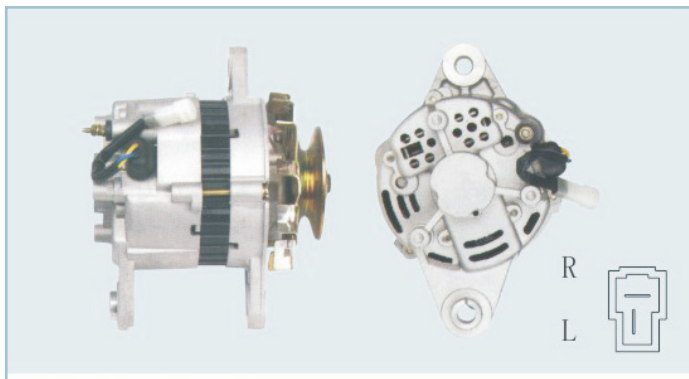
**JFZ2301A**(24V 35A)

OEM:12431 A002T7189 A5T70383

ENGINE:4D30 4DR5

APPLICATION: MITSUBISHI INDUSTRIAL ENGINE

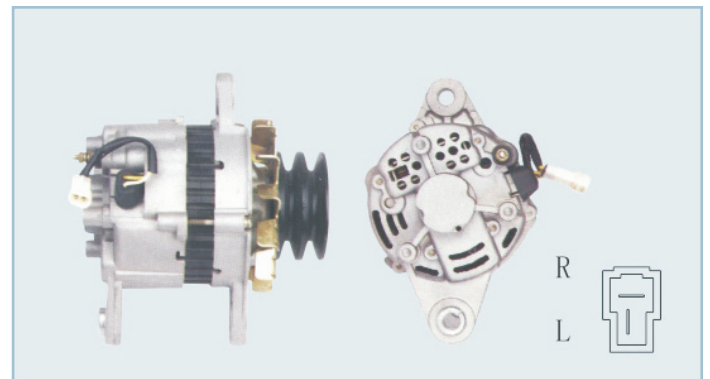
**JFZ2301B**(24V 35A)

OEM:A002T72999

ENGINE:6D16

APPLICATION: MITSUBISHI TRUCKS

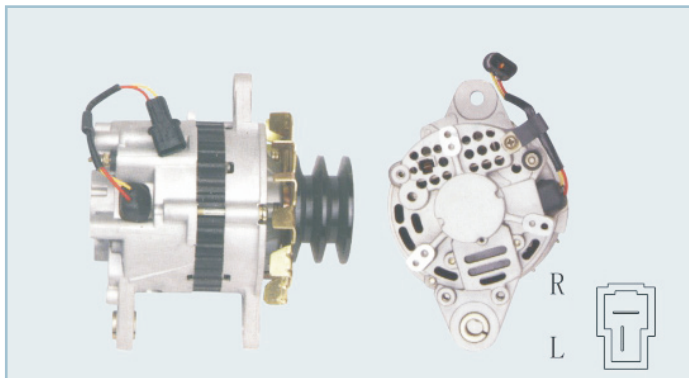
**JFZ2303**(24V 35A)

OEM:12312 A2T70772 A2T72185

ENGINE:6D14 6D16

APPLICATION: MITSUBISHI TRUCKS KATO

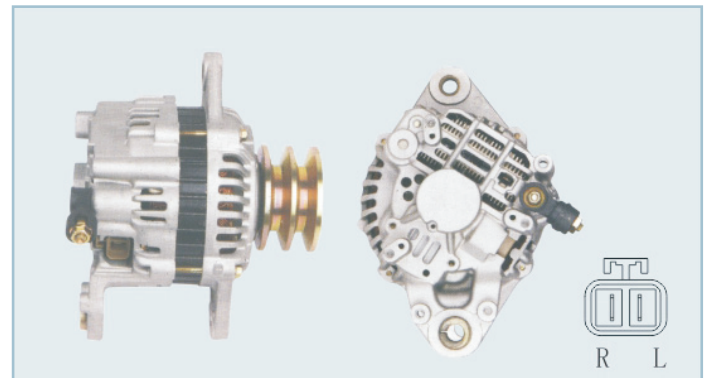
**JFZ2401**(24V 45A)

OEM:A4T40286 A3TN5386 A4T40299

ENGINE:6D16 6D40

APPLICATION: MITSUBISHI FUSO FE MMC TRUCK

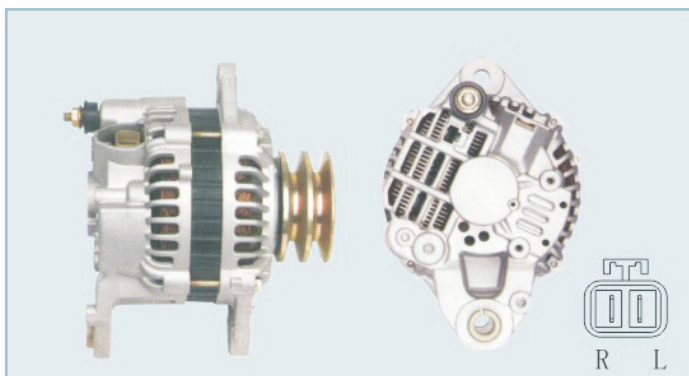
**JFZ2402**(24V 45A)

OEM:A3TN5288 A3TN5188 ME037620

ENGINE:4D33

APPLICATION: MITSUBISHI CANTER Fe317 337 437 447

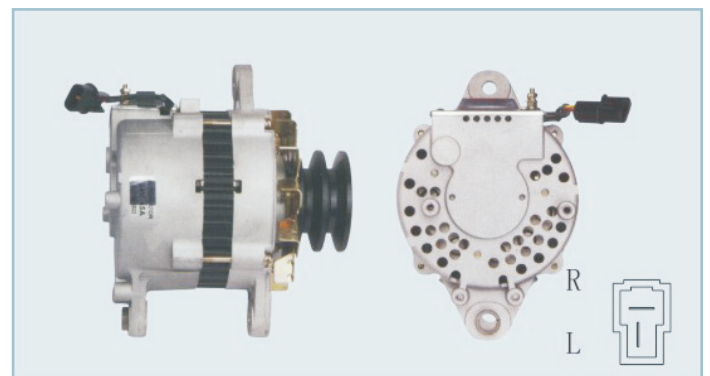

## JFZ2403(24V 45A)

OEM:A4T40386

ENGINE:6D22 6D22T

APPLICATION: MITSUBISHI FK337 415 416 417 419  
515 516 FM515 MP117 118 FU478

## 庆元博安电机有限公司

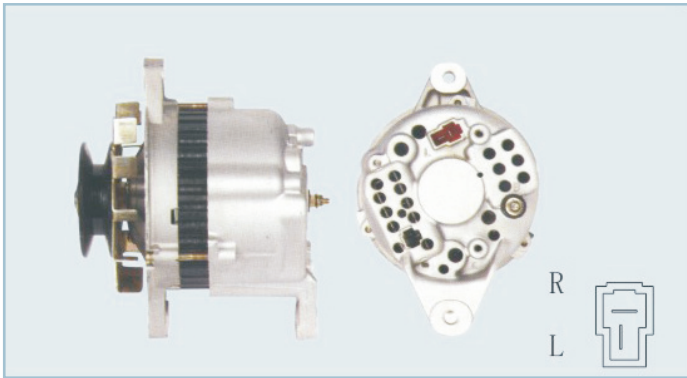
**JFZ136**(12V 35A)

OEM:14687 A1T25083

ENGINE:S4E 4DQ

APPLICATION:MITSUBISHI LIFT-TRUCKS

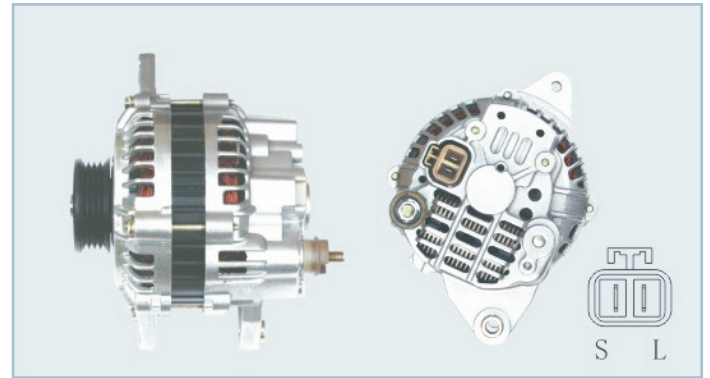
**JFZ1929**(12V 90A)

OEM:37300-22600

ENGINE:N/A

APPLICATION:HYUNDA ELANTRAI

**JFZ1929C**(12V90A)

OEM:

ENGINE:N/A

APPLICATION:HYUNDA ELANTRAI

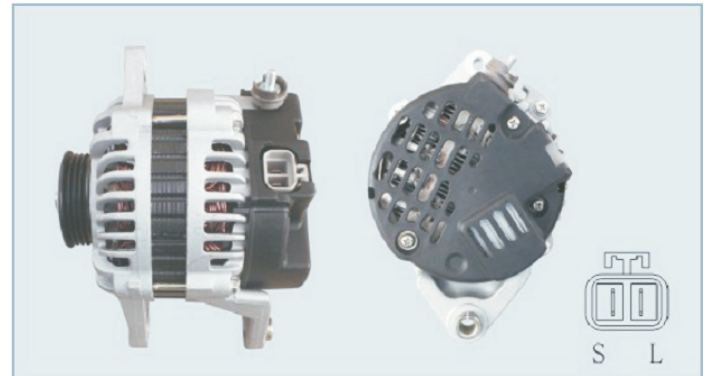
**JFZ1964**(12V 90A)

OEM:13948 OK30D-18-300

ENGINE:N/A

APPLICATION:KIA RIO ESTATE(DC)

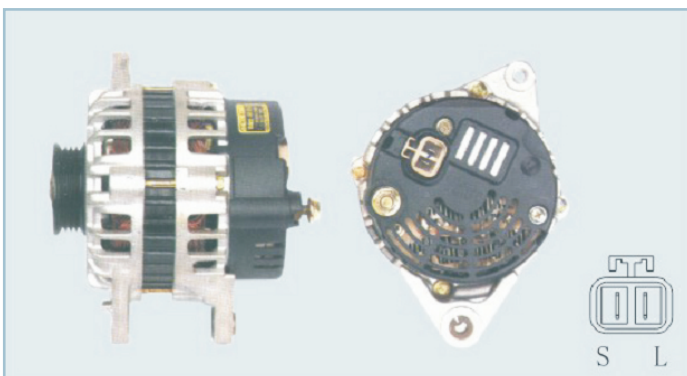
**JFZ1964A**(12V 90A)

OEM:13839 37300-22600 AB180128

ENGINE:N/A

APPLICATION:HYUNDAI ACCENT

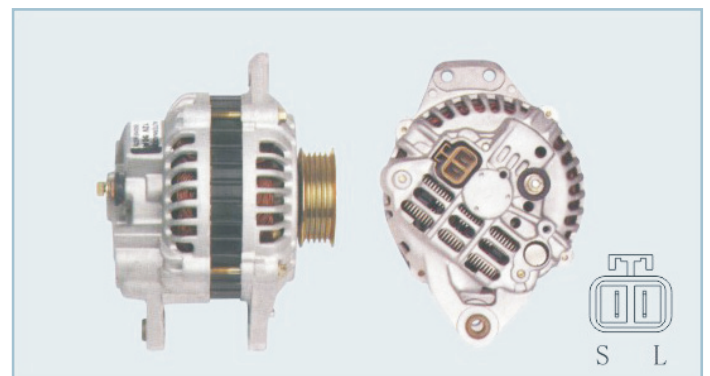
**JFZ1972**(12V 90A)

OEM:13257 A3T02193 A3T08293

ENGINE:6G72

APPLICATION:MITSUBISHI MONTERO 3.0L PAJERO V6  
DODEG COLT VISTA 2.4L

## 庆元博安电机有限公司

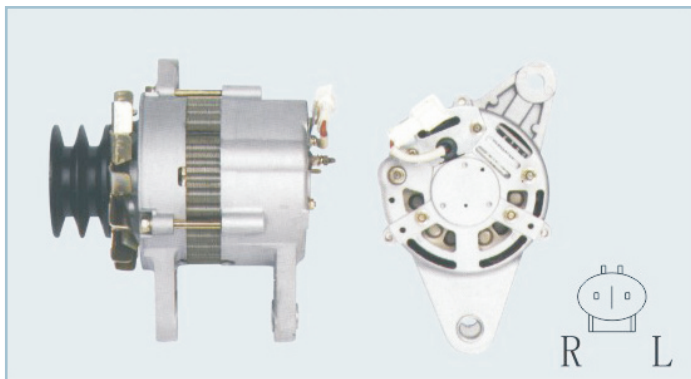

### JFZ2218A (24V 35A)

OEM:12360 033000-6552 1-81200-440-2

ENGINE:6BD1T

APPLICATION:ISUZU INDUSTRIAL MISC INDUSTRIAL EQUIPMENT

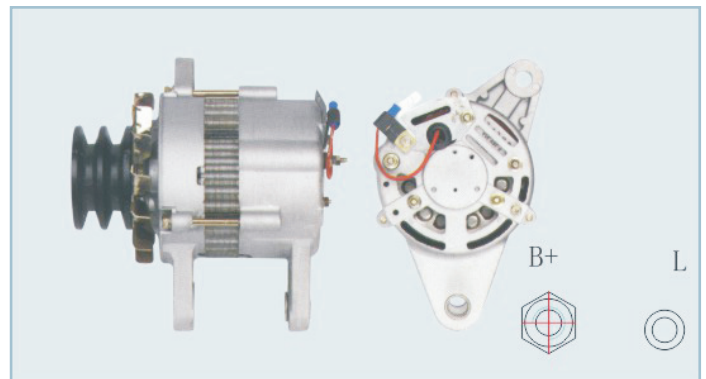

### JFZ2218B (24V 35A)

OEM:12267 033000-6000 181200-3650

ENGINE:6BD1 6BB1

APPLICATION:EX200-1 TCM FD35Z 38Z 40Z 45Z 50Z 60Z 70Z

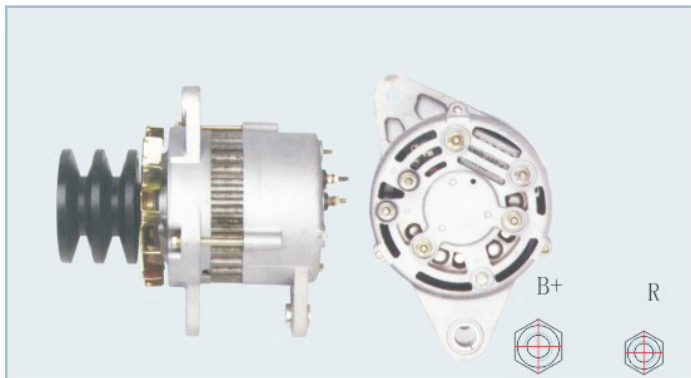

### JFZ2219A (24V 35A)

OEM:12251 033000-5880 600-821-6150

ENGINE:S6D125

APPLICATION:PC300

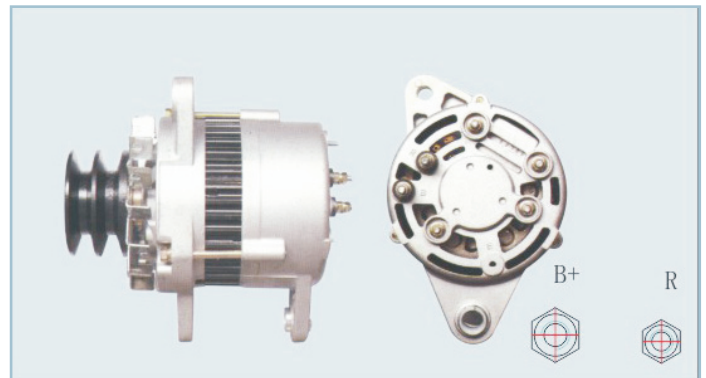

### JFZ2219B (24V 35A)

OEM:12251 0-33000-5840 600-821-6130

ENGINE:S6D105

APPLICATION:PC200-5

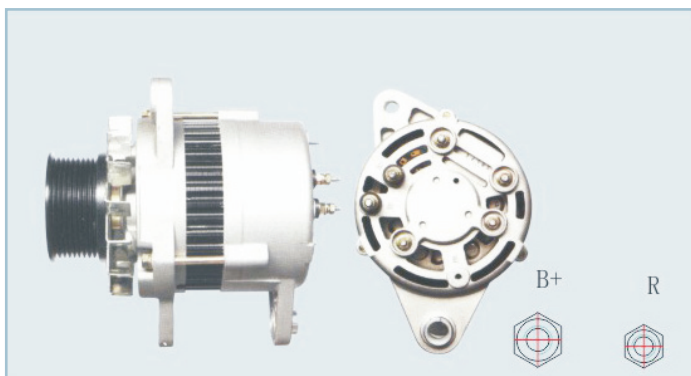

### JFZ2219C (24V 35A)

OEM:12252 0-33000-6580

ENGINE:S6D95L S6D120

APPLICATION:PC200-6

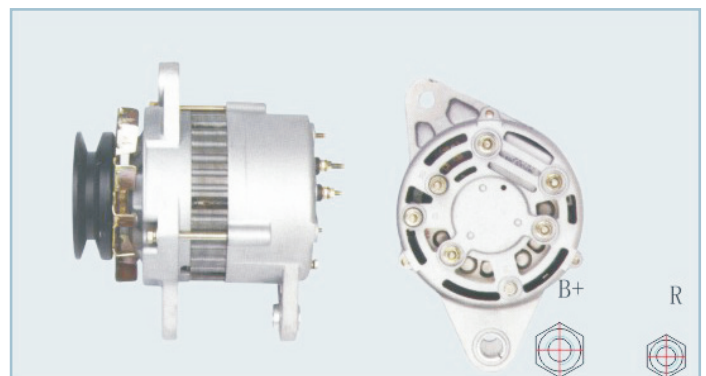

### JFZ2219D (24V 35A)

OEM:12260 600-821-6120 ALT29000

ENGINE:4D95 6D95 6D105

APPLICATION:PC100 PC120 PC150 PC200 PC220 PC60B PW200 WA40 GD200 GD300

## 庆元博安电机有限公司

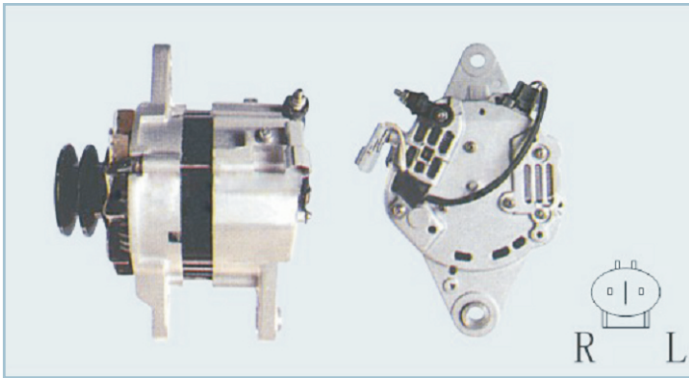

### JFWZ2501 (24V 50A)

**OEM:**A4TU5486 181200-5303  
**ENGINE:**6BG1  
**APPLICATION:**ISUZU FSR113  
 HITACHI EX200-6 ZX200

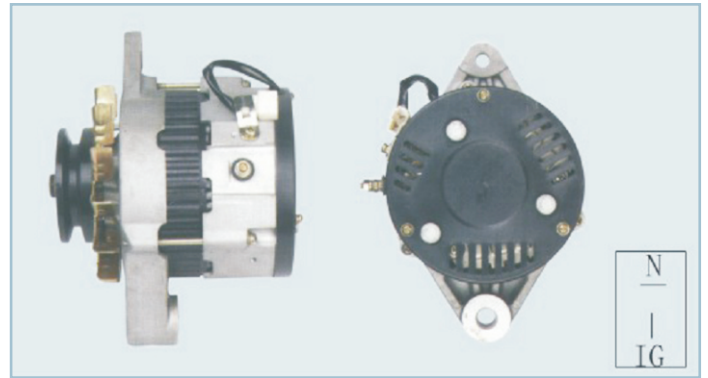

### JFWZ2502 (24V 60A)

**OEM:**0201-102-1011 0201-102-1810 0201-102-010  
**ENGINE:**EP100 EK100  
**APPLICATION:**HINO TRCKS FS FN FR P-FS SH

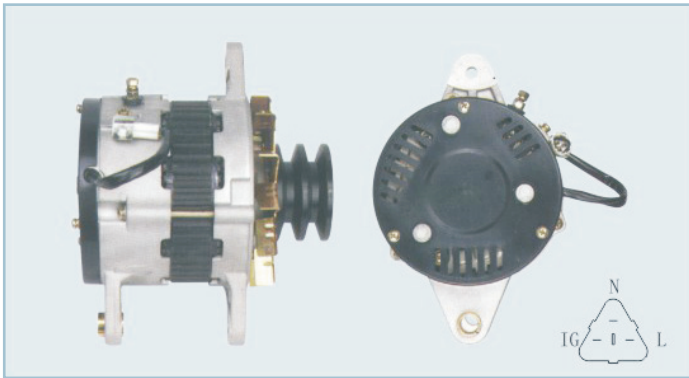

### JFWZ2503 (24V 60A)

**OEM:**0201-102-3011 0201-102-3010 27040-1751A  
**ENGINE:**H07D W06E  
**APPLICATION:**HINO U-FD2H U-FF2H U-FD3W 3H

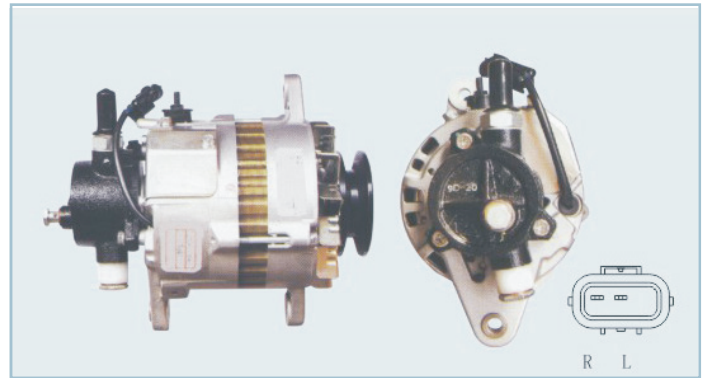

### JFZB2304 (24V 35A)

**OEM:**27050-1112A  
**ENGINE:**N/A  
**APPLICATION:**HINO

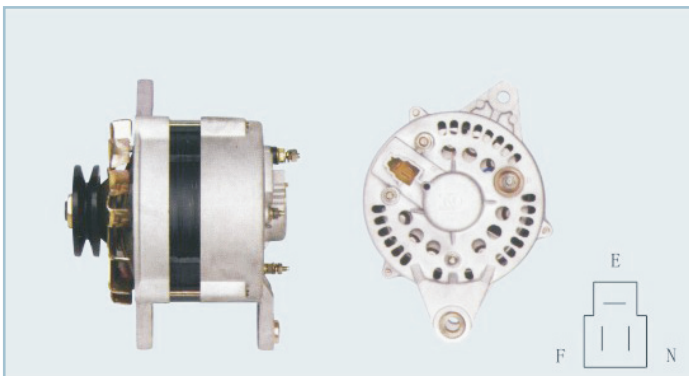

### JF1718 (12V 55A)

**OEM:**201000-1361 021000-0470 27020-22021  
**ENGINE:**4K 2F 21R  
**APPLICATION:**TOYOTA

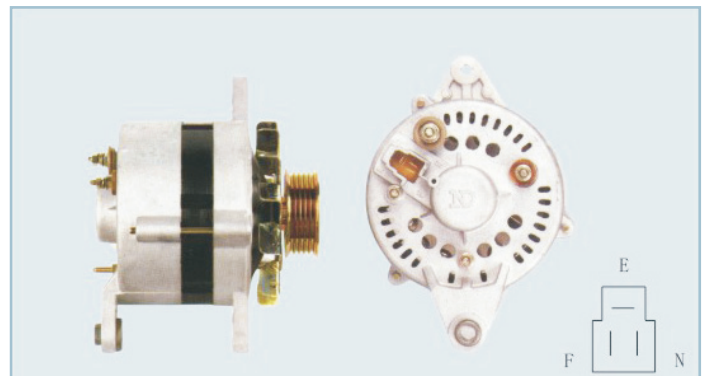

### JF1718C (12V 55A)

**OEM:**021000-9080 021000-9040 1-1014-01ND  
**ENGINE:**N/A  
**APPLICATION:**TOYOTA



## 庆元博安电机有限公司

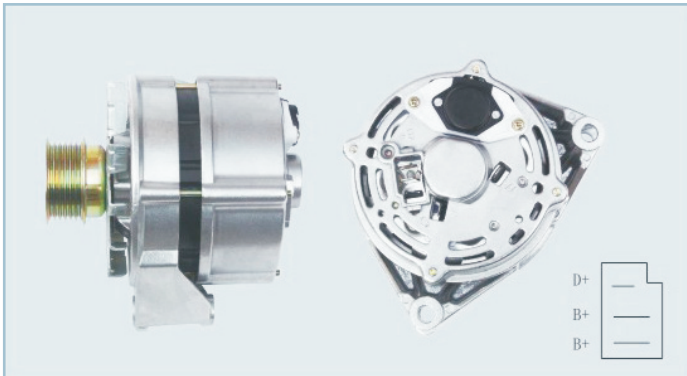

### JFZ1572 (12V 55A)

OEM:0120489324 E.D.R:933740

ENGINE:N/A

APPLICATION:MERCEDES-BENZ COUPE(C124)

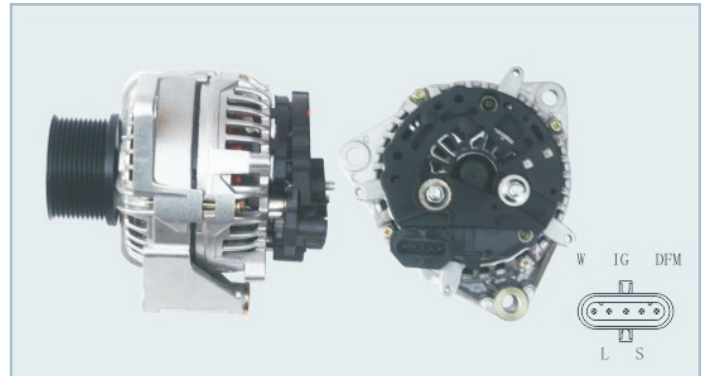

### JFZ2857 (28V 80A)

OEM:12387 0124555004 0124555001

ENGINE:N/A

APPLICATION:MERCEDES-BENZ ACTROS

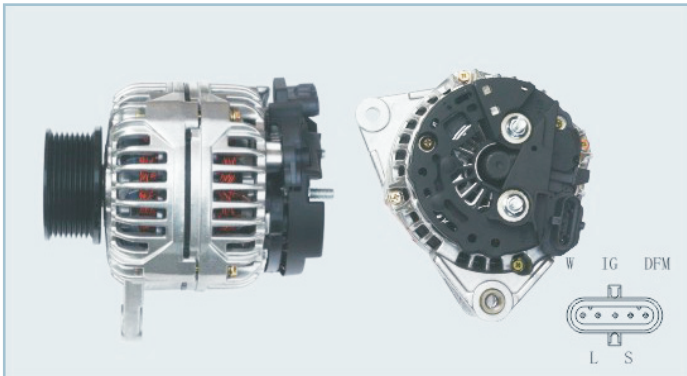

### JFZ2858 (24V 80A)

OEM:12591 0124555005 1-2903-01B0

ENGINE:N/A

APPLICATION:IVECO EURO CARGO



### JFZ2856 (28V 80A)

OEM:12599 0124555036 098604290

ENGINE:FH

APPLICATION:VOLVO FH

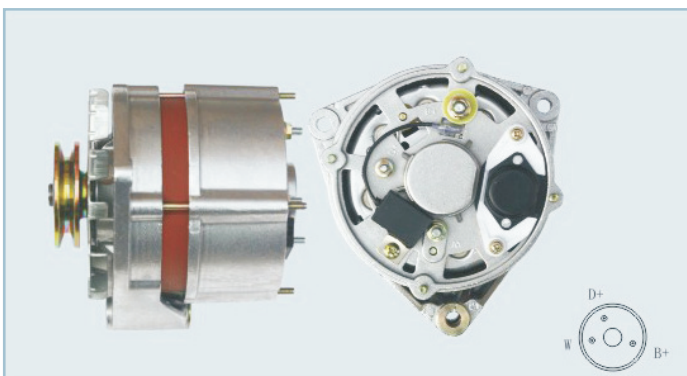

### JFZ1672 (12V 65A)

OEM:14390 0120489710 0120489506

ENGINE:N/A

APPLICATION:MERCEDES-BENZS-CLASS(W108 W109)

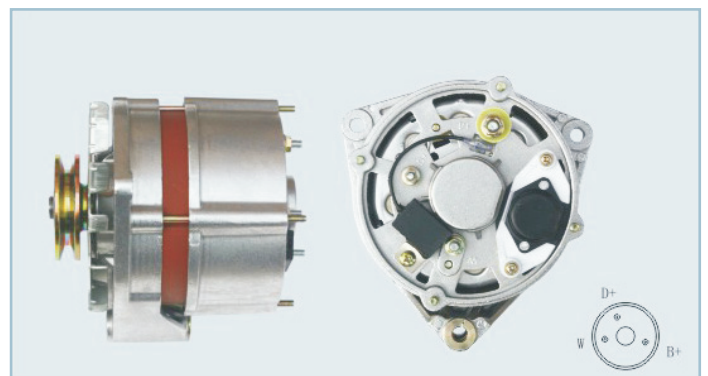

### JFZ2272 (24V 35A)

OEM:12217 0120489730 CA3411R

ENGINE:N/A

APPLICATION:MERCEDES-BENZ UNIMOG

## 庆元博安电机有限公司

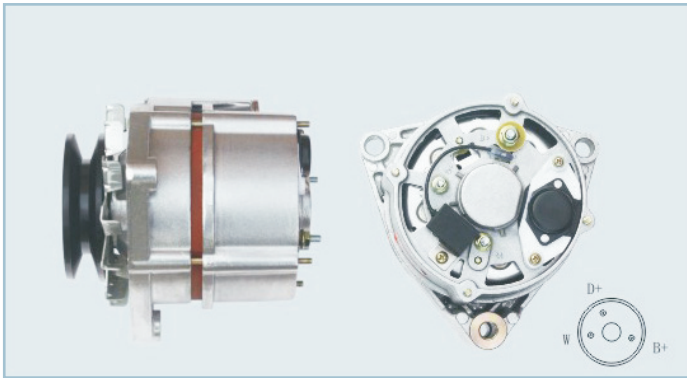

### JFZ2273 (24V 35A)

OEM: 21823 0120489728 0120489727  
 ENGINE: N/A  
 APPLICATION: MERCEDES-BENZ LK/LN2

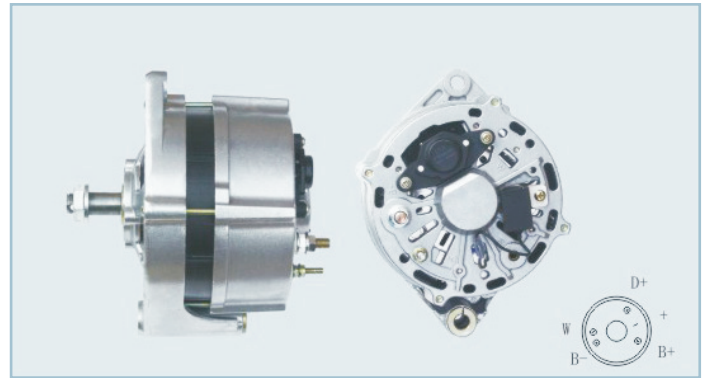

### JFZ2527 (24V 55A)

OEM: 12167 0120469569 0120469643  
 ENGINE: N/A  
 APPLICATION: SCANIA 2 SERIES 3 SERIES

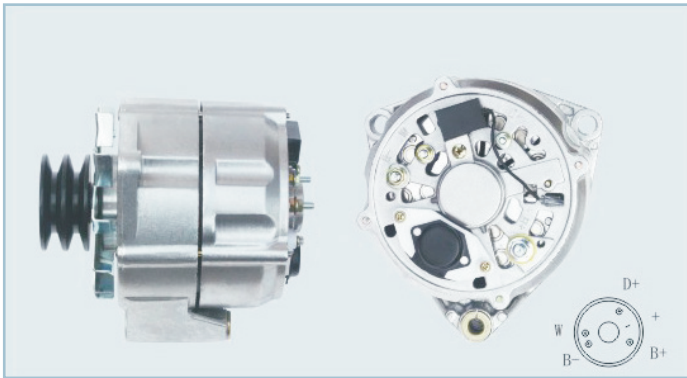

### JFZ2528 (24V 55A)

OEM: 12586 0120469982 0120469686  
 ENGINE: N/A  
 APPLICATION: MAN F2000 DAF 85

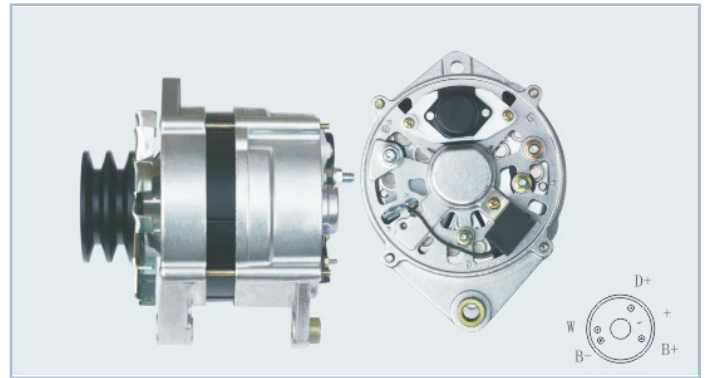

### JFZ2529 (24V 55A)

OEM: 23781 0120469920 CA550IR  
 ENGINE: N/A  
 APPLICATION: SAAB 99

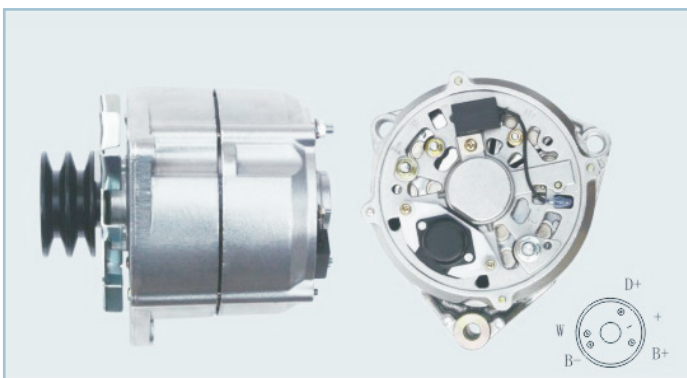

### JFZ2825 (24V 80A)

OEM: 12585 0120468053 1-2711-01BO  
 ENGINE: N/A  
 APPLICATION: MAN F 2000 DAF 85



### JFZ2827 (24V 80A)

OEM: 12571 0120468037 1-2723-00BO  
 ENGINE: FL 6  
 APPLICATION: VOLVO FL6

## 庆元博安电机有限公司

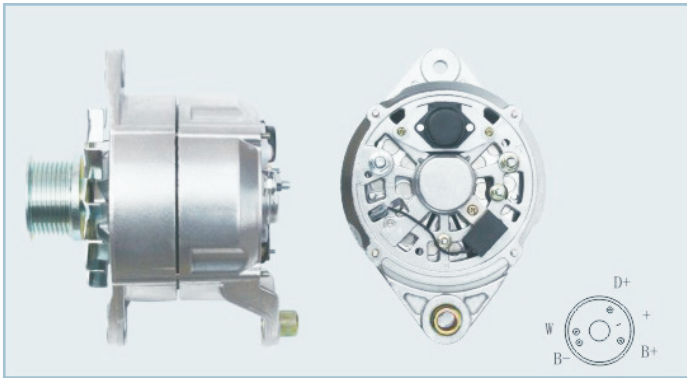

### JFZ2828(24V 80A)

OEM:12596 0120468093 0120468135  
ENGINE: B12  
APPLICATION:VOLVO B12

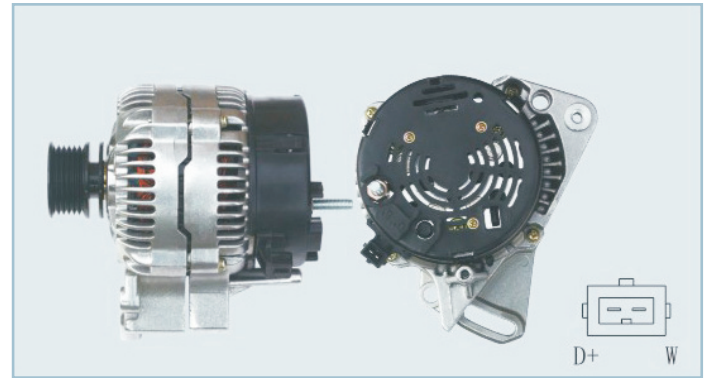

### JFZ1918(12V 90A)

OEM:13606 0123310020 028903025G  
ENGINE:N/A  
APPLICATION:VW GOLF 3 CABRIOLET(1E7)

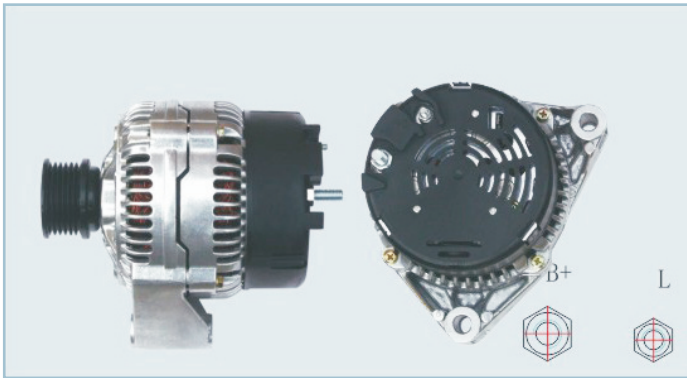

### JFZ1919(12V 90A)

OEM:13613 0123335002 1-1950-42B0  
ENGINE:N/A  
APPLICATION:MERCEDES-BENZ SALOON(W124)

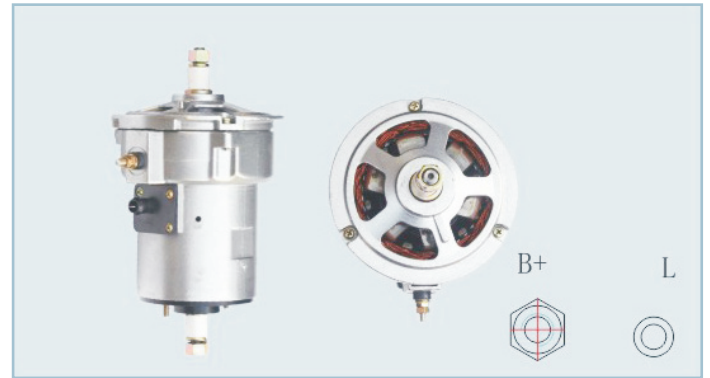

### JFZ1701(12V 55A)

OEM:13080 0120489565 1-1386-01B0  
ENGINE:N/A  
APPLICATION:VW KAEFER

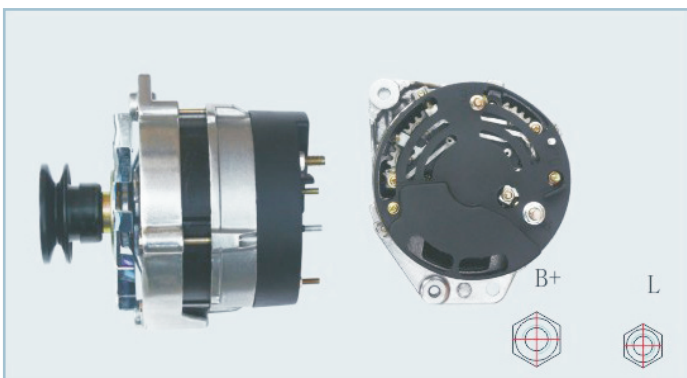

### JFZ1913(12V 90A)

OEM:14778 026903015B 0120469972  
ENGINE:N/A  
APPLICATION:VW SANGTANGA

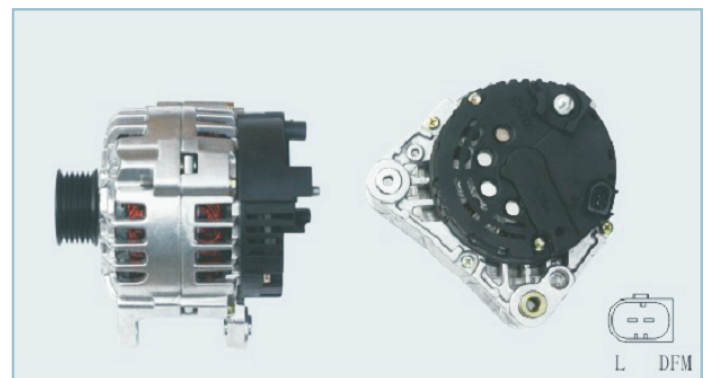

### JFZ1914(12V 90A)

OEM:13852 0124325003 1-2520-01B0  
ENGINE:N/A  
APPLICATION:VW COMES A4

## 庆元博安电机有限公司

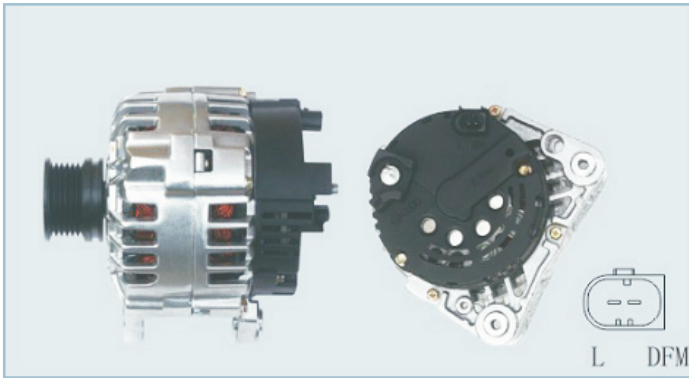
**JFZ1915**(12V 90A)

OEM:037903025

ENGINE:N/A

APPLICATION:VW POLO 1.4

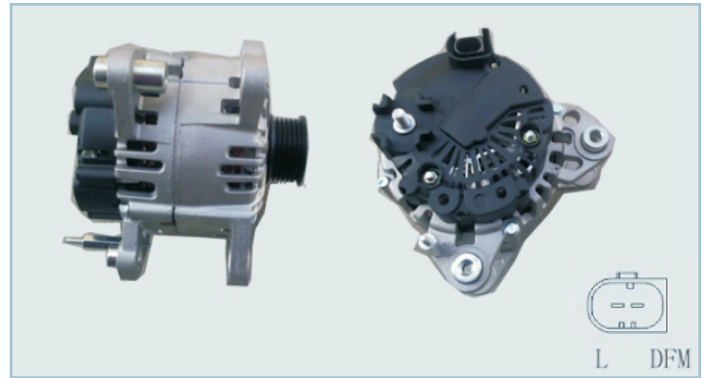
**JFZ1915B**(12V 110A)

OEM:

ENGINE:N/A

APPLICATION:VW NEW LAVIDA NEW POLO

**JFZ1211**(12V 120A)

OEM:0124515028 L0389230235

ENGINE:N/A

APPLICATION:PASSAT B5 AUDI A6

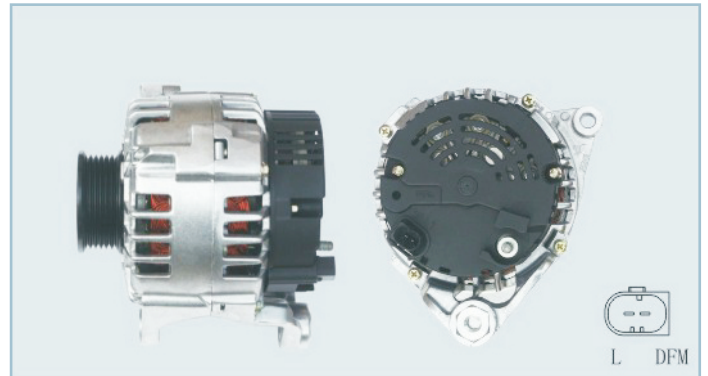
**JFZ1234**(12V 120A)

OEM:058903016M 082417

ENGINE:N/A

APPLICATION:AUDI A6

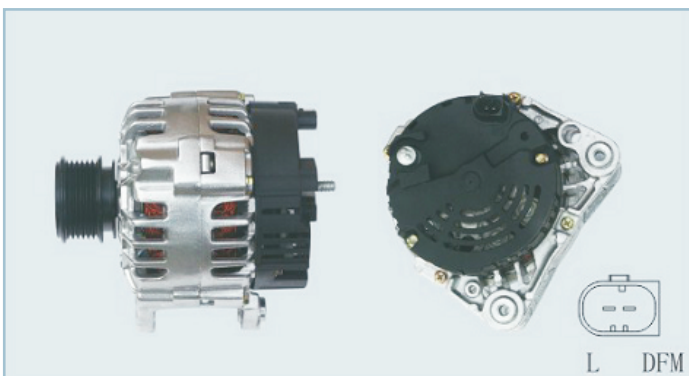
**JFZ1213**(12V 120A)

OEM:12355 L0389230235 082416

ENGINE:N/A

APPLICATION:VW POLO 1.6

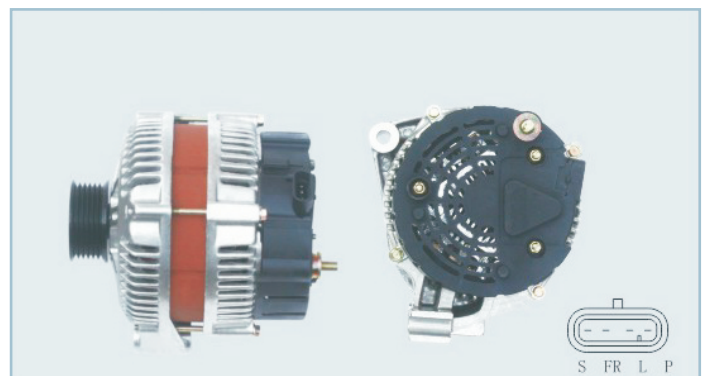
**JFZ1401**(12V 140A)

OEM:10405121 10448038 082305

ENGINE:N/A

APPLICATION:BUICK REGAL 3.0

## 庆元博安电机有限公司

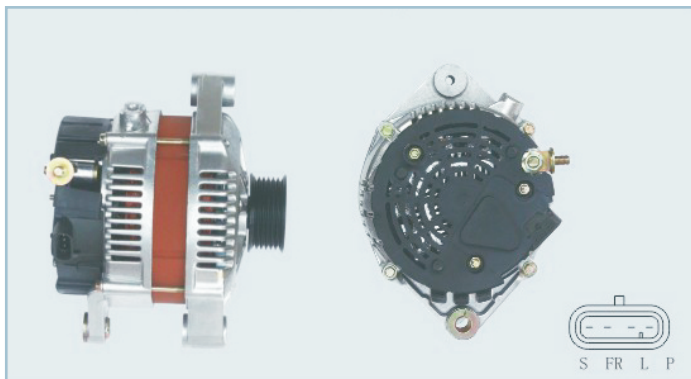

### JFZ1402(12V 140A)

OEM:5476143 082306  
ENGINE:N/A  
APPLICATION:BUICK REGAL 2.0

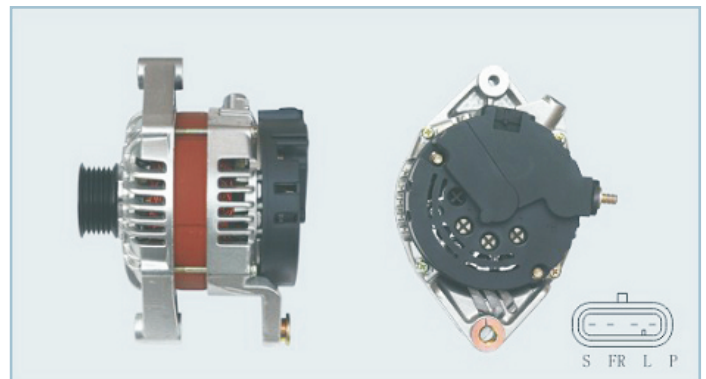

### JFZ1939(12V 95A)

OEM:5498775 082420  
ENGINE:N/A  
APPLICATION:BUICK EXCELLE 1.8

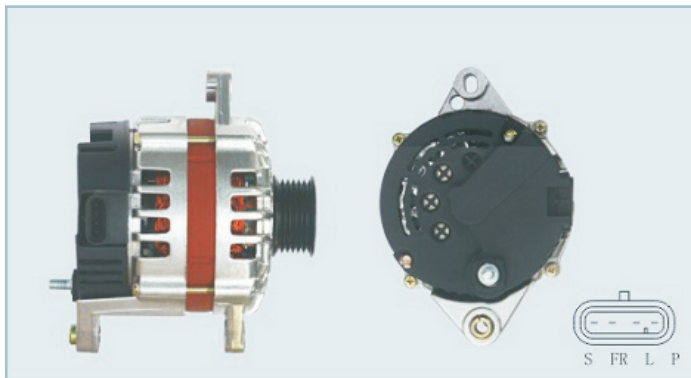

### JFZ1838(12V 85A)

OEM:5498774 082404  
ENGINE:N/A  
APPLICATION:BUICK EXCELLE 1.6

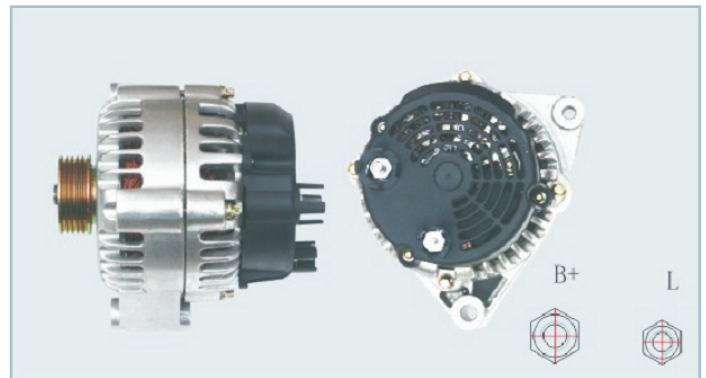

### JFZ1901(12V 90A)

OEM:DC00222880  
ENGINE:N/A  
APPLICATION:FUKANG

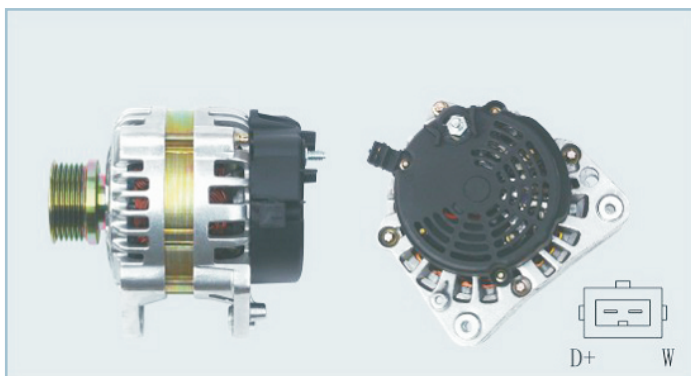

### JFZ1902(12V 90A)

OEM:13458 037903023G 439003  
ENGINE:N/A  
APPLICATION:VW JETTA

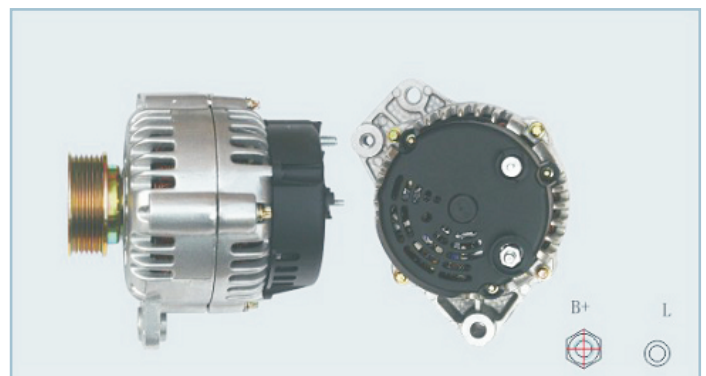

### JFZ1904(12V 90A)

OEM:3701010-BJA  
ENGINE:N/A  
APPLICATION:VW THE RED FLAG EFI

## 庆元博安电机有限公司

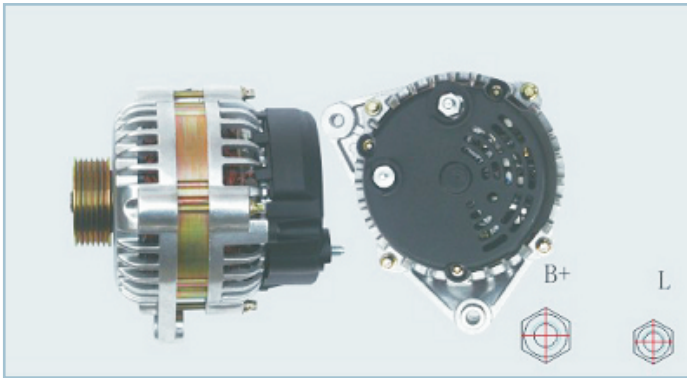

### JFZ1905 (12V 90A)

OEM:A11-3701110BA

ENGINE:N/A

APPLICATION:CHERY WIND AND CLOUD

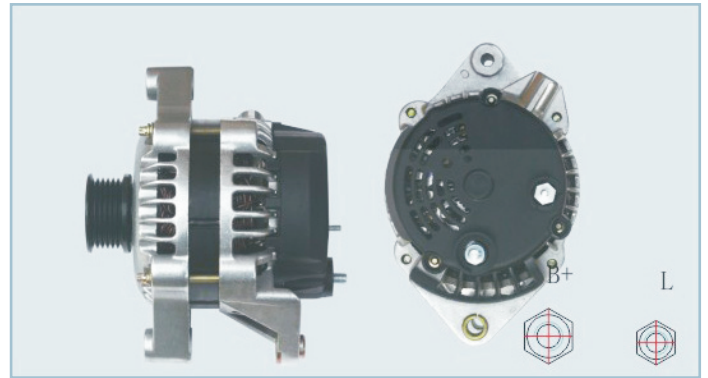

### JFZ1954 (12V 100A)

OEM:8239 6204000 1-2171-01DR

ENGINE:N/A

APPLICATION:BUICK SAIL

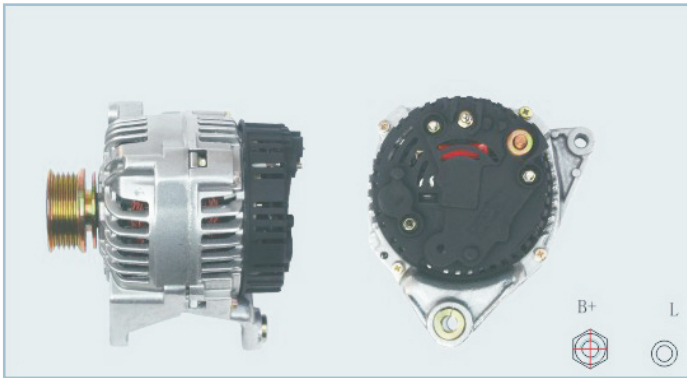

### JFZ1903 (12V 90A)

OEM:21253 058903016E 082302

ENGINE:N/A

APPLICATION:VW ERA SUPERMAN

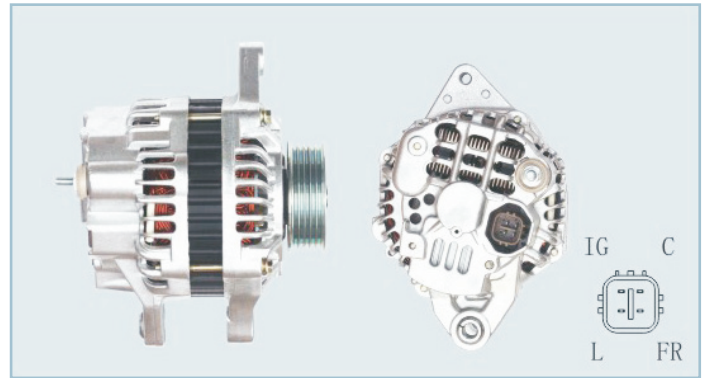

### JFZ1731 (12V 70A)

OEM:31100-REJ-W01 A50091

ENGINE:N/A

APPLICATION:HONDA FIT

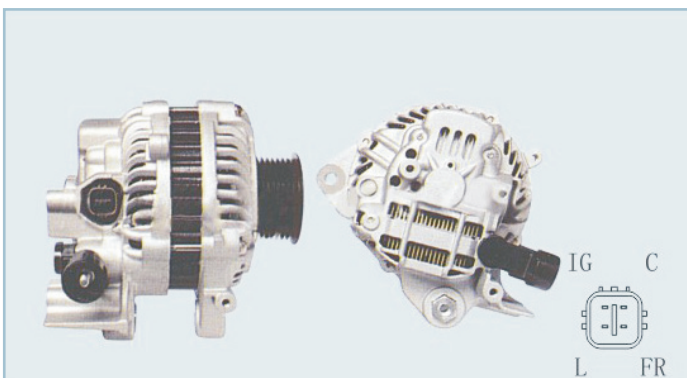

### JFZ1831 (12V 90A)

OEM:11176 A2TC1391 31100-RNA-A01

ENGINE:N/A

APPLICATION:HONDA CIVIC V4 1.8L 2006-08

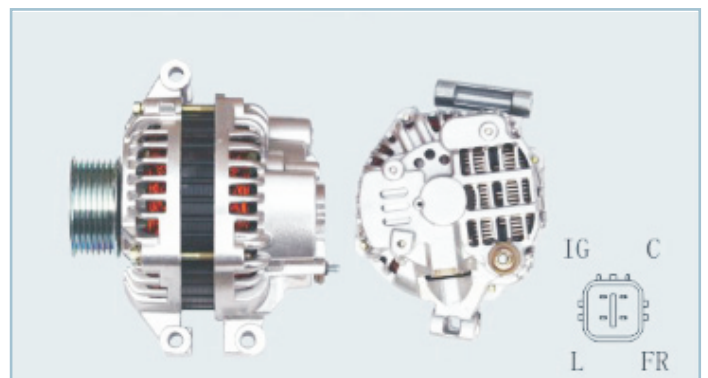

### JFZ1933 (12V 90A)

OEM:31100-PNC-004

ENGINE:K20A1

APPLICATION:HONDA CR-V 2.0L 2.4L

## 庆元博安电机有限公司

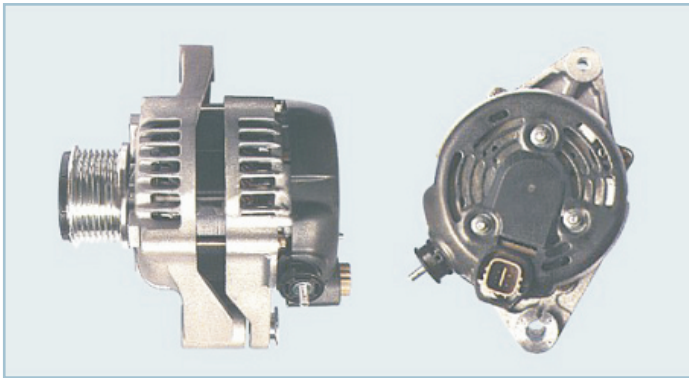
**JFZ18031**(12V 80A)

OEM:27060-0L020 27060-0L021 27060-0L022

ENGINE:N/A

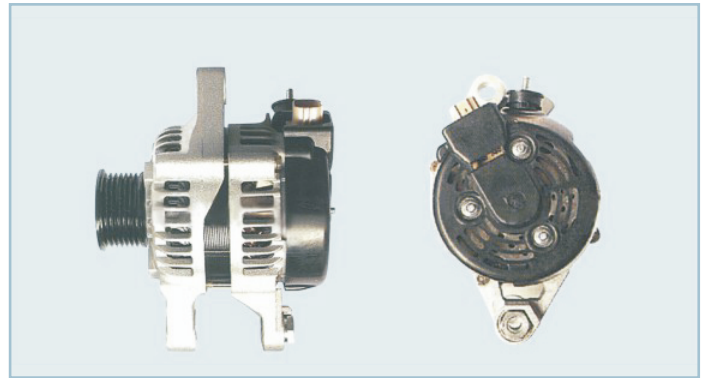
APPLICATION:TOYOTA VIGO 2005  
TOYOTA HILUX 2.5D-4D**JFZ18032**(12V 80A)

OEM:27060-0C020 104210-900

ENGINE:N/A

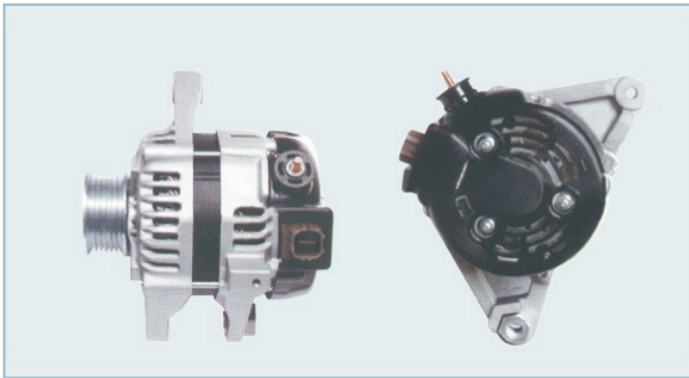
APPLICATION:TOYOTA FORTUNA 2.7L 2005-  
TOYOTA INNOVA 2006-07**JFZ18033**(12V 80A)

OEM:27060-0D060 104210-9210

ENGINE:F5A

APPLICATION:SUZUKI DAIHATSU TOYOTA

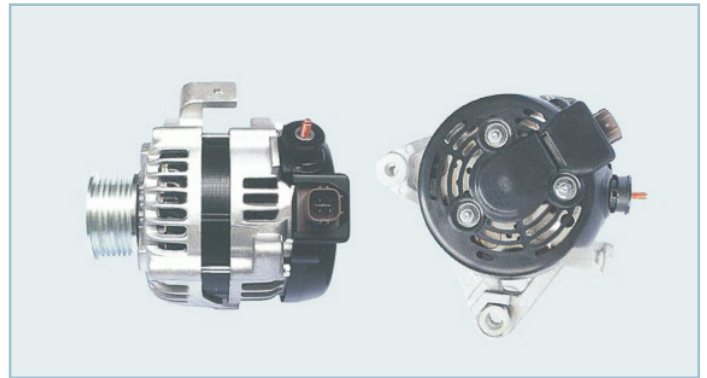
**JFZ18034**(12V 80A)

OEM:27060-0H140 104210-9040

ENGINE:N/A

APPLICATION:TOYOTA CAMRY 2.0LAZFE ACV41

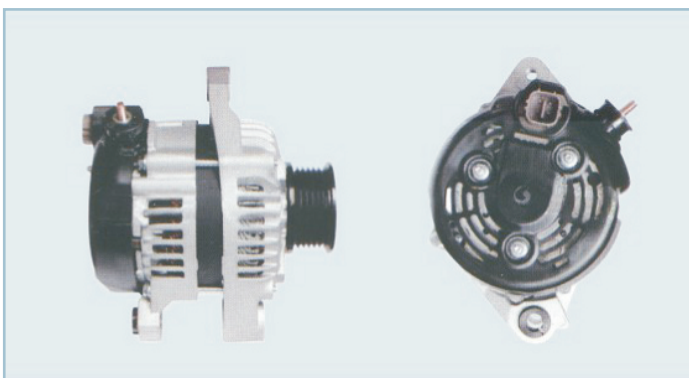
**JFZ18035**(12V 80A)

OEM:27060-0J070 104210-9110

ENGINE:N/A

APPLICATION:TOYOTA VIOS

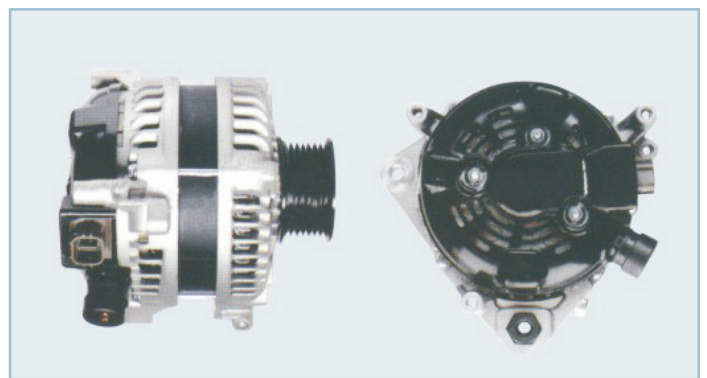
**JFZ19031**(12V 130A)

OEM:104210-5370 CSF37

ENGINE:N/A

APPLICATION:HONDA ACCORD 2.0L 2008  
HONDA CRV 2.0L 2009

## 庆元博安电机有限公司

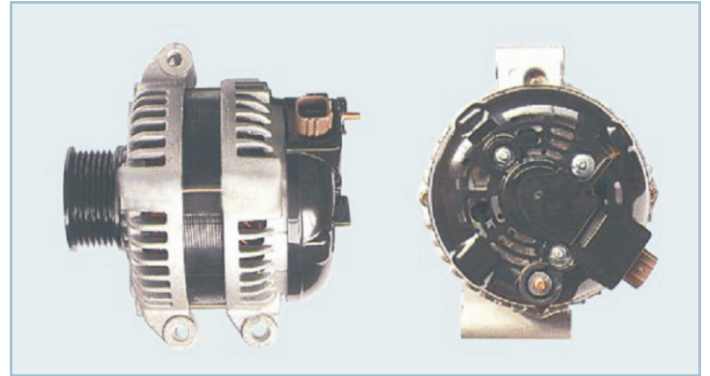
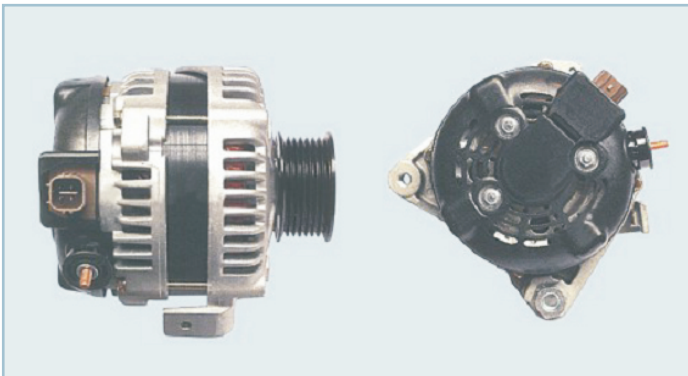
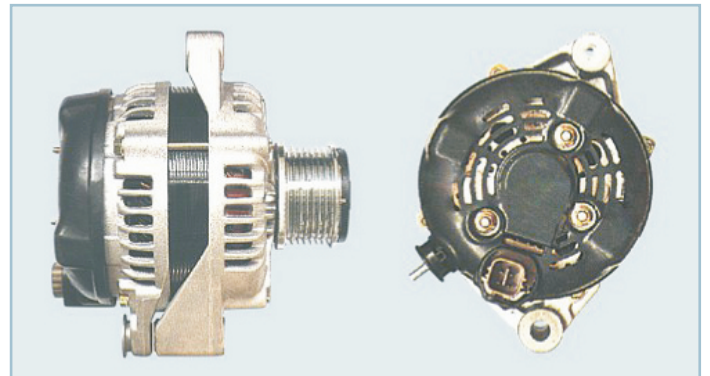
**JFZ19032**(12V 130A)**OEM:**11030 104210-3500 104210-4480**ENGINE:**N/A**APPLICATION:**HONDA ACCORD 3.0L 2004-07**JFZ19033**(12V 120A)**OEM:**13980 104210-329 104210-3290**ENGINE:**N/A**APPLICATION:**ACURA CSX V4 2.0L 2006-08  
ACURA TSX V4 2.4L 2004-08  
HONDA CIVIC V4 2.0L 2006-08  
HONDA CR-V V4 2.4L 2007-08  
HONDA ELEMENT V4 2.4L 03-08**JFZ19034**(12V 120A)**OEM:**11034 27060-0H100 27060-28270**ENGINE:**N/A**APPLICATION:**TOYOTA CAMRY V4 2.4L 2005-06  
TOYOTA SCION TC V4 2.4L 2007-08  
TOYOTA HIGHLANDER V4 2.4L 2004-07  
TOYOTA SOLARA V4 2.4L 2004-08**JFZ19035**(12V 130A)**OEM:**27060-30080 27060-30070 104210-3411**ENGINE:**N/A**APPLICATION:**TOYOTA HILUX D-4D 2.5D 2005-  
TOYOTA LAND CRUISER 3.0L D-4D 2003-